



C2-8000 Series Universal Input Seamless Switcher

User Guide V2.20

In this guide

About your C2-8000 series device.....	1
Device capabilities	1
Device features	1
General topography	1
Ultimate flexibility	1
Simple control	1
Product images.....	2
Front panel of all units.....	2
Rear panels.....	2
C2-8110	2
C2-8120	2
C2-8130	2
C2-8160	2
C2-8210	2
C2-8260	2
Unpacking and installation.....	3
Shipping carton.....	3
Important safety instructions	3
Initial operation check using factory default settings.....	3
Front panel controls.....	3
Button controls	5
Special button combinations and functions	5
Saving current settings.....	5
Locking front panel buttons and IR remote control.....	6
Restore power-on settings	6
Factory Reset	6
Video inputs and outputs.....	6
Input numbering.....	7
Computer and video inputs	8
Computer and Video outputs	8
SDI inputs and outputs	9
GENLOCK input.....	9
Audio	9
Operating modes and architecture.....	9
Switcher	10
Independent.....	10
Multi-PIP.....	11

Menu layout and settings adjustment.....	12
Group names and descriptions	13
Adjust presets menu item	13
Items associated with the adjust outputs group.....	14
Items associated with the adjust windows group	17
Extended scaling controls.....	20
‘Aspect adjust’ = ‘Advanced’	21
‘Aspect adjust’ = ‘Pixel’	21
Items associated with the adjust keyers group.....	22
Edge blend items within the adjust keyers group.....	24
Items associated with the adjust logos group	25
Items associated with the adjust borders group	26
Items associated with the adjust sources group.....	27
Menu items common to all inputs.....	27
Dvi source menu items	29
RGB source menu items	31
CV and YC source menu items	32
Still image store and testcard source menu items.....	32
Items associated with the adjust transitions group.....	33
Items associated with the adjust ethernet group	33
Items associated with the adjust resolutions group.....	35
Important cautionary information	35
Items associated with the system group.....	37
Edge-blending setup	41
Introduction.....	41
Edge-blending requirements	41
Basic setup of the two projectors.....	42
Connections to the scaler(s) and projectors	42
Initial setup	43
Edge-blending activation	44
Edge-blending overlap / size	44
Edge-blending guide lines	45
Alignment of projectors	46
Gamma correction.....	47
Brightness compensation.....	47
Aspect ratio adjustment	48
Locking both outputs together	48
Other setup approaches.....	48
3D video.....	51

General information.....	51
Frame packed 3D video resolutions	51
Scaling of 3D resolutions using a single CORIO2 scaler	51
Scaling of 3D resolutions using two CORIO2 scalers	52
2x Camera inputs to 3D resolutions using two CORIO2 scalers	53
3D resolutions to 2x Projectors using two CORIO2 scalers	54
3D Picture-in-Picture	55
Other types of 3D resolution / Transcoding between them.....	56
CORIO2 units suitable for 3D processing.....	56
Serial port	57
Connection	57
Communications protocol.....	57
Ethernet port.....	58
Connection	58
Serial / IP control specification	58
Communication protocol basics.....	58
Packet format.....	59
Function list	61
Examples.....	74
Reading and writing macros	75
Reading a previously stored Macro.....	75
Writing to a macro	76
Run and Restore macros	76
Emulate a front panel button press	77
Reset command	83
Common operations.....	84
Operation of the keyer.....	84
Preparation:.....	84
Adjustment:	84
Troubleshooting and FAQs	85
There is no picture on the Output.....	85
The image is shifted and not fully viewable.....	85
The output resolutions no longer appear as expected.....	85
There is excessive flicker on the Output.	85
The Output image is distorted.....	85
Some colors appear to be incorrect on the CV/YC output.....	85
How can I reduce color smearing on CV connections?.....	85
I can no longer adjust the Output image resolution.....	86
The picture on the video display is black and white.....	86

The picture on the video display is green.	86
The RGB input is selected but the image is rolling or pink.	86
The video signal from my DVD player does not appear to work.	86
Image is flashing, snow is present, or source image does not appear.	86
General troubleshooting checklist.....	87
Returning a product for repair	88
Specifications	88
Video inputs.....	88
Reference input.....	88
Computer digital inputs	89
Analog inputs	89
Video outputs.....	89
Computer digital outputs	89
Analog outputs.....	89
SDI inputs and outputs	89
Audio module.....	90
Locking/Mixing	90
Scaling / sampling / memory.....	90
Reliability.....	90
Regulatory Compliance.....	90
Environmental.....	90
Power Requirement	91
Control Methods.....	91
Accessories Included	91
Mechanical.....	91
Contact us.....	91

About your C2-8000 series device

Device capabilities

The C2-8000 Series uses the proprietary CORIO®2 Engine to perform its functions, being the second generation of the successful CORIO® products. The CORIO®2 technology is a powerful toolset for any application requiring high quality video signal conversion or image manipulation.

The unit features a dual-channel architecture with three video processing and scaling engines. Advanced video mixing, keying, edge-blending and seamless switching capabilities are supported.

These functions allow the flexibility for handling a wide range of inputs and outputs, depending on the unit used. Audio input, routing and output is available for HDMI and (optional) SDI connections. An optional Audio module also allows audio delay and AES3-id compatibility to support the A2-7300 range of units.

Supports DVI and HDMI resolutions up to 1920x1200@60Hz, 3G-SDI (depending on unit), Composite Video, YC (S-Video), YUV/YPbPr, and HDCP on DVI/HDMI inputs and outputs.

The DVI input and outputs on the unit provide the extra flexibility of DVI-U functionality, this provides the same connectivity as a DVI-I connection but with the additional provision of Composite and YC video.

Device features

General topography

4:4:4 RGB / YUV sampling provides full bandwidth color which allows precise keying where included in the unit's capabilities. This can be achieved through the transparent (soft) keys on the front of the unit. Each unit's video inputs accommodate multiple video and computer signal formats and resolutions – see specifications at end of manual for full details.

Ultimate flexibility

The output signal format flexibility assures that the native resolution of virtually any display can be matched. Because of the resolution calculator (included in the CORIOtools Suite), even new resolutions can be added to the unit. Signal parameter adjustments can be made for each video input and are stored in individual non-volatile memories for retrieval once the unit's power has been removed. The video scaler units employ pixel adaptive motion compensation to de-interlace fast moving images, and automatic 3:2 pull-down efficiently de-interlaces video from 24 fps NTSC film.

Simple control

The unit can be controlled in various ways. One option is to control it from the front panel using the keys on the front of the unit. It can also be controlled via RS-232/422/485 or via Ethernet using the CORIOtools Suite.

The CORIOtools Suite is available for download from our internet site and affords complete control of the unit.

Upgradeability

The unit also benefits from firmware upgradeability, thus reducing product obsolescence by allowing the installation of the latest version of firmware. This not only applies to the software used to control the unit, but also to the range of resolutions stored inside the unit, the addition of new features, and upgrades to the heart of the image processing hardware – the CORIO®2 scaling engine. See tvone.com/support for more detail.

Product images

Front panel of all units



Rear panels

C2-8110

6x DVI-U inputs, 2x DVI-U outputs, 1x Ref+loop



C2-8120

8x DVI-U inputs, 2x DVI-U outputs, 1x Ref+loop



C2-8130

12x DVI-U inputs, 2x DVI-U outputs, 1x Ref+loop



C2-8160

10x DVI-U inputs, 2x DVI-U outputs, 1x Ref+loop, Audio module



C2-8210

8x DVI-U inputs, 2x DVI-U outputs, 1x Ref+loop, 2x 3G-SDI inputs, 2x 3G-SDI outputs



C2-8260

6x DVI-U inputs, 2x DVI-U outputs, 1x Ref+loop, 2x 3G-SDI inputs, 2x 3G-SDI outputs, Audio module



Unpacking and installation

Shipping carton

Your unit will arrive double boxed for maximum protection during shipping. You are encouraged to retain both boxes and all packing material so the unit can be returned in the unlikely event that repairs should ever become necessary.

Important safety instructions

The AC power cable furnished with the unit should conform to the type in use in your country. Please compare the plug on your cable with the power socket where the unit will be installed.

If you did not receive the correct cable, **DO NOT** attempt to modify it. Instead, immediately contact your dealer or contact TV One at the sales office nearest to your geographic location and request the proper cable.

Installation should be made such that the system fans are not blocked by other pieces of equipment, and such that they may not be accidentally touched by users.

Initial operation check using factory default settings

This product can be operated via multiple methods, but for the purposes of initially acquainting you with the operation of the unit, this manual will address the operation using the Front Panel controls.

If you have problems using the unit as described below, see the 'Factory reset' description shortly afterwards.

By default, both DVI-U outputs will display a CORIO2 test image – a PC monitor can be connected to ensure that the unit is functioning properly. We'll be using a Personal Computer for a signal source and a PC monitor that can support 1024 x 768 @ 60Hz as this is the default output resolution.

Disconnect the cable going from a Personal Computer's Monitor to the Personal Computer. Connect the output from the PC video card (the PC connector formerly used by the monitor cable) to the input on the rear panel of the unit.

Next, take the cable from the PC monitor and connect it to the unit's output. Then connect the AC power cable to a working AC outlet, turn on the PC, monitor and then your unit.

Provided you have not changed anything from the Factory Defaults then your PC's image should appear on the display as normal.

Front panel controls

The range of buttons on the front of the unit provides the user with quick access for selecting a variety of inputs and features.

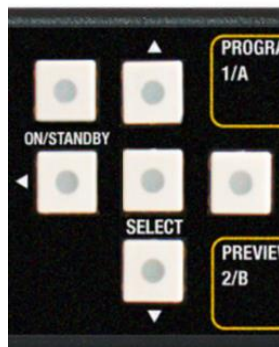

The crosshair (up/down/left/right) buttons on the front panel provides the user with a way of navigating the Liquid Crystal Display menus (LCD) which is detailed in a later section. Pressing and holding the ON/STANDBY button will place the unit into a low-power mode. A single press will turn it back on again.

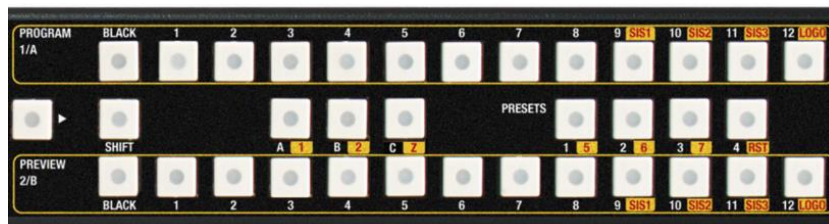

The central area of buttons are dedicated to selecting the source for Program and Preview outputs (in Switcher mode), or for Windows A and B in Independent and Multi-PIP modes.

The SHIFT button can be pressed by itself, with the following button press then selecting a function shown in red with the yellow background.

Also available are buttons to select the Window currently being adjusted (A, B, C or Z) and the Output currently being adjusted (1 or 2). Their usage changes depending on the operating mode in use.

Buttons to store and recall Presets are also present – along with a RST button to reset the unit back to factory settings (although a firmware update is the best way to perform this).

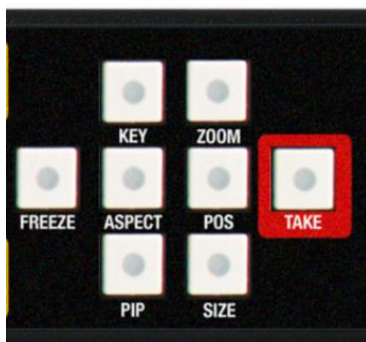

The right-hand side is reserved for Window changes and the TAKE button (used in the Switcher mode only).

Button controls

The following table describes the button usage on your unit.

Button	Button Function
Menu navigation and adjustment buttons.	Up / down / left / right / SELECT allow quick and easy access to various menu settings. Press and hold SELECT to store current settings into memory. They will then be restored on power-on, or when a Restore is done. See next section for more information.
PROGRAM 1/A Sources	Selects one of the (up to 12) input sources for display. In Switcher mode, the Program output will transition to this input without the need for TAKE to be pressed. In other modes, it selects the source to use for Window A.
PROGRAM 2/B Sources	Selects an input for display. In Switcher mode, it allows viewing of the next source on the Preview output. In other modes, it selects the source to use for Window B.
Presets 1 to 7	Recalls a preset. These start off blank, but are available to the user. Hold the button in to store the current settings in that Preset. Hold for even longer to reset that Preset back to factory defaults.
KEY	Enables keying for currently selected window – see 'Adjust keyers' menu. (Key color defaults to black, so black foreground will disappear.)
ZOOM	Jumps to the 'Zoom' menu item.
FADE	Fades out the current image – fades back in on next press.
FREEZE	Freezes the currently selected window
ASPECT	Changes the aspect ratio of the currently selected window.
POS	Jumps to the Pan or Pos menu item to allow immediate panning or positioning of the image.
PIP	Activate picture-in-picture mode for the currently selected window.
SIZE	Jumps to the 'Shrink' menu item to allow the current window to be re-sized.
ON/STANDBY	Hold in to put the unit into Standby (power-save) mode. Press once to come out of Standby mode.

Special button combinations and functions

In addition to the ability to perform a factory reset and forcing certain output resolutions, other button combinations are available:

These button combinations only work when the unit is switched on and active i.e. with the STANDBY/ON LED is off. They will not work in Standby mode, or during power-up.

Saving current settings

Press and hold the SELECT button until a beep is heard and the unit shows 'Settings stored'.

Locking front panel buttons and IR remote control

This can be performed by pressing STANDBY/ON and FREEZE at the same time. All front panel buttons and IR remote control commands will be disabled, with the exception of repeating the above combination to un-lock the unit and for storing the current locked buttons setting (thus letting you make sure the unit always starts up with the buttons locked).

The STANDBY/ON button will flash when the unit's buttons are locked.

Restore power-on settings

This can be done (without having to turn off the unit) by pressing SHIFT-RST until a single beep is heard.

Factory Reset

If you wish to restore all operational parameters to their original condition (for example, if saved settings prevent the unit from working with your display monitor), hold SHIFT-RST in together until two beeps are heard.

All stored settings except resolutions are lost when the unit is reset. A Firmware update is the only way to perform a complete factory reset (including resolution data)

Note: The 'Advanced menus' menu item must be 'On' to activate certain menu items.

Video inputs and outputs

The diagrams below show the left and right-hand halves of the rear panel of the C2-8260.

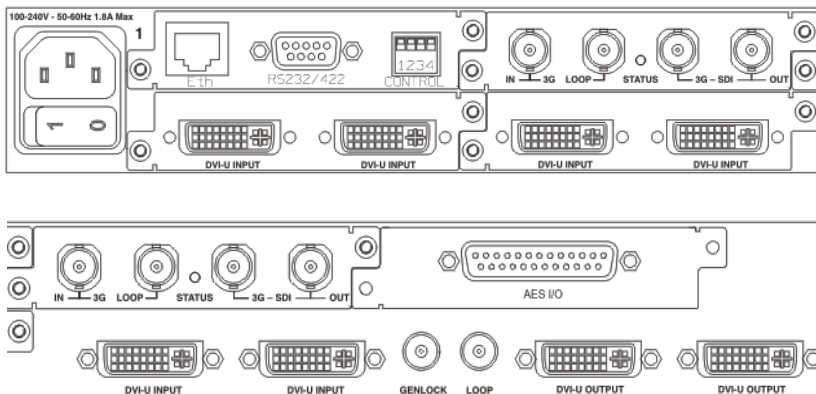

The inputs and outputs on your unit will vary depending on which product variant you have – see the product images section earlier in the manual for full details.

Input numbering

The following table shows the numbering of the sources at the rear of the unit:

C2-8110				
	6 DVI-U 5	4 DVI-U 3	2 DVI-U 1	2 OUT 1

C2-8120				8 DVI-U 7
	6 DVI-U 5	4 DVI-U 3	2 DVI-U 1	2 OUT 1

C2-8130		12 DVI-U 11	10 DVI-U 9	8 DVI-U 7
	6 DVI-U 5	4 DVI-U 3	2 DVI-U 1	2 OUT 1

C2-8160		10 DVI-U 9	8 DVI-U 7	AUDIO I/O
	6 DVI-U 5	4 DVI-U 3	2 DVI-U 1	2 OUT 1

C2-8210		IN 10 SDI OUT 2	IN 9 SDI OUT 1	8 DVI-U 7
	6 DVI-U 5	4 DVI-U 3	2 DVI-U 1	2 OUT 1

C2-8260		IN 8 SDI OUT 2	IN 7 SDI OUT 1	AUDIO I/O
	6 DVI-U 5	4 DVI-U 3	2 DVI-U 1	2 OUT 1

Computer and video inputs

The DVI-U inputs can accept:

- Digital DVI-D or HDMI signals
- Analog Composite Video
- Analog Y/C (S-Video)
- Analog RGBHV (separate syncs at TTL levels)
- Analog RGsB (sync on green)
- Analog RGSB (separate sync at TTL levels)
- Analog YUV/YPbPr (including tri-level)

For DVI-D, RGBHV, RGSB, RGsB and CV the particular input being used will be auto-detected.

For all signals except DVI-D, an adaptor cable is required for use. See 'Connector pin-outs' for more information.

CV and YC sources can be either standard NTSC, PAL or SECAM inputs – for example, from a video camera, VCR, DVD player, gaming device, etc. PAL and NTSC detection is automatic, SECAM must be selected in the 'Adjust sources' menu.

The DVI-D input accepts DVI digital connections (but on a DVI-I socket for added flexibility). An EDID signal is used to ensure that the PC or DVD player outputting the DVI signal knows the available range of resolutions in the unit.

To enable an input for HDMI usage, set the 'EDID to use' to [HDMI] in 'Adjust sources'. Once active, the DVI-U input will also accept audio via the HDMI link.

The table below shows how to select a particular input using the 'Adjust source' / 'Input type' menu:

Source	Connection	Input type setting
DVI-D	DVI-U	Auto / D-RGB
HDMI*	DVI-U	Auto / D-RGB / D-YUV
RGBHV / RGSB / RGsB	DVI-U	Auto / A-RGB
YPbPr / YUV	DVI-U	Auto / A-YUV
CV	DVI-U on 'Green'	Auto / A-CV
Y/C	DVI-U on 'Blue'/'Red'	A-YC

*For HDMI, also set 'EDID to use' in 'Adjust sources' to [HDMI]

Computer and Video outputs

The DVI-U outputs can be:

- Digital DVI-D or HDMI signals
- Analog Composite Video
- Analog Y/C (S-Video)
- Analog RGBHV (separate syncs at TTL levels)
- Analog RGsB (sync on green)
- Analog RGSB (separate sync at TTL levels)
- Analog YUV/YPbPr (including tri-level)

When the output resolution (as set in 'Output res') is set to PAL or NTSC, then the DVI-U connectors will output the Composite Video and Y/C signals. For all other resolutions, the output type is set in the 'Adjust outputs' menu.

HDMI output is automatically enabled based on the display connected to the unit.

SDI inputs and outputs

These are present on the C2-8210 and C2-8260 only and are SD/HD/3G compliant.

The input will auto-detect the particular standard in use. The LOOP output will then output a copy of that signal (re-clocked).

The SDI output is active whenever the 'Output res' in 'Adjust outputs' is set to an SD/HD or 3G-SDI compatible resolution. Typically these are PAL, NTSC, 720p, 1080i and 1080p resolutions.

Each SDI output is duplicated onto 2x BNC connectors.

GENLOCK input

The Genlock input supports Composite Video (PAL or NTSC), along with tri-level HD signals (i.e. 480p, 720p, 1080i and 1080p).

You can enable locking to this reference source using the LOCK button on the front of the unit. The LOOP output is a buffered copy of the GENLOCK input, and remains active when the system is in Standby mode.

Audio

Any audio embedded into an HDMI or SDI source can be routed to any output. This is done in the 'Adjust outputs' menu.

The Audio module present on the C2-8160 and C2-8260 can support 8x AES3-id inputs and outputs, as well as provide an audio delay facility.

Operating modes and architecture

The C2-8000 range has 3 main operating modes, which should be selected first depending on the application the product is used for:

Mode	Operation	Application
Switcher	Output 1 becomes a Program output, showing the transitions. Output 2 becomes a Preview output, showing the next source. Window A and logo 'a' support transitions including cross-dissolve. Window B is used internally by the unit. Window C is available for background or PIP usage.	Seamless switching
Independent	Outputs 1 and 2 are completely independent. Windows A and C, plus logo 'a' are available on Output 1. Window B and logo 'b' is available on Output 2.	Dual-channel Edge-blending
Multi PIP	Outputs 1 and 2 both show all 3 windows, plus logos 'a' and 'b'.	Multi-window

All modes also support LockandMix abilities, where the output is fixed to match a source on DVI-U1 or DVI-U2 and the image from that source is shown as a background.

The diagram below shows the full architecture of the unit. Different operating modes enable or disable certain routing within the unit.

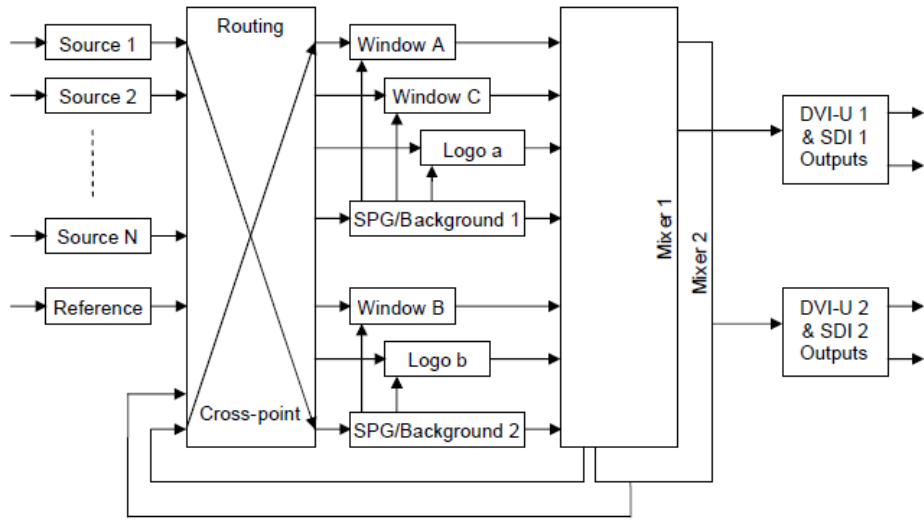

Switcher

In this mode Seamless Switching becomes possible with cross-dissolves and full preview of the next setup and source.

The user can change window source, size, position, logo, borders, etc. with a Preview of the setup, before pressing TAKE to then transition that setup to the Program output.

The following block diagram should help to explain the way that the unit works internally when in Switcher mode.

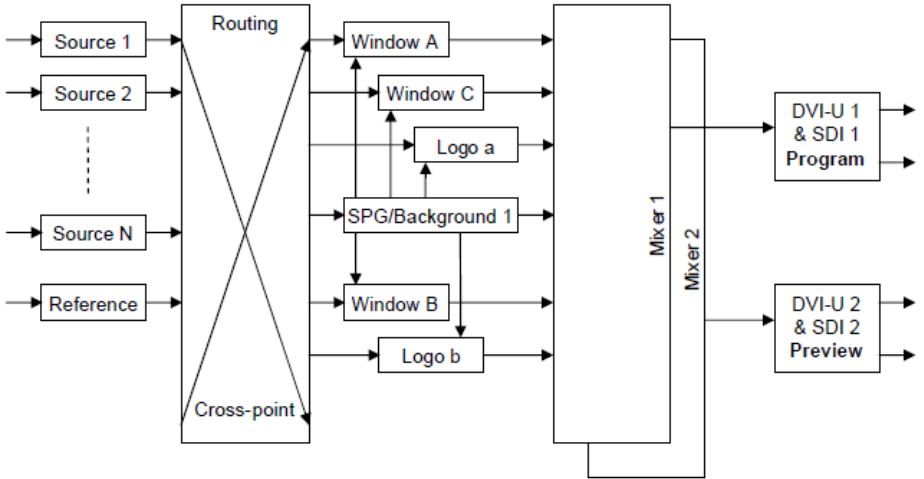

In the diagram above, the Preview output uses Window B (that is hidden from the user in the menu system) to show the next source and window size. On a transition, Window B is used to transition-in the new source before Window A shows it – thus allowing for a cross-dissolve to occur. Window C is shown on both outputs simultaneously.

Both outputs run at the same resolution.

Independent

In this mode, the unit's 2 outputs (DVI-U1 / SDI1 and DVI-U2 / SDI2) are completely independent of each other. The 3 scaling windows are split across the 2 outputs, with Output 1 having windows A and C, and Output 2 having window B.

Windows can be re-sized, positioned, have their source changed, etc. on one output without affecting the other output.

Edge-blending across two projectors becomes possible by using each scaled window to zoom into a different part of the same source. Window C on Output 1 can then be used as a PIP.

The following block diagram should help to explain the way that the unit works internally when in Independent mode.

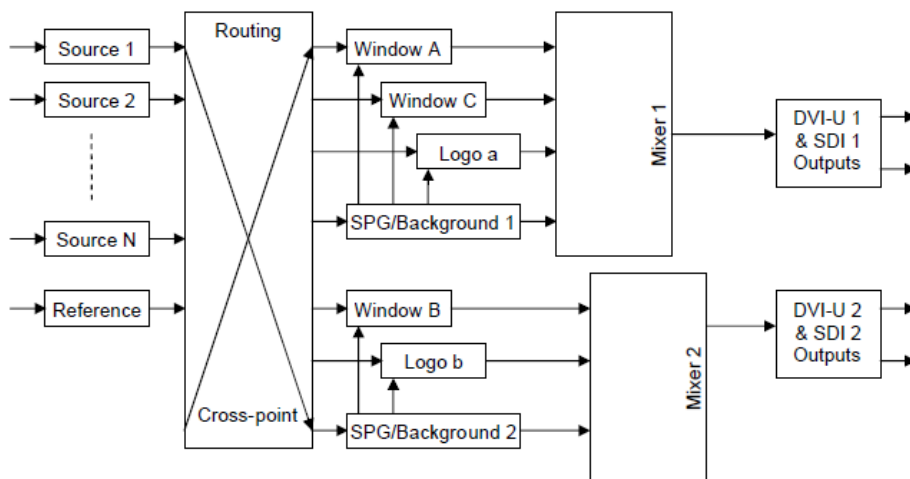

In the diagram above, the Windows are used for either Output 1 or 2, but never used on both. This allows the Sync Pulse Generators (SPGs) to run at different resolutions. Output 1 shows Windows A and C, whilst Output 2 shows Window B.

Multi-PIP

In this mode, both outputs share the same scaling windows and logo channels – although the keying and layering controls can be defined differently on both outputs.

With all 3 scaling windows present on both outputs, plus two logos, an optional LockandMix source and a background color, this mode gives 7 layers of video for the user to adjust.

The following block diagram should help to explain the way that the unit works internally when in Multi-PIP mode.

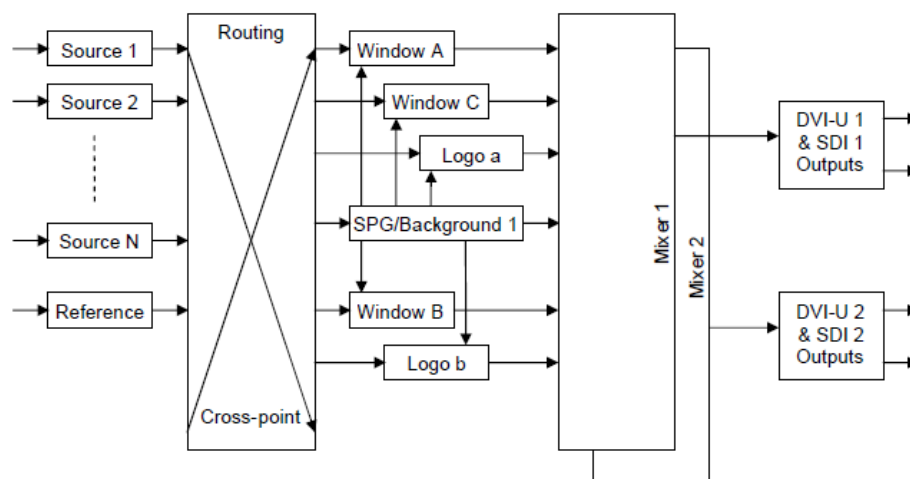

In the diagram above, all Windows are used for both Outputs 1 or 2, as both outputs are tied-together from the source sync source (and are thus always at the same resolution).

Menu layout and settings adjustment

From here on, we'll be looking at the menu structure employed and the individual menu items that allow you to take advantage of the power of the unit.

You'll be using the menu navigation buttons and the Liquid Crystal Display (LCD) to view the options and settings available to you. First press the left / right buttons to see where you are in the menu. Go into a sub menu by pressing the SELECT button once. To exit a sub-menu, scroll to the end of the sub-menu by pressing the right buttons to reveal Exit. Press SELECT to exit the sub menu.

You can also gain fast access to the start and end of a menu by clicking the up or down buttons.

You can edit a value in brackets '[]' by pressing the SELECT button once (you'll note that the brackets surrounding a particular parameter's value will begin to flash). Change the value by pressing left or right. Then finalize your adjustment by pressing the SELECT button once more.

A few menu items have multiple parameters within an individual menu selection. In those cases, you can adjust one item at a time. Change one value and then go left or right to the next.

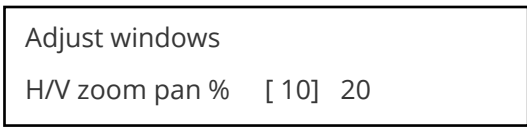

Or, you can use the up / down buttons to alter the value following the one in brackets. Therefore, in the example above, where "[10] 20" is displayed in a menu item, the one in brackets is adjusted using the left and right buttons, and the second number can be altered using the up and down buttons.

Holding the left, right, up or down buttons for a short time will keep adjusting the relevant value, therefore allowing fast changes to a setting – which is very useful for positioning something on screen.

Holding the SELECT button in for a few seconds stores all changes in memory. Unless you intentionally change it again later, the adjustment will remain even after power is removed from the unit.

Menus are arranged so that a particular general function has a menu name on the top line and beneath that either a sub-menu or one or more related individual settings are displayed.

In some cases the functionality is global – meaning it has an effect on the unit as a whole (such as changing the output resolution). In the majority of cases, the function is related to a specific operational area of the unit, detailed by the text in the top line.

There are two screens that appear before the Group Menus (sub-menus) are accessed.

The first is the 'welcome' display shown above indicating the model of the unit. The C2-8000 series comprises



of many different units and your particular model number will be showing in this menu.

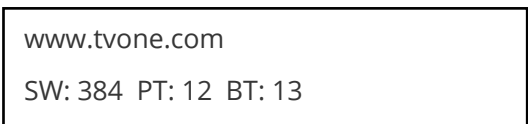

Moving to the next menu item displays the firmware information screen (the numbers on your unit will be different to those shown). The SW number refers to the version of firmware loaded into the unit, this can be upgraded from the support website.

The PT and BT numbers refer to Hardware version information and are of interest to the Technical Support Group should you ever need assistance.

At the end of all Group Menus will be an 'Exit' item. Simply select this to exit the existing menu structure and return to the previous one in the hierarchy.

Group names and descriptions

Menu Group Name	Group Description
Presets	Loads, Stores and Erases Presets
Adjust outputs	Controls output parameters and audio routing
Adjust windows	Controls characteristics of the windows
Adjust keyers	Controls the keying ability of the unit
Adjust logos	Controls the logo parameters
Adjust borders	Controls the borders for each window
Adjust sources	Controls signal source input parameters
Adjust transitions	Controls the method of transition when switching inputs
Adjust ethernet	Controls IP addresses and network parameters
Adjust resolutions	Controls unit's input/output resolution table
System	Controls global system parameters for the unit

Adjust presets menu item

Presets allow you to store up to 10 different setups of window size, position and keying controls. These are non-volatile and can be instantly recalled at a later time. They are only erased during a firmware update of the unit.

Presets only store and recall values in the Adjust outputs, Adjust windows, Adjust keyers, Adjust borders and Adjust logos menus (where your unit supports these). To store values present in the 'Adjust sources' menu, use the 'Push to Store' menu item found in 'System' or the special buttons on your unit.

Adjust preset
[1] Load Store Erase

Once you have set your unit up in the way you want it to be, simply select the Preset number you want to store the setup detail into, and select the 'Store' item.

At a later time, you can then recall the whole setup by again selecting the correct Preset number and clicking on the 'Load' item.

The 'Erase' item only erases the select Preset number – all other Presets are unaffected. Erasing a Preset returns all those settings to Factory Defaults.

Some units will have dedicated PRESET buttons, in which case:

1. Press and release to Load the Preset
2. Press and hold to Store the current settings to the Preset

Items associated with the adjust outputs group

This menu group allows adjustments to be made that specifically affect the output of the unit, including output resolution and locking/overlaying onto a computer or video source.

800 x 600 60Hz
Lock mode [Off] [RGB1]

This menu item allows the lock mode to be selected and the lock source to be defined. The top line of the display shows the current detected resolution of the selected lock source (RGB1 in this example). The lock mode can be either Off, Genlock or Lock and Mix, with the operation of these shown in the following table:

Lock mode	Description
Off	The output resolution of the Output is defined by the setting for Output Resolution and there will be no background source visible.
Genlock	The output video will be "Genlocked" to the selected lock source. The output signal will be synchronous to the input sync and adjustable but there will still be no lock source visible.
Lock and Mix	The output video will be locked to the selected source, the syncs will be locked (but with an additional internal video processing delay) and the background for the output will be that of the Lock source (unless foreground and background are swapped).
Frm.lock*	The frame rate of the output will be locked to the frame rate of the input. This can only work if the output resolution frame rate matches that of the lock source frame rate. 'Frm.lock' will flash until a highly stable lock has been achieved.

**Only certain models support this.*

In both Genlock and Lock and Mix modes the source selected for the lock input determines the resolution of the output image. The output resolution for the entire image can be no different than the resolution of the lock source. All synchronization signals are re-generated within the unit so they may look slightly different when compared on an oscilloscope to the original source.

In Frame-lock mode, the output resolution is independent of the lock source, but the frame-rate must match that of the source (e.g. 1280x1024 60Hz can be frame-locked to 640x480 60Hz). Frame-lock is very useful for synchronizing a HD-SDI output (e.g. 1080i 59.94Hz) to a composite video source (e.g. NTSC), or for scaling one resolution to another while avoiding any potential frame-rate conversion artifacts.

'H/V shift' can be used to align the output to the input more accurately, but this may cause instability until the lock is re-acquired ('Frm.lock' will flash).

Before turning the Lock feature on, you first must select a valid Lock source. Some units may not have all Lock sources available, depending on hardware limitations – see Specifications for details of limitations on your unit.

If the Lock source you choose is not valid, then Genlock or Lock and Mix will be temporarily disabled, until the Lock source becomes valid again. When disabled, the resolution previously specified in 'Output res' becomes the output resolution.

1024 x 768 60Hz
Output res. [28]

Your unit can handle a very wide array of inputs and convert them all to a single output signal with defined characteristics. This output resolution will remain in place until changed or it may be overridden by the lock mode and source.

The top line of the display will show the current output resolution selected. Some units will have a limited number of output resolutions depending on their function (e.g. Down Converters are more limited than Video Scalers).

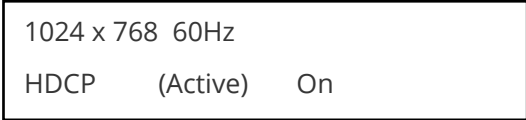

HDCP is handled only on certain units with DVI outputs, so this menu may not appear on your own unit. HDCP is a 'High-bandwidth Digital Content Protection' system, which can ensure that a high definition video signal cannot be received by units not equipped with a HDCP receiver.

This menu lets you see the current status of the output and whether HDCP is supported or active, and also lets you turn off the output's HDCP encryption system. Note, however, that turning HDCP off at the output will also prevent HDCP-encrypted signals from being received by the unit – see the table below.

By default, HDCP on the output is turned On - so that if your attached DVI display is HDCP-compliant, then your output will be encrypted (regardless of whether the input to the scaler is encrypted). Note that you don't have to attach a display to the output of the scaler – another unit can be connected instead, in which case that unit is known as a 'repeater'.

It is important to note that if your source is HDCP encrypted (for example, from a Blu-ray player) then you cannot output any un-encrypted signals that use this source (such as SDI, analog YPbPr, etc.). Only HDCP-encrypted DVI or HDMI can be output. Therefore if your source is encrypted then you must ensure that this HDCP setting is On and that your display is HDCP compatible.

Please also see the HDCP menu item in 'Adjust sources', as this controls availability of HDCP at the DVI input.

The status message given in brackets has the following meaning:

Status message	Description	Effect
No display	There is no display attached (HOTPLUG is low).	Nothing will be output on the DVI connector.
Unavailable	The device attached is not capable of supporting HDCP.	As the DVI output cannot be HDCP encrypted, then a HDCP-encrypted source cannot be selected for scaling.
Supported	The device attached is capable of HDCP, but the output is not currently encrypted.	As the DVI output is not HDCP encrypted, then a HDCP-encrypted source cannot be selected for scaling.
Active	The device attached is capable of HDCP, and the output from the unit is encrypted.	As the DVI output is HDCP encrypted, then a HDCP-encrypted source can be selected for scaling. Note that no other output connector (SDI, CV, YC, YUV or RGBHV) will function – since they are not encrypted.
Rep. supprt	The repeater unit (e.g. scaler) attached is capable of HDCP, but the output is not currently encrypted.	As the DVI output is not HDCP encrypted, then a HDCP-encrypted source cannot be selected for scaling.
Rep. active	The repeater unit (e.g. scaler) attached is capable of HDCP, and	As the DVI output is HDCP encrypted, then a HDCP-encrypted source can be selected for

Status message	Description	Effect
	the output from the unit is encrypted.	scaling. Note that no other output connector (SDI, CV, YC, YUV or RGBHV) will function – since they are not encrypted.

Adjust outputs
Output type [RGBHV]

Adjust outputs
Anlog= [RGBHV] Dig= RGBHV

This menu may appear as either of the above – depending on whether the analog and digital outputs are controlled separately.

This menu item allows you to select the type of signal output your unit will provide. Types of output vary depending on the resolution selected and include various types of component signals YUV or tYUV (tri-level YUV) and the full range of RGB type signals RGBHV, RGBS and RGsB (Sync on green).

Note that this value is remembered for each resolution – so you can set 1024x768 60Hz to RGBHV and 1280x720 60Hz to tYUV and both will be remembered separately. This value is not affected by a Factory reset – but is reset by a firmware update.

Adjust outputs
Optimize for SDI [On]

This menu item is only available on certain units with an SDI output and when locking to a CV or YC input. An internal de-jitter circuit ensures that the SDI output has a low jitter over the full 10Hz to 100kHz range, even though the CV or YC input may have a high jitter. However, this is not always compatible with a CV/YC output where the colour sub-carrier should not be de-jittered and needs to follow a Lock source’s input – hence it should be turned Off if the CV/YC outputs are going to be used.

Adjust outputs
Stand. [NTSC-M/PAL-BDGI]

This menu item is only available when the Output resolution is set to PAL or NTSC. With this you can change the output type to the PAL or NTSC standard with the further option of changing the output to the additional PAL and NTSC standards such as PAL-M or PAL-N. SECAM is also available as an output on some units, provided the ‘Output res’ is set to PAL / 50Hz.

Adjust outputs
Luma/chr BW [Med] / [Med]

This menu item is only available on certain units when the Output resolution is set to PAL or NTSC. With this you can change the output filtering system to increase or decrease the image sharpness. In general, high sharpness can result in increased colour disturbance.

Adjust outputs
Back Y/U/V [16] [128] [128]

Sets the value of the fixed background color, which is present when PIP is used with no Lock source background displayed. This menu item is only available for units with overlay, keying and fading abilities.

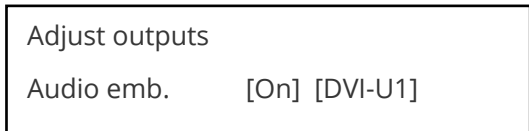

For certain units with HDMI and/or SDI-compatible inputs and outputs, the audio can be de-embedded from the video signal and sent to a compatible output.

'On' enables this to happen, and allows the audio source to be selected. 'WinA' sets the audio source to follow that of the main window's video source.

Items associated with the adjust windows group

This menu group allows adjustment to be made to window specific parameters such as the window source, its position, size and zoom level.

Window size adjustment can be performed in a number of different ways according to whether 'Aspect adjust' is set to Simple, Advanced or Pixel. The main part of this text assumes Simple mode – see later for a detailed description of the other modes.

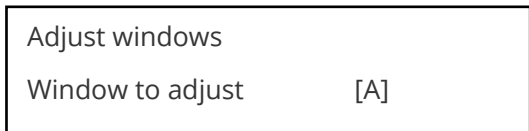

This menu item only appears on units with multiple windows or PIPs. It is used to select which one you want to modify. Alternatively, use one of the dedicated buttons on the front panel to choose the window to adjust.

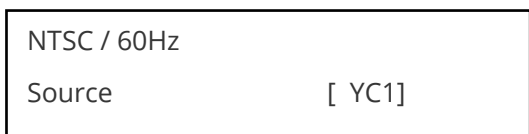

The source display screen allows the input source for the currently selected window to be changed. The top line of the display shows the detected characteristics of the signal. Valid Input sources match those available on the front of the unit.

Certain units do not have full flexibility of Window source and Lock source when Genlock or Lock and Mix are active (in the Adjust outputs menu group). See the Specifications for your unit to see if any limitations are present.

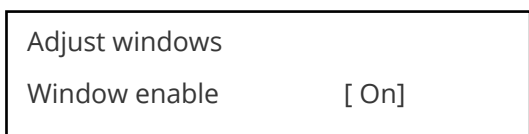

Available on certain units only, this quickly enables or disables the window being adjusted.

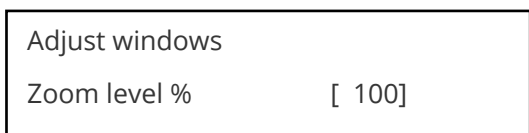

Changing this option, sets the amount of picture magnification you wish to use for the window Source. You are provided with the options to zoom the image from 100% to 1000% (10x zoom).

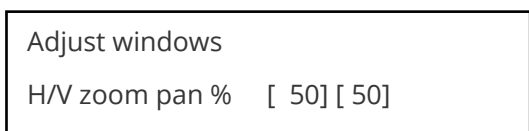

Once an image has been 'zoomed', this control allows the image to be positioned within the window so that any portion can be seen, not just the middle.

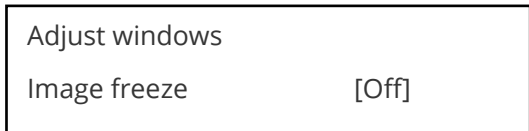

This menu item allows the image to be frozen or unfrozen – thus keeping a single image on screen indefinitely. Note that images are not stored when power is removed from the unit.

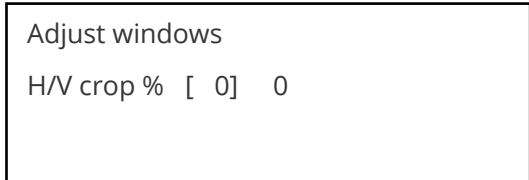

This allows the scaled image to be cropped at the top/bottom edges, or at the sides. Typically, this is used when performing a picture-in-picture (PIP) function (only available on certain models), where the incoming video signal has a letterbox or pillarbox size (i.e. it has black areas at the top/bottom or sides).

By adjusting the H/V values, you can crop out the black areas to correct the size on the final output screen. Note that it does not change the shape or aspect ratio of the image – but just removes the parts of the image that are not required.

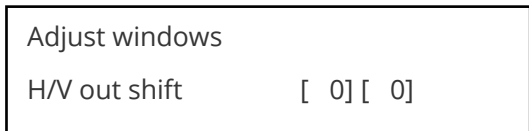

This positions the selected Window horizontally and vertically on the monitor. This should only be used for 'fine tuning' and should not normally require adjustment – use the Shrink H/V adjustment when your image is less than 100% Shrink value.



Shrink Level determines the percentage of the monitor's total available screen space that the selected Window image occupies. Adjustment is provided for a reduction down to 10% of the overall output size. In most cases, this feature is used for picture-in-picture (PIP) when a background image is being used (for units with overlay abilities).

Note that some units do not have the [On] entry – this is only for units with a PIP button on the front, with turns this entry On and Off. On these units, this feature is 'Off' by default, so that the full image size of 100% is used. Shrink level will need to be turned On before any change to this value has an effect.

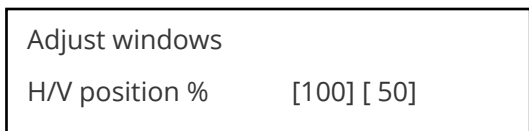

This menu option determines the position of the shrunken image on the monitor screen. This will move an image that is less than the full screen size left/right or up/down within the monitor's available screen space. It will not let you move the image off the screen, so certain values will appear to have no effect (unless you use a very low Shrink value like 10%).

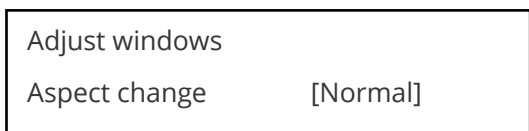

This item provides a simple way of changing the output screen aspect ratio, to suit the incoming video signal and final output display size. Use the zoom/shrink functions for occasions when the aspect ratio is an odd format.

Adjust windows	
Aspect adjust	[Simple]

See later section for further details on this item.

Adjust windows	
Temporal interp.	[Off]

This is a feature only present in advanced units only. It greatly improves the method of frame-rate conversion, by allowing the unit to merge frames together during the process.

When 'Off', the unit will use frame-repetition when converting 50Hz to 60Hz (i.e. it has to duplicate every 5th frame), or frame-dropping when converting 60Hz to 50Hz (i.e. it has to drop every 6th frame). When 'On', smooth blending is applied so that frames are not lost, but blended together at the appropriate times.

Adjust windows	
Flicker Reduction	[Low]

The Flicker Reduction menu item will only appear if you have selected a low resolution interlaced output such as PAL or NTSC. If you are using CV or YC outputs, this adjustment may be of interest, particularly when you have line drawings or similar fine detail. You can choose from four possible Flicker Reduction settings. You should use as little Flicker Reduction as possible because the Vertical detail will be softened at the highest setting.

Flicker mode	Function
Off	Disables flicker reduction (sharpest mode).
Low	Suitable for most input sources.
Med.	Enough for most situations such as thin line drawings
High	Highest amount of flicker reduction. Will cause loss of vertical detail in some images.

Adjust windows	
Image smoothing	[Auto]

Image smoothing reduces the jagged-edges sometimes seen within an output image by softening it. It typically improves the quality of a scaled image greatly. There are four possible settings for this adjustment: "Off", "Med.", "High", and "Auto". The "Auto" setting is generally thought to be most desirable and will vary the smoothing process according to the amount of zoom taking place.

Adjust windows	
Image flip	[Off]

Occasionally, it's necessary to cause the output image to be flipped Vertically, Horizontally or both – most commonly when a video projector is ceiling-mounted, or for special effects.

Adjust windows	
Show source label	[On]

Units that support source labeling have this menu item available, which allows the label to be turned on or off on a window-by-window basis.

Adjust windows	
Audio bars	[4]

Certain units can display audio bar measurements and this menu item displays how many stereo-bars are shown. A maximum of 4 stereo bars (8 bars in total, with left-right pairs next to each other) can be shown. Audio channels are always numbered from left to right, balanced to display bars on both sides of the each. A setting of 0 disables the audio bars from being shown.

Adjust windows	
Max fade level %	[100]

This Menu item fades the selected layer, and is only available on models with overlay abilities. Adjustment range is from solid to fully transparent.

Note: This menu item only appears on multi-channel scalars:

Adjust Windows	
Layer priority abABZ	[3]

This adjustment selects the order of the window layers. Layers are shown for 'a' and 'b' logo screens, Window 'A', Window 'B' and 'Z' is the Lock Source. The default condition is shown. The number shown is the current layer of the active window, when you adjust the layer number the layer stack indicator 'abABZ' will change to allow visualization of the layer stack. Note that layer 6 the Background Color is not shown as its layer position can not be altered – it will always be the background.

Extended scaling controls

The 'Aspect adjust' parameter is used to change the way that scaling of windows is controlled. By default it is set to 'Simple' which allows basic control of the window zoom and shrink sizes and positions – enough for simple tasks.

In 'Advanced' mode, it allows the horizontal (H) and vertical (V) components of the Zoom and Shrink functions to be adjusted independently, thus allowing custom aspect ratios to be created, or to convert from one aspect ratio to another.

In 'Pixel' mode, the user has direct access to pixel and line-accurate scaling functions. This lets the user specify the exact co-ordinates and size of the source image (within the video source), and the position and size of where this is placed in the output video signal.

The table below summarizes the different menu items in the different modes – the 'Simple' items have already been described earlier in this section, so only the 'Advanced' and 'Pixel' ones that are different (highlighted in bold) will be detailed here.

Simple	Advanced	Pixel
Zoom level % [100]	Zoom H/V [100]100 1.333:1	In [0],0 640,480
H/V zoom pan% [50] 50	H/V zoom pan% [50] 50	Out [0],0 640,480
H/V crop % [0] 0	H/V crop % [0] 0	
Shrink level % [50] Off	ShrnkH/V [50] 50 1.333:1	
H/V position % [50] 50	H/V position % [50] 50	

'Aspect adjust' = 'Advanced'

```
Adjust windows
H/V zoom % [100] [100]1.333:1
```

This item allows the independent setting of the horizontal and vertical zoom values. The third number (1.333 in the example) is the Aspect Ratio resulting from the adjustments, which is automatically calculated for you based on the incoming resolution and the H and V Zoom values.

Most resolutions are 4:3 ratio, thus the third number will be 1.333 (4 divided by 3). Another common aspect ratio is 16:9 (16 divided by 9 = 1.777). PAL and NTSC inputs are physically 4:3 on your video monitor, but their actual pixel/line ratios are different and so will not display as 1.333.

```
Adjust windows
Shrink H/V % [100] [100] 1.333
```

This item allows the setting of different Horizontal and Vertical 'shrink' sizes. The third number (1.333 in the example) is the Aspect Ratio resulting from the adjustments, which is automatically calculated for you based on the output resolution (the actual pixels and lines, not your physical screen size) and the H and V Shrink values.

Most resolutions are 4:3 ratio, thus the third number will be 1.333 (4 divided by 3). Another common aspect ratio is 16:9 (16 divided by 9 = 1.777). Therefore, to convert your 4:3 output into a 16:9 output, reduce the vertical (V) Shrink value to 75% and this will simulate a 16:9 output. PAL and NTSC inputs are physically 4:3 on your video monitor, but their actual pixel/line ratios are different and so will not display as 1.333.

'Aspect adjust' = 'Pixel'

```
Adjust windows
In [ 300], 150 750, 400
```

```
Adjust windows
Out [ 50], 50 250, 300
```

These menu items work together to specify the exact co-ordinates and size of the source image (within the video source) and the position and size of where this is placed in the output video signal - in other words the 'In' and 'Out' positions and sizes.

The diagram below should help to clarify the function of these values:

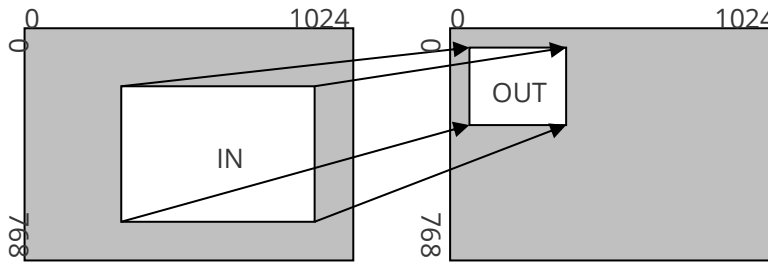

In the example above, 'In' has been set to 300,150 as its top-left source co-ordinate, with a size of 750,400. 'Out' has been set to 50,50 (i.e. close to the top left) with a size of 250,300.

The scaler will then ensure that the whole of the source (of size 750 by 400) is scaled to the required output (of size 250 x 300).

Items associated with the adjust keyers group

Please note that not all units have this sub-menu – it is only present on units with overlaying abilities.

Towards the end of this manual you will find a section titled 'COMMON OPERATIONS' – this gives a step-by-step guide to keying out a particular color.

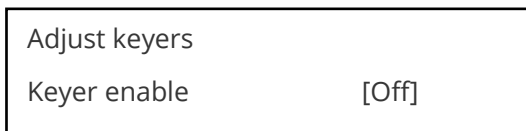

This menu item turns keying On or Off for the current foreground. A keyed image is in essence one image superimposed over another – such that portions of the top image are made transparent (keyed out), so that the background image can show through. The following settings allow you to vary the colour(s) that are keyed out.



This menu item is only present on single-channel scalers – dual and quad-channel scalers have the layer priority set within the 'Adjust Windows' menu.

This menu item allows you to swap the foreground and background images when Lock mode is set to Lock and Mix. It will have no effect in any other mode (since no background is present).

Normally, your foreground is the input (window) source and your background is the lock source. This then allows you to superimpose any graphics or video input on top of the lock source by keying out a certain color or range of colors in the input source. Swapping them means that the input source moves to the background and the lock source is now in front of it. Thus you are now keying out the lock source colors to reveal the input source behind it.

Note that this is different to simply swapping over the input and lock sources as that would affect the final output resolution – see examples below:

Input source	Lock source	Swap	Foreground (keyed)	Background (non-keyed)	Output resolution
XGA	NTSC	Off	XGA	NTSC	NTSC
XGA	NTSC	On	NTSC	XGA	NTSC
NTSC	XGA	Off	NTSC	XGA	XGA

Input source	Lock source	Swap	Foreground (keyed)	Background (non-keyed)	Output resolution
NTSC	XGA	On	XGA	NTSC	XGA

(XGA is 1024x768)

You will see that the Swap between foreground and background has no effect on the output resolution as this is always set by the Lock source.

Adjust keyers
Y Key min/max [0] [32]

The Min/Max parameters are used to select what range of Y (luminance/grey-scale) values are made transparent within the selected window/lock source. In order to key out part of an image, start with the max value and increase it until the required lighter parts within the window/lock source disappear. Then adjust the min level to bring back any darker parts of the image.

Adjust keyers
Y Key softness [0]

The Y Key softness option removes noise from the keyed image, generally at the edges. Adjust as required to make the edges of the key as sharp or as soft as desired. The noise is where the analog to digital process (A/D conversion) may not sample a 50% brightness as being exactly 50% i.e. sometimes 49% and sometimes 51%. Increasing the softness value will broaden the range of keyed colors so that the keying of images varies depending on how close a color is to the keyed-out range.

Adjust keyers
Y Key invert [Off]

The Y Key invert changes the keying characteristics with respect to what colors of the foreground image you wish to 'key out'.

Setting it to Off will cause the colour range that's defined to be removed - remove the desired colors. Setting it to On will cause the colour range that's defined to be kept - key out all other colors.

The descriptions above behave identically on the remaining U Key Invert and V Key Invert component versions. However they are directed at the U/B-Y (blue) colour component and V/R-Y (red) colour components respectively. Adjustment and effects are the same as explained above for Y Key Invert (brightness/grey-scale).

Edge blend items within the adjust keyers group

Please also see the section titled 'Edge blending setup' later in this manual.

Adjust keyers	
Edge blend	[None]

This menu item controls which of the 4 edges are blending into the background. In general, only the left or right are blending, but the unit allows you to control the edge blending for any number of edges.

If any edges are set (e.g. [L] for left) then Keying is no longer available and extra menu items will appear as follows:

Adjust keyers	
E.blnd guides	[Off]

This menu item allows you change whether the red and green edge blending guides will appear. You can have them permanently Off, permanently On, or set to Auto (where they will only appear when you are in the Adjust keyers menu).

Adjust keyers	
E.blnd size	[50] x [50]

This controls the blend width and height respectively. Left and Right blend sizes are adjusted together by the first number, and Top and Bottom blend sizes are adjusted together by the second number.

Adjust keyers	
E.blnd gam.	[1.00] x [1.00]

This controls the gamma for the blend width and height respectively. Left and Right blend gamma values are adjusted together by the first number, and Top and Bottom blend gamma values are adjusted together by the second number.

The gamma values affect the linearity of the blended edges, allowing for the fact that projectors do not normally output a picture whose brightness is directly proportional to the voltage within the video signal. These values are best adjusted once any overlapping images are aligned with each other.

Adjust keyers	
Eb comp cent/side	[0] [0]

This controls a 'compensation' value that sets the minimum brightness of the centre and side areas during edge-blending. It is used to compensate for the fact that projectors cannot generally output a purely black signal – and hence the overlap area would normally be brighter as a result. Increasing the centre area's value will compensate for this.

For 2x2 (or higher) setups, the side value can also be adjusted to correct for corner brightness errors

Items associated with the adjust logos group

Logos are like miniature Testcards, for 'labeling' of a video channel. Logos are loaded into the unit via the Windows based control utility and once in the device they can be called up for insertion as required. Horizontal and Vertical Position plus Fade Level are all controlled using this menu group.

Adjust logos	
Logo to adjust	[a]

Selects the Logo you wish to adjust.

Adjust logos	
Logo enable	[On]

Allows a logo to be turned off, and not displayed on the output screen.

Adjust logos	
Logo number	[1]

A fixed number of Logos can be stored in non-volatile memory for later recall. Use this setting to select the Logo to be displayed and adjusted.

Adjust logos	
H/V position %	[10] [10]

This parameter controls the position of the logo within the window as a percentage of the total size of the screen – thus [50] [50] would place the logo in the centre.

Adjust logos	
Max fade level %	[100]

This parameter controls how visible the Logo is to the viewer. A setting of 0 renders the Logo invisible whereas a setting of 100 makes the Logo fully visible. (In-between settings can give the Logo a transparent appearance.)

Adjust logos	
Layer priority abABZ	[1]

This adjustment selects the order of the window layers with respect to one another. In the above menu, 'a' and 'b' are logos, 'A' is window A, 'B' is Window B and 'Z' is the Lock Source. The default condition is shown, with Logos a and b in front of Windows A and B, which are in turn in front of the Lock source Z.

Items associated with the adjust borders group

The adjust borders menu allows the border function of your unit to be enabled – with one border being available for each Window, Logo and Lock source.

Note that the layer priority of the Border is the same as the Window source that it is 'attached' to.

Adjust borders	
Border to adjust	[A]

Select the window / logo / lock source you wish to adjust.

Adjust borders	
Border enable	[On]

Allows a border to be turned off and not displayed on the output screen.

Adjust borders	
Brdr size H/V	[8] x [8]

This adjustment allows the height and width of the border to be changed it can be up to 255 pixels thick.

Adjust borders	
Brdr offset H/V	[0] x [0]

This allows the border to be offset from the window. A typical application is the creation of a drop shadow effect. For example this can be achieved by setting the border size to 0 and then adjusting the H and V offset to 10 pixels.

Adjust borders	
Brdr Y/U/V	[16] [128] [128]

The color of the border can be changed to any color by adjusting the Y, U and V parameters. Y is the luminance, with U and V altering the blue and red content respectively. E.g. increase both U and V to give a purple colour, or decrease both to give a green colour.

Adjust borders	
Brdr opacity %	[100]

This parameter controls how visible the border is to the viewer. A setting of 0 renders the border invisible (transparent) whereas a setting of 100 makes the Logo fully visible. (In-between settings can give the Border a transparent appearance.)

Items associated with the adjust sources group

The 'Adjust Sources' menu group accesses the parameters associated with the processing amplifiers used for each input (RGB, CV, YC, etc.). They allow you to fine-tune an incoming signal to optimize its color, brightness or even sharpness.

Not all settings are available for all input types, and not all input types listed here may be available on your unit. Also note that many of these adjustments may not show without 'Advanced menus' set to On.

It is recommended that you Store your settings once you're happy with them in readiness for future use.

Source: RGB1	
Source to adj	[RGB1]

This menu item selects the input connection for which you want to make adjustments to. As in the image above, changes will only be made to the source connected to RGB1. Once the selection has been made, all changes made using the following operating parameters will only apply to the selected input.

Selection of a CV/YC source will reveal different menu items that allow adjustments beyond those used for RGB sources. The menu discussions that follow relate first to RGB sources, then to CV / YC type sources.

Menu items common to all inputs

Source: RGB1	
Aspect correct	[Fill]

This menu item will be used to correct the aspect ratio of the video source when converted into the final output resolution. The following table details what happens in the available modes:

Setting	Result
Fill (default)	The source is stretched to fill the output.
Aspect	The source's aspect ratio is maintained on the output.
H-fit	The source is stretched to fill the horizontal dimension of the output, with the vertical dimension stretched by the same amount (and possibly clipped).
V-fit	The source is stretched to fill the vertical dimension of the output, with the horizontal dimension stretched by the same amount (and possibly clipped).
1:1	Each source pixel is represented by a single output pixel – no scaling will be performed. If the input resolution is higher than the output, then only part of the source will be seen. If the input resolution is lower than the output, then a black border will be present.

Source: RGB1	
TL pos. adj.	[0] [0]

This menu item allows manual positioning of the Top and Left portion of the image. It is used to ensure that the input signal is captured correctly, eliminating any black borders. These settings are often used to correct the position of a PC signal on an input, or to eliminate any undesired noise at the top or bottom of a PAL or NTSC video source.

Source: RGB1
BR size adj. [0] [0]

This menu item allows manual positioning of the Bottom and Right portion of the image. These settings are often used to correct the position of a PC signal on an input, or to eliminate any undesired noise at the top or bottom of a PAL or NTSC video source.

Source: RGB1
Audio input source [1]

If your unit has an internal audio switcher / selector, this menu item selects the desired Audio input for use with the active video source, allowing an audio-follow-video function.

Source: RGB1
OPTION audio source [1]

If an external audio switcher is connected via the OPTION bus, then this menu item selects the desired Audio input for use with the active video source, allowing an audio-follow-video function.

In most situations, the Audio input values would be different for each video source – so that when the first video source is selected, so is the first audio source (this is called 'audio follow video'). The second video source then selects the second audio source, etc. However, there is nothing to prevent all Audio input values being set to the same value, for 'audio breakaway'.

Source: RGB1
Audio Vol [1] Bal [0]

This menu item adjusts the audio volume and balance for the selected audio channel. This is only functional for certain units when an optional Audio Switcher is attached.

Source: RGB1
On source loss [Blue]

(This has replaced 'De-glitch' used on previous firmware versions.)

This option is used to tell the unit what to do if the video source is lost or becomes unstable. Options are:

Option	Description
Show	Shows all picture break-up and instabilities.
Freeze	Freezes the latest frame – un-freezes as soon as the source becomes stable again.
Blue (default)	Turns the window blue, to represent source loss.
Black	Turns the window black.
Remove	Removes the window, thus showing any background (e.g. a Lock source). This is useful for MIX and PIP scenarios on units with overlay abilities.

If you have a very unstable input, such as a video tape player with a poor (jumping) output signal, you may wish to turn the setting to 'Show'.

Source : RGB1
De-int [M.comp med]

An interlaced input consists of two fields separated in time. Both fields are required in order to make up the full resolution input image, but since they are sent one after the other, a moving image will have “motion artifacts” if the two fields are simply combined together. The most common artifact is a blurring at the point of maximum movement within an image. Your unit provides some tools to minimize the effects of de-interlacing of an image.

The following options are available for this menu item:

Mode	Function
Normal/weave	The two interlaced fields are simply combined/weaved together. This will often show artifacts on moving images, but can be used when the input is known to be still.
Auto	Automatically selects Film 3:2 or Medium Range Motion Compensation (M. Comp Med.) depending on whether Film Mode is detected or not.
Film 3:2	Enables 3:2 pull down conversion of the incoming NTSC video. (This option should not be used if the source is not NTSC video).
M. Comp Low M. Comp Med. M. Comp High	Enables Pixel Adaptive Motion Compensation. Three levels are available with ‘Low’ providing the least compensation for Motion and ‘High’ providing the most compensation.
Frame/bob	The two fields are shown consecutively.

Source : RGB1
Diagonal interp. [Off]

This menu item allows the user to specify whether the source has diagonal interpolation applied to it when de-interlacing occurs. This reduces ‘jagged’ artifacts on moving images, however is not suitable for noisy sources where the noise could be mis-interpreted as a diagonal or sloping element of the picture.

Source : RGB1
Noise reduction [Off]

This menu item allows the user to specify whether the source has noise reduction applied to it. This is performed by averaging the video signal over a number of fields – but ignoring areas where motion has occurred. If motion blurring is seen, it is recommended to turn this setting off.

Dvi source menu items

Source: DVI1
HDCP [Inactive] [Off]

HDCP is supported on certain units only - and only on the DVI input connector. This menu item lets you change whether HDCP is active on this particular DVI input.

If turned ‘Off’, then a source that requires HDCP encryption will not send a video signal to your unit.

If turned 'On', and a HDCP-compliant display or device is attached to your unit's DVI output, then HDCP encrypted sources can be used.

The following table summarizes the message given in brackets:

Status message	Description	Effect
Inactive	HDCP is not active at the DVI connector.	HDCP-encrypted material cannot be received by the unit.
Active	HDCP is active at the DVI connector.	HDCP-encrypted material can be received by the unit, but only if a HDCP-compliant display or device is attached to the unit's output.

See 'Adjust outputs' for a description of how the HDCP system works on your scaler.

Source: DVI1	
Display emul. EDID	[DVI]

This feature is only present on certain units – it is used with the next menu item to form a simple 'EDID Manager'.

EDID is an information packet retrieved by a PC graphic card over a DVI link from a monitor which tells the graphic card which resolutions the display supports. In the case of your unit, it tells the graphic card what resolutions are compatible with it – by emulating a display.

The above menu lets the user select which of 8 EDID data blocks are 'shown' to a PC or other DVI/HDMI source. (It does not affect any other input.) Note that some graphic cards will usually only read the EDID data when the cable is first connected, or on power-up.

The 8 EDID blocks are as follows:

EDID	Usage
Mem1	User-definable – see 'EDID capture'
Mem2	
Mem3	
Mem4	
Mem5	
Mem6*	
HDMI*	Default HDMI EDID data for your unit
DVI	Default DVI EDID data for your unit
Mon	The attached monitor's EDID data

*Your unit will have either Mem6 or HDMI, but not both.

If you change this value, you'll need to store your settings and then re-boot the CORIO2 unit at least once to ensure that the source sees that the EDID data has changed.

It should also be noted that some graphic cards will require your PC to be re-booted before they see that a change has occurred.

If your unit allows 'HDMI' to be selected, this can also enable certain audio features depending on the abilities of your unit.

Source: DVI1
EDID capture [1] Grab

This menu provides a simple way of capturing EDID data from an attached DVI or HDMI monitor and storing it in one of the user-definable EDID memory data blocks (Mem1 to Mem6) – see previous menu.

To capture a different display's EDID, perform the following:

1. Connect that display to the DVI output of the CORIO2 unit - the CORIO2 unit will then read it automatically and store it in the 'Mon' EDID entry.
2. Select which EDID memory (Mem1 to Mem6) to copy this information to.
3. Select 'Grab' and click on it - this will copy the current monitor's information to that EDID memory.
4. Change 'EDID to use' to that memory location (Mem1 to Mem6).
5. Store your unit's settings (see earlier in this manual on how to do this).
6. Re-boot (turn off and on again) the CORIO2 unit to ensure that the graphic card uses this new EDID data (you may need to re-boot your computer as well).

Using the above, up to 6 custom EDID settings can be stored in the CORIO2 unit, ready for recall later. This is useful to simulate another display being attached to a graphic card.

RGB source menu items

Source: RGB1
Autoset status [Inactive]

Once the Autoset sense setting has been made, this menu item is accessed and activated. The Autoset sense utility will then correct the pixel phase and then position the Top Left portion of the image and the Bottom Right portion of the image. Once complete it then resume inactive status.

Source: RGB1
Input pixel phase [16]

Since an image pixel is a very small element of the total image, it's possible for your unit's Analog to Digital converters to wrongly sample the picture on the edge of each pixel thereby losing image resolution and creating image noise. The Input pixel phase adjustment allows you to change the position (from 0 to 31) where the pixels are sampled, relative to the horizontal sync signal.

To make this adjustment, select an RGB source and then provide an image from that source with fine detail, preferably with very sharp vertical lines. Adjust this value until you see the sharpest image. Alternately, adjust this value to give the worst (noisiest/softest) image, and then add or subtract 16 to get the optimum value.

Note that the AUTASET function (for RGB inputs only) will attempt to automatically work out the best value for this setting.

Source: RGB1
RGB input type [RGBHV]

There are several types of signals that are called RGB signals as a generic term. Each has slightly different characteristics that set it apart from similar RGB signals – such as how the synchronization signal is sent. This menu item lets you set the input type to use.

Available options let you select whether the input is standard RGB or YUV (including YPbPr signals with a tri-level sync). For some units, it also allows selection of break-out BNC connectors to be used instead of the normal connector (signified by B- in front of the signal type).

Source: RGB1
RGB contr. [100] [100] [100]

This menu item lets you adjust the individual RGB or YUV/YPbPr signals, in case one component is at a different contrast to other, or if they all need to be boosted or lowered.

CV and YC source menu items

Of the above Source Menu items, the Autoselect sense and Autoselect status functions, RGB type and Pixel phase are specific to RGB signals only. The rest of the Source menu items function with RGB, CV or YC type signals. In addition, there are four additional Menu items that are only used with CV or YC type signals and these are explained below:

Source: YC1
Bright [100] Contrast [100]

Adjust the Brightness and Contrast of the image to your requirement.

Source: YC1
Satur [100] Hue [0]

Saturation is the amount of color present in the image. Hue is the color "tint" parameter and the adjustment range is +90 degrees through to -90 degrees with 0 being the default.

Source: YC1
Sharpness [0]

Within limits, you can enhance or soften the appearance of detail within an image. The Sharpness values go both negative and positive, with 0 being the default. Note that over-enhancing an image has the side effect of making it appear to be noisy and under-enhancing an image gives the appearance of poor video quality.

Source: YC1
Luma delay [0]

On occasion, a video source will have the color portion of the signal offset from the luminance portion. If you've ever seen a poor quality comic book that has the outline of the cartoon character's head in one place on the page but the flesh tones for the head offset slightly, you are seeing the print equivalent of Luminance to Chrominance Phase Delay.

Fortunately, your unit provides a way for you to make the two signals occur at the same time on the selected image. The adjustment range provides both positive and negative levels of delay with 0 being the default.

Still image store and testcard source menu items

Source : TC1
Testcard [0]

This item is only available for units supporting Still Image Stores (SIS) or Testcards (TC) – which are the same thing, but may be named differently depending on your unit.

Used to select the image from memory to use as a source for the SIS / TC source currently selected. Dedicated software can be used to upload user-defined images – see our website.

Items associated with the adjust transitions group

Please note that not all units have this sub-menu – it is only available on some units with overlay and keying abilities.

Transitions control how your unit responds when a source is changed. Fades between sources, as well as wipes and cuts, are possible. The amount of time taken by a transition is controllable from instant transition (a 'cut') to several minutes.

Adjust transitions	
Transition	[Fade]

This first adjustment controls the type of transition desired: 'Cut', 'Fade', 'Wipe' or 'Push'.

If you select 'Cut' or 'Fade', the only remaining menu items will be 'Switching Fade Time' and 'Exit'. Selecting 'Wipe' or 'Push' exposes additional parameters.

Adjust transitions	
Switching fade time	[.5]

This parameter controls how long a transition from one input to another takes. The value can be 0 (a cut) or several minutes - adjustable in 1/10th second increments.

Adjust transitions	
Wipe type	[Left -> Right]

If you selected 'Wipe' or 'Push' for the transition type, then you will be able to specify the 'movement direction' of the transition that you want. Both 'Wipe' and 'Push' support: Left to Right, Right to Left, Up/Down (Top to Bottom), Down/Up (Bottom to Top). 'Wipe' also supports: Diagonal and Diamond effect.

Adjust transitions	
Wipe size	[100]

Items associated with the adjust ethernet group

(Please note that not all units have this sub-menu.)

Your unit can be remotely controlled via its RS-232 serial port, but some units can also be controlled via a Local Area Network using the Ethernet connector. This provides TCP/IP communications to and from the unit using a custom protocol.

In most networks, all computers and other electronic equipment will have a dedicated connection to a network hub or switch, with each item having its own 'IP address' (Internet Protocol address). This is the unique set of numbers that identifies the item on the network.

The network itself is usually segmented into a number of sub-networks. Small offices will generally just use one sub-network, with larger ones running many sub-networks that are linked together across a sub-network bridge. Sub-networks are split up by assigning different ranges of IP addresses to the different sub-networks. The ranges are defined by the 'sub-net mask'.

In very simple setups with 2 pieces of equipment (e.g. a computer and one other piece of equipment), it is possible to link the two together using just a cable (which must be a cross-over cable). However, this setup is rare.

Where only a single sub-network exists (as in the majority of cases) it is vital that:

1. All equipment has different IP addresses.
2. All IP addresses are part of the same sub-net.
3. All equipment has the same sub-net mask.

In most situations the computer will already be attached to a network, and therefore its IP address and sub-net mask will be easily accessible (e.g. in Windows XP you can right-click on the network activity icon to see the Support status, or check the Network Connections in the Control Panel and right-click the 'Local Area Connection').

An IP Address then needs to be assigned to your unit. Typically this will be by changing the last of the 4 values (that are separated by dots) to one that is not yet in use. The 'IP add' menu item is used to enter this into your unit.

The sub-network's 'sub-net mask' then needs to be copied to the 'IP sub' menu item listed below.

For simple setups (where only a single sub-network is in use), there is no need to change the IP gtwy (gateway) numbers.

Adjust ethernet	
IP enabled	[Auto]

This parameter has three possible states: On, Off and Auto. On and off manually control the Ethernet capability of the unit. When in Auto mode, if a valid Ethernet connection is present, remote control of the unit will automatically default to Ethernet and control via RS-232 is disabled whilst that connection is maintained.

Adjust ethernet			
IP add.	[10]	1	2 123

Enter 4 numbers one by one to form the IP address you wish to assign to the unit. The IP address is a series of four numbers between 0 and 255. Anything above 255 is not a valid number in an IP address range. The unit will not allow you to go above 255.

The IP address must be a unique address on your network, and also must be within the sub-net of your network. If you are unsure about which IP address to use or don't have a unique IP address, ask your Network Administrator.

Adjust ethernet	
IP sub.	255.255. [255.000]

Adjust the last 2 numbers to set the sub-net address (also know as sub-net mask) of your network. Again, if in doubt ask your Network Administrator.

Adjust ethernet			
IP gtwy.	[10]	1	2 123

Enter your network's gateway IP address into this menu item. Again, if in doubt ask your Network Administrator. In general, the gateway only needs setting if the unit is being controlled from a different network (e.g. via the internet).

Adjust ethernet	
IP port	[10001]

Enter the IP port number you wish the unit to communicate on. Keep a note of this as it will be needed when using other devices to communicate with the unit e.g. CC-300.

1A Adjust Ethernet	
Set new IP data and reboot	

Certain units require a re-boot once the new IP address has been entered. Once activated, all current settings (including other menu items) will be saved and the unit will re-boot. If you do not see this menu item, then your unit has already implemented your changes and no re-boot is required.

Items associated with the adjust resolutions group

The Adjust Resolutions Menu Group only appears when the Advanced Menus function is turned on within the System Menu Group. To turn it on, go to the System Menu Group and then proceed to the item that says "Advanced Menus". Turn the function 'On', exit the Systems menu and return to this menu structure.

The Resolution Database is used by your unit to identify any incoming video signal and is also used to create an output resolution. It is therefore a very important part of the unit's infrastructure.

Important cautionary information

Do not adjust these items unless you're certain you know what you're doing! The only method to undo certain changes is to update the firmware.

Try using the autoset, shrink, shrink pos, tl and br adjustments first.

Making adjustments here risks creating a non-standard resolution that is not displayable on a monitor. The resolutions and values within the database are industry standards and should not normally be altered by the user. That said, there might be times when it is necessary to create a custom resolution with specific parameters. If circumstances require you to make such a change, please read the following specific notes:

1. Any changes made to this database take effect instantly and are also stored immediately in non-volatile memory.
2. Since this database is used for both input and output image processing, altering a resolution that is used for both (e.g. 1024x768 input and 1024x768 output) may give undesired effects.

800 x 600 60 Hz	
Image to adjust	[17]

Change the value to select resolution you want to alter.

Typically, the image number currently being used for input or output would be already be selected otherwise immediate feedback to your changes will not be available via your monitor.

800 x 600 60 Hz	
Interlaced	[Off]

This adjustment specifies whether the image is interlaced or progressive scan. It toggles simply On or Off, so there are no flashing brackets.

800 x 600 60 Hz
H.freq.crse [37.879] kHz

Course Frequency Adjust

The H freq.crse (Horizontal Sync Frequency - Course) adjustment provides the option for changing the Horizontal Sync timing Frequency in 100 Hz steps.

800 x 600 60 Hz
H.freq.fine [37.879] kHz

Fine Frequency Adjust

The H.freq.fine (Horizontal Sync Frequency) adjustment provides the option for changing the Horizontal Sync timing Frequency in 1 Hz steps. Use this option to fine tune after using the course adjust.

Please note that the internal sync generator may be unable to generate the exact frequency you want.

800 x 600 60 Hz
Clks/l [1056] = 40.000MHz

This option changes the total number of image pixels on one line of monitor video including the Horizontal sync pulse and blanking time. This is normally in a multiple of 8. It is very important to get this value correct, or many digital display devices, such as TFT monitors, will display an image with an odd moiré effect – such as soft vertical bands spread evenly across the image.

800 x 600 60 Hz
Lines/f [628] = 60.317 Hz

This menu controls the total number of lines of video present in the image which includes the vertical Sync pulse, the blanking period and the active video. Changing this option affects the final vertical sync frequency.

800 x 600 60 Hz
H/V active [800] x 600

A video frame includes both the active area, the portion of the image normally containing useful visual information, and a resolution value for a given display standard which only expresses the number of pixels visible in an image.

The well-known 800 x 600 computer resolution standard simply means that there are 800 pixels/line visible horizontally and there are 600 lines visible vertically.

This item provides a way to change the number of active pixels and lines.

800 x 600 60 Hz
H/V Start [88] x 23

There is a period of time between the end of the Horizontal Sync pulse and the start of Active Video. This portion of the waveform signal is called the “Back Porch”, a term originating with the television broadcasting industry and its RS-170A specification. In practice, this will control where the video image starts on the left side of the monitor without changing the width of the sync pulse itself (another way to control where the

image area starts). The two parameters control where the back porch is positioned and they interact to a degree.

By adjusting these parameters, you control the start of the back porch (with respect to the trailing edge of Horizontal Sync) and also its width. The place where the Back Porch begins with respect to the Horizontal Sync pulse and the width of the Back Porch have a direct bearing on where the active (visible) portion of the image begins. Do not attempt this adjustment without monitoring the results with an oscilloscope.

800 x 600 60 Hz
H/V Sync [128] x 4

There are standards for all current computer and broadcast resolutions that specify the correct width of both Vertical and Horizontal synchronizing pulses.

If you are creating a special, non-standard resolution, you may wish to adjust the pulse width to fit your new requirements. The H/V Sync screen is where that is accomplished.

Like the H/V Start adjustment, you must use an oscilloscope when making these adjustments so that you know exactly how many milliseconds or microseconds of pulse width you have created. The numbers shown are relative numbers and not an actual time measurement.

800 x 600 60 Hz
Sync polarity [+H+V]

Sync can be either negative polarity or positive polarity. To further complicate things, it is possible that you may want to make the Horizontal Sync polarity different from the Vertical Polarity. This control allows you to make that change. You have four possible selections:

- +H+V
- H+V
- +H-V
- H-V

Items associated with the system group

The final Sub Menu is for adjustments of System parameters. The "System" in this case means the unit's functions that are generally unrelated to individual inputs, outputs or any of the various production features.

System
SW: 16, PT: 12, BT: 13

This screen is an informational screen. Should you require technical assistance with your unit, the technical support personnel may request that you read the contents of this screen to them during the support call.

The first section, "SW", is the version of the software that is installed on your unit. You can update software via the User Support web site (procedure to be described later in this manual) and the updates are currently free of charge. "PT" refers to Product Type and "BT" means Board Type. Both of these are hardware designators and cannot be changed by the user however both designators are important to support personnel.

System	
SW date:	2006-7-11

This is an information page showing when the currently installed software was released. The information is useful to the user as he or she compares the date to the website information describing the current software release.

Normally, the user will examine the added features of each new software release and determine if an update is worth doing in their particular operation. The greater period of time between the current date, and the date shown for the currently installed software, the greater the likelihood that there are useful changes and improvements present in the new release.

System	
TAC#	27-AA-1C-93-F8-33

The TAC number is a unique identifier for the unit and is for use with the PPF value below.

System	
PPF#	1A-67-2B-9D-50-4F

The PPF number is for units that support the 'Pay Per Feature' system. Extra features in the unit (such as Mix and Key) may be activated using this menu item by entering in the correct numbers and re-starting the unit.

System	
Push to store	

This screen provides a quick and easy way to store all current operating parameters. The unit will remember the set up you are currently using at the time of data storage and also when you next apply power. To store the current settings, press and release the control button.

System	
Autoset sense	[Medium]

In order for Autoset to work properly, it needs a sufficiently bright full-screen image to examine. The sense level lets you change the brightness threshold for detection of the screen edge between Low, Medium, High and V.high. Medium is the default level, which is recommended for normal use (Windows-type images, etc.)

System	
OSD on power up	[On]

This parameter controls whether the 'welcome' screen is displayed or not on power up for units with an on-screen display – it can be disabled as required. This is useful when a unit is installed as part of an overall system.

System	
LED brightness %	[90]

This parameter is available on certain units and controls how bright the LEDs on the front panel appear.

System	
LCD backlight	[On]

This parameter is available on certain units and allows the LCD backlight to be turned on and off.

System	
LCD contrast	[200]

This parameter is available on certain units and allows the LCD contrast (viewing angle) to be altered.

System	
LED brightness %	[90]

This parameter is available on certain units and controls how bright the LEDs on the front panel appear.

System	
Serial type	[RS-232]

This menu item controls the type of serial port in use on certain units (not all units support this feature). Options available are RS-232, RS-422 and RS-485. The default is RS-232.

System	
RS232 baud rate	[57600]

This menu item allows the adjustment of the serial baud rate used for RS-232 communications. The rate can be adjusted to 9600, 19200, 28800, 33600, 38800, 57600 and 115200. (This adjustment is provided for those instances where you wish to use the RS-232 control system for your own purposes.) The default baud rate is 57600.

System	
Buzzer	[On]

The screen labeled 'Buzzer' is actually the control for turning the "Beep" "On" or "Off". Normally this is left in the "On" position to provide positive feedback that your data entries and parameter changes have been accepted.

System	
CC-300 A/B bus mode	[Off]

This menu item changes the function of an attached CC-300 CORIO console unit. When set to 'On' any 'Take' will result in the A and B windows ('buses') being swapped at the end of the Take – so that another 'Take' will put them back to as they were before. (Note that not all units support the CC-300.)

System	
Resolutions	88

This screen is an informational screen showing the total number of the defined resolutions in the resolution database. Future firmware releases may increase the total number of resolutions defined in the database.

System	
Logos / T-cards	1 / 4

If your units supports Logos or Still Images / Testcards then this screen will display how many are present in the memory of the units.

Power Cycles refers to how many times the unit has been powered since it left the factory. This is an informational screen. No action is taken regardless of the value shown here, however some users have an equipment cleaning or specification audit procedure and this information may be useful to those users.

System	
Firmware updates	11

Indicates the total number of times the firmware has been changed over the life of the unit. It is quite possible for this to be more than 1, as a unit undergoes numerous tests during production.

System	
Hours in Use	877

This is another informational display for usage audit purposes.

System	
Temp.C	30 33 43 45

Certain units have built-in temperature sensors, and if yours has such a feature then the above menu item will appear. If the ambient temperature of the internal components becomes excessively high or low, the unit will shut down to prevent harm. This display shows the current value of the ambient temperature at four locations within the case and can be an early predictor of a shutdown before the shutdown actually occurs.

Should you experience problems with your unit, Technical Support may request that you give details of these values.

System	
Fan speed (rpm)	6000

Certain units have built-in fans to keep the unit cool. The fan speed is monitored and if it deviates from normal parameters too much, this will be taken as an indication of insufficient airflow over critical components and shutdown action will be taken.

Edge-blending setup

Introduction

Edge-blending is a method whereby two or more video/data projectors are used together with part of their images overlapping, thereby creating a wider (or taller) display more suitable for showing wide-screen video images. The term edge-blending relates to the fact that the overlap needs to be carefully handled to prevent the overlap causing image brightness problems.

This guide is intended to summarise how to setup such projectors when used with a suitable number of TV One's CORIO®2 scaling engines. The C2-7000 and C2-8000 series are dual processors and therefore require only a single unit to perform both tasks, whereas other units will generally require two units to be used together, with a distribution amplifier on the input so that both units receive an identical video source.

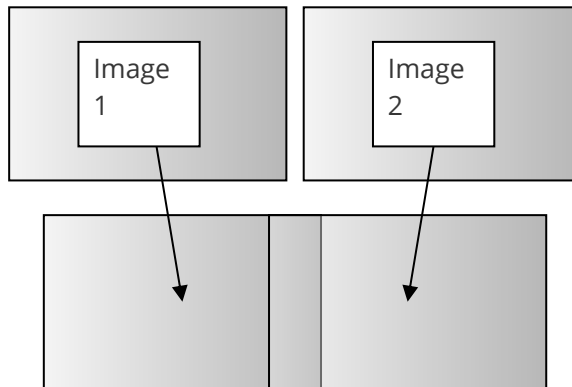

Basic method of overlapping two projection images to create a

Because the two overlapping areas will create a brighter than normal image, 'blending' is performed on the edges to allow seamless merging of the images together. The 'blend' is basically an S-shaped curve that is applied to gradually reduce the brightness of the image at the edge, so that they can overlap properly:

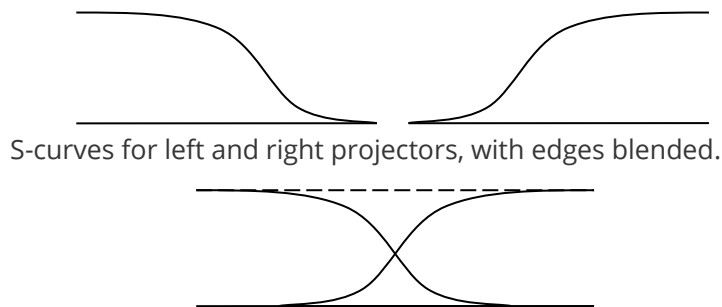

S-curves, when properly overlapping, will add together to result in full brightness.

Edge-blending requirements

To obtain the best edge-blending results, you will need:

1. A perfectly flat projection screen. This is vital, or it will not be possible to perfectly align your two projected images with each other.
2. Two matched projectors. Every projector on the market is different, with different lenses, projection methods, brightness, contrast, etc. Ideally you will need to identical projectors to obtain the best results.

3. A solid table or mounting bracket. Once you've set up your projectors and aligned them, you will not want them to move – so some method of holding them in place with brackets secured to walls or ceilings, or simply a sturdy table, will be vital.
4. Adjustable mountings (or more preferably projectors with built-in advanced adjustments). Proper alignment of two projectors can be very difficult, but will be aided by using some sort of mounting bracket that is easily adjustable. You may need to be able to move the projectors independently in all directions: left, right, up, down, forward, backward and also be able to tilt them to correct for any rotational errors.
5. Adjustable projectors. Most projectors will offer certain advanced features such as key-stone correction. This will be vital to ensure proper alignment, as it will partly compensate for mounting problems.
6. Of course, you'll need one or more CORIO®2 units (depending on the model) with the latest firmware that supports edge-blending.

Basic setup of the two projectors

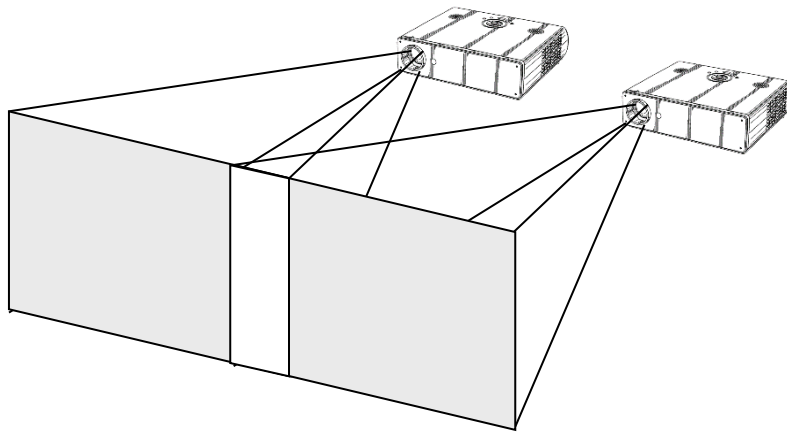

Basic video projector setup showing overlap.

The above diagram shows how the two projects should be placed to create a wider than normal image. The amount by which they overlap is very important, as this will also relate to the zooming values to be used for each of the CORIO®2 scaling engines.

Zooming is required because each projector is showing slightly more than half of the projected image, and thus each channel needs to be zoomed into a different area of the original source picture.

At this point, it is only necessary to place the projector roughly where you would like them to be, with around 15% overlap horizontally. If your projectors are already fixed into position, check that there is around 10% to 20% overlap, or edge-blending will not be possible.

You must also ensure that both projects are in focus with the same zoom settings (if your projector has this). It is often worth doing a 'factory reset' on them to ensure that no other settings (such as gamma correction or tilt) are active.

Connections to the scaler(s) and projectors

For CORIO®2 units with two scaling engines (such as the C2-7000 and C2-8000 series), use outputs 1 and 2 to connect to the left and right projectors respectively.

If two single-channel scalers (such as the C2-1000 or C2-2000 series) are used, then connector unit '1' to the left-most projector, and unit '2' to your right-most projector. Hereafter, we'll talk about Output 1 and Output 2 as referring to unit 1's output and unit 2's output.

For use with dual-channel, connect your video source (e.g. a DVD player or computer) to an input on the unit. It is not necessary to feed two signals – the unit can use the same signal for both outputs.

For 2 single-channel scalers, you can either use a distribution amplifier so that a single video source is split into 2 signals, or use the 'loop' output available on some units.

Initial setup

This section describes how to start setting your scaler up. It is vital that your scaler is 'clean' of any user settings, so it is advisable to perform a full factory reset by either re-updating the firmware, or doing a factory reset (see earlier in manual for how to do this).

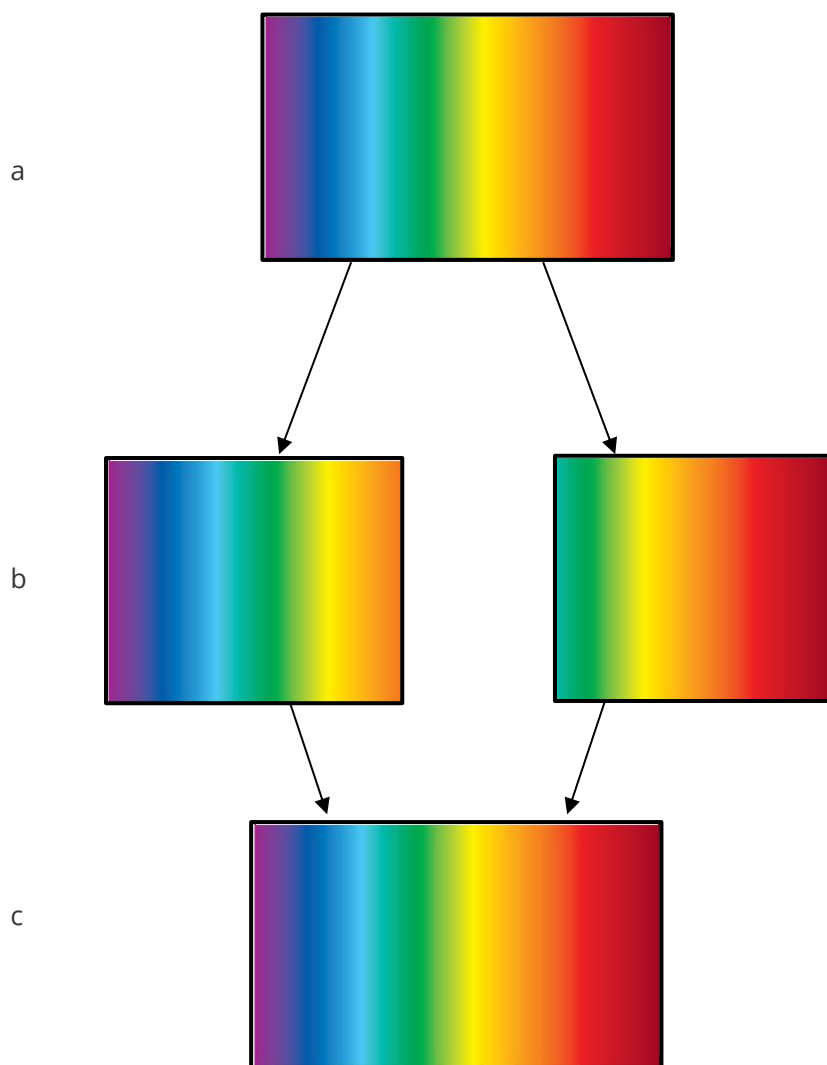

Showing setup of zoom for each channel.

Figures 'a', 'b' and 'c' show how an original wide-screen image is 'split' into two using identical zoom values on Output 1 and Output 2. Zoom values for around 10% to 20% overlap are usually around 180%. In other words, not quite 2x zooming (since that would give no overlap at all).

Figure 'a' shows the original image and 'b' shows the two zoomed images. Note that the two images are at different 'Pan' positions – i.e. they are zoomed into different areas of the image – the left and right-hand sides. Figure 'c' then shows the images re-combined as they should eventually appear on your projection screen.

To produce the above effect, you'll now need to change some settings on the units:

1. On a dual-channel unit, set the unit into 'Independent' mode – this runs both scaling engines independently as 1A and 2B.
2. Go into the 'Adjust outputs' menu and ensure that both scaling engines are outputting the same resolutions. (Hint: use Toggle 1 / 2 (Shift-1) to switch between 1A and 2B on the C2-7000 series.)
3. Go into the 'Adjust windows' menu and ensure that both scalers are set to the same 'Source', which needs to be your original video signal (e.g. from a DVD player).
4. For Output 1 (1A), change the 'Zoom' value to 190%, with H pan% of 0% (fully left).
5. For Output 2 (2B), change the 'Zoom' value to 190%, with H pan% of 100% (fully right).

If your projectors are properly setup and connected, with the scaler active with the above settings, you should now have a very rough overlap of the two images on a single projection screen. Where they do overlap you will see an over-bright part of the image, and most probably some overlapping errors.

Edge-blending activation

Edge blending is activated in the 'Adjust keyers' part of the menu, as follows:

1. Go into the 'Adjust keyers' menu.
2. For Output 1 (1A), change 'Edge blend' from 'None' to 'R' – so that it's right-hand edge is blended.
3. For Output 2 (2B), change 'Edge blend' from 'None' to 'L' – so that it's left-hand edge is blended.

You will also notice that some red and green lines have appeared. The red lines indicate the edge of the screen, and the green lines indicate the start or end of the blend. If these lines are not present, change 'E.blend guides' to 'Auto' or 'On'. 'Auto' makes them appear only whilst you are in the 'Adjust keyers' menu. 'On' forces them to be on all the time.

Edge-blending overlap / size

The blend size needs to be the same on both keyers, and is related to both the output resolution ('Output res' in 'Adjust outputs') and the zoom value ('Zoom' in 'Adjust windows').

There is a formula for calculating the edge blend size (E) from the zoom value (Z) and horizontal pixel width of the output (H):

$$E = 2 * H * (1 - Z/200) \text{ [pixels]}$$

For example, with zoom (Z) at 190%, output resolution of 1024x768 (H=1024), we can calculate E as:

$$E = 2 * 1024 * (1 - 190/200) = 102.4 \text{ [pixels]}$$

There is also a formula for calculating the zoom value (Z) from the edge blend size (E) and horizontal pixel width of the output (H):

$$Z = (1 - E / (2 * H)) * 200$$

For example, with E at 150 pixels, an output resolution of 1920 x 1080i (H=1920), we can calculate Z as:

$$Z = (1 - 150 / (2 * 1920)) * 200 = 192 \text{ [%]}$$

For the recommended zoom value of 190%, the following edge blend horizontal sizes should be used for various output resolutions:

Zoom %	Output resolution	Edge blend H size
190	640 x 480	64
190	800 x 600	80
190	1024 x 768	102
190	1280 x 720	128
190	1280 x 1024	128

190	1600 x 1200	160
190	1920 x 1080i	192

To set these edge-blend widths, perform the following:

1. Go into the 'Adjust keyers' menu.
2. For Output 1 (1A), change 'E.blnd size' (the first number) to the H size recommended above.
3. For Output 2 (2B), change 'E.blnd size' (the first number) to the H size recommended above.

It is very important for Outputs 1 and 2 to use the same blend width, or you will not be able to accurately blend your images. However, should your projectors be mismatched, changing the blend width on one or both of them can sometimes help – but this should be done as a last resort.

Edge-blending guide lines

These lines, as mentioned earlier, are used to aid the alignment of your projectors. They show the area to overlap – the red lines indicate the inside edge of the output resolution, whilst the green lines indicate the edge of blending. (G marks the green lines, R marks the red, Y marks the yellow, for those reading in black and white.)

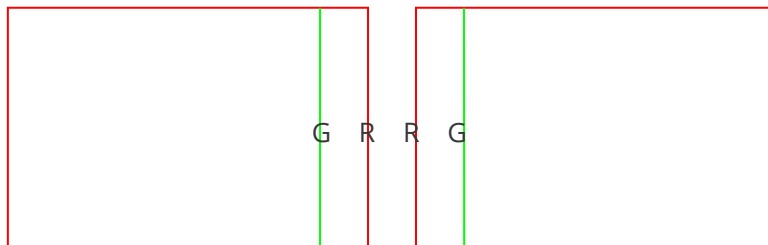

Outputs 1 and 2 with guide lines shown.

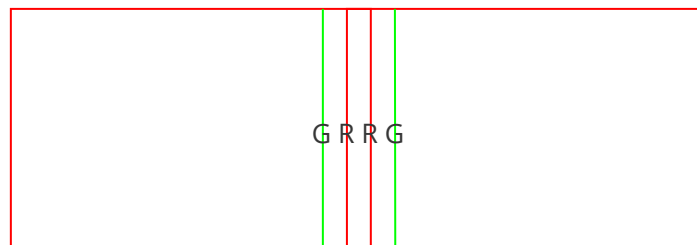

Outputs 1A and 2B partly overlapping.

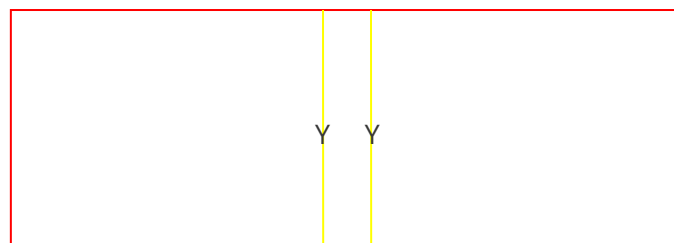

Outputs 1A and 2B perfectly overlapping – the red and green lines turn to yellow when aligned together.

Alignment of projectors

This is possibly the most difficult part of properly setting up edge blending. Using the guide lines, you need to fine-tune your projector positions and tilts so that the above-mentioned red and green vertical lines perfectly overlap to produce yellow ones.

Depending on how your projectors are aligned, you'll get different results, each with different solutions as detailed below:

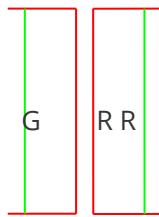
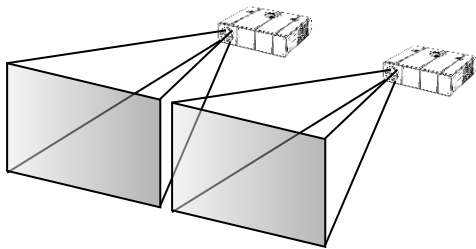

Too far apart
– you need
around 15%
overlap, such
that the red
and green
lines overlap.

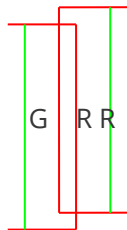
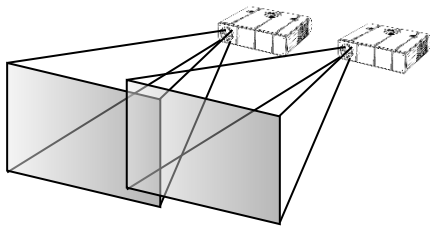

Offset – make
sure your
projectors are
perfectly aligned
both horizontally
and vertically.

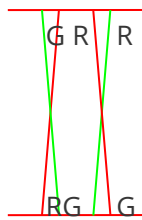
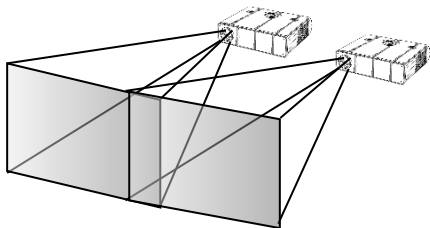

Key-stoning –
ensure your
projectors have the
same keystone
values, to produce
perfectly aligned
vertical lines.

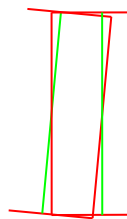
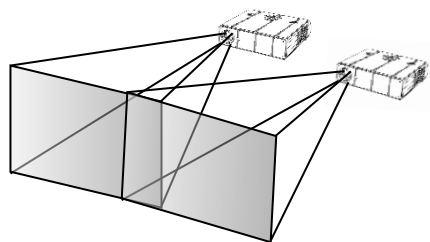

Rotation – one or
both of the
projectors has a
slight tilt. Once
corrected, you
may then need to
re-align them.

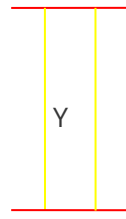
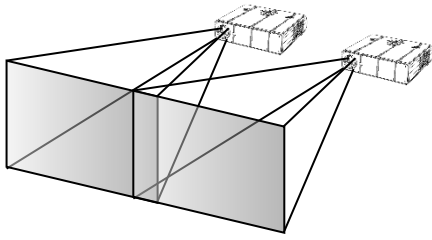

Perfect alignment
– your red and
green vertical
lines should
overlap to
produce yellow
ones.

Gamma correction

By now you should have two perfectly aligned projectors, but possibly with a brighter than normal overlap. This is most probably because a projector's luminance is not perfectly linear and therefore will need to have what's called 'gamma correction' applied.

Gamma correction is available within the same 'Adjust keyers' menu as the other adjustments. You will need to adjust both output channels gamma correction to be the same, unless you have non-matching projectors.

To change gamma correction:

1. Go into the 'Adjust keyers' menu.
2. For Output 1 (1A), change 'E.blnd gamma' (the first number) until the brighter area starts to dim – note the number required for this.
3. For Output 2 (2B), change 'E.blnd gamma' (the first number) to the same gamma value as per above.
4. Repeat steps 2 and 3, changing up or down as necessary until the bright patch has disappeared.

The 2nd number in the 'E.blnd gamma' is for where you have projectors stacked vertically – e.g. for a 2x2 edge blend arrangement. The 1st number adjust the horizontal blend's gamma value, whereas the 2nd controls the vertical blend's gamma value.

Note that it may not be possible to completely remove a bright patch – this is because some projectors can not actually output completely black images, with some light always leaking through. However, the next adjustment is designed specifically for this.

Brightness compensation

If you find it impossible to completely remove the centre overlap for all images (i.e. dark images and bright images being projected), then two extra compensation adjustments are provided to help with this.

The compensation is needed because most projectors cannot output pure black – there's always some light 'leaking' to the projection screen. Thus when you're trying to output black, there will be a 'hot area' where the two projectors are now overlapping, of twice the projector's 'black level' output.

The solution is to adjust the 'Eb comp cent' value (the first in the 'Eb comp cent/side' menu) to compensate for this centre brightness error. By increasing this value, it will increase the brightness of the non-overlap area.

To get this value right, you must first make sure that the units connected to the projectors are outputting black – e.g. in the Adjust windows menu you can disable the output. Then increase the 'Eb comp cent' value until the non-overlap area's brightness has increased to be the same as the overlap (centre) area.

The 2nd value ('Eg comp side') is for where horizontal and vertical edge blending is being performed – e.g. a 2x2 arrangement. This value increases the brightness of the overlapping areas, with the exception of the centre 'square' where all projectors overlap.

Aspect ratio adjustment

Since your original video source is probably 16:9 (or a similar aspect ratio), it will also be necessary to change your vertical zoom value differently to the horizontal one. This is best done after projector alignment by performing the following:

1. Go to the 'Adjust windows' menu and change 'Aspect adjust' to 'Advanced'. This enables separate H and V zoom adjustments.
2. Go to 'Adjust windows' for Output 1 (1A) and you will now be able to adjust the vertical zoom independently of the horizontal zoom. H zoom should be left as it is, so adjust the V zoom until the correct aspect ratio of your output is achieved.
3. Go to 'Adjust windows' for Output 2 (2B) and adjust the V zoom to the same value as Output 1 (1A).

Locking both outputs together

If your video source contains live (moving) video then it is worthwhile locking one channels' output to the other's – this will eliminate any line or frame drift, which may cause frame-rate conversion problems. This is best done by locking Output 2 to Output 1.

For dual-channel units such as the C2-7000 series, perform the following:

1. Go to 'Adjust outputs'
2. Ensure that '2B' is selected – press Toggle 1 / 2 (Shift-1) if not.
3. Where 'Lock [Off] RGB1' is seen (where RGB1 is the default Lock source), change the Lock source to 'OUT1'.
4. Then change the Lock method from 'Off' to 'Genlock'.

For single-channel units (such as the C2-1000 and C2-2000 series) you can probably only perform locking if RGB1 is available for use (i.e. you are using CV1 or YC1 as your video source). If so, perform the following:

1. Either use a 2nd output from the unit with Output 1, or a distribution amplifier to generate a 2nd identical signal. Feed this into RGB1 on the unit handling Output 2.
2. Go to 'Adjust outputs' for Output 2
3. Where 'Lock [Off] RGB1' is seen (where RGB1 is the default Lock source), change the Lock source to 'OUT1'.
4. Then change the Lock method from 'Off' to 'Genlock'.

Other setup approaches

The previous setup method relies on your projectors being moved and aligned to the 190% zoom factor. Other setup approaches are also used where the zoom factor is adjusted to the projectors' current position – for instance if they are already fixed into their final positions.

Assuming your projectors are in fixed positions and you can't move them, you will need to adjust the 'E.blnd' H-size for both Outputs 1 and 2 to be the same values such that they overlap, creating the yellow lines mentioned earlier. You will then need to adjust the zoom values according to the formula given earlier. For various zoom and output resolutions, the following values for the edge blending H-size can be used:

Table showing Zoom% values for various Horizontal resolutions and edge blend H size overlaps.

E.blnd H	640x480	800x600	1024x768	1280x720	1280x1024	1600x1200	1920x1080i
50	192	194	195	196	196	197	197
55	191	193	195	196	196	197	197
60	191	193	194	195	195	196	197
65	190	192	194	195	195	196	197
70	189	191	193	195	195	196	196

E.blnd H	640x480	800x600	1024x768	1280x720	1280x1024	1600x1200	1920x1080i
75	188	191	193	194	194	195	196
80	188	190	192	194	194	195	196
85	187	189	192	193	193	195	196
90	186	189	191	193	193	194	195
95	185	188	191	193	193	194	195
100	184	188	190	192	192	194	195
105	184	187	190	192	192	193	195
110	183	186	189	191	191	193	194
115	182	186	189	191	191	193	194
120	181	185	188	191	191	193	194
125	180	184	188	190	190	192	193
130	180	184	187	190	190	192	193
135	179	183	187	189	189	192	193
140	178	183	186	189	189	191	193
145	177	182	186	189	189	191	192
150	177	181	185	188	188	191	192
155	176	181	185	188	188	190	192
160	175	180	184	188	188	190	192
165	174	179	184	187	187	190	191
170	173	179	183	187	187	189	191
175	173	178	183	186	186	189	191
180	172	178	182	186	186	189	191
185	171	177	182	186	186	188	190
190	170	176	181	185	185	188	190
195	170	176	181	185	185	188	190
200	169	175	180	184	184	188	190
205	168	174	180	184	184	187	189
210	167	174	179	184	184	187	189
215	166	173	179	183	183	187	189
220	166	173	179	183	183	186	189
225	165	172	178	182	182	186	188
230	164	171	178	182	182	186	188
235	163	171	177	182	182	185	188
240	163	170	177	181	181	185	188
245	162	169	176	181	181	185	187

E.blnd H	640x480	800x600	1024x768	1280x720	1280x1024	1600x1200	1920x1080i
250	161	169	176	180	180	184	187
255	160	168	175	180	180	184	187
260	159	168	175	180	180	184	186
265	159	167	174	179	179	183	186
270	158	166	174	179	179	183	186
275	157	166	173	179	179	183	186
280	156	165	173	178	178	183	185
285	155	164	172	178	178	182	185
290	155	164	172	177	177	182	185
295	154	163	171	177	177	182	185
300	153	163	171	177	177	181	184
305	152	162	170	176	176	181	184
310	152	161	170	176	176	181	184
315	151	161	169	175	175	180	184
320	150	160	169	175	175	180	183
325	149	159	168	175	175	180	183
330	148	159	168	174	174	179	183
335	148	158	167	174	174	179	183
340	147	158	167	173	173	179	182
345	146	157	166	173	173	178	182
350	145	156	166	173	173	178	182
355	145	156	165	172	172	178	182
360	144	155	165	172	172	178	181
365	143	154	164	171	171	177	181
370	142	154	164	171	171	177	181
375	141	153	163	171	171	177	180
380	141	153	163	170	170	176	180
385	140	152	162	170	170	176	180
390	139	151	162	170	170	176	180
395	138	151	161	169	169	175	179
400	138	150	161	169	169	175	179

3D video

The setup of 3D video processing can be quite complex. It is recommended that the CORIOtools Suite program is used to help with this.

General information

3D Video is supported by extending certain CORIO2 unit's abilities as follows:

1. Addition of the 'Vendor Specific Data Block' into the EDID data for the source to read.
2. Addition of the 'Vendor Specific Infoframe' into the HDMI signal sent to the display, which informs the TV that a 3D resolution is being sent.
3. Addition of the extra 3D resolutions, supporting Frame Packing.

The processing of the left / right 3D images is handled by different scaling engines, such that left / right images can be either split from a single frame (2x Zooms), or merged into a single frame (2x PIPs).

Frame packed 3D video resolutions

Frame packing is the simplest form of putting two images (left and right) into a single video resolution. Effectively, the left image is sent first followed by the right image – but with no vertical sync between them (instead, there is a blanking area). Video bandwidth is doubled, which then means that the pixel rate is also doubled – and hence both left and right are sent together at the same frame rate as they were individually.

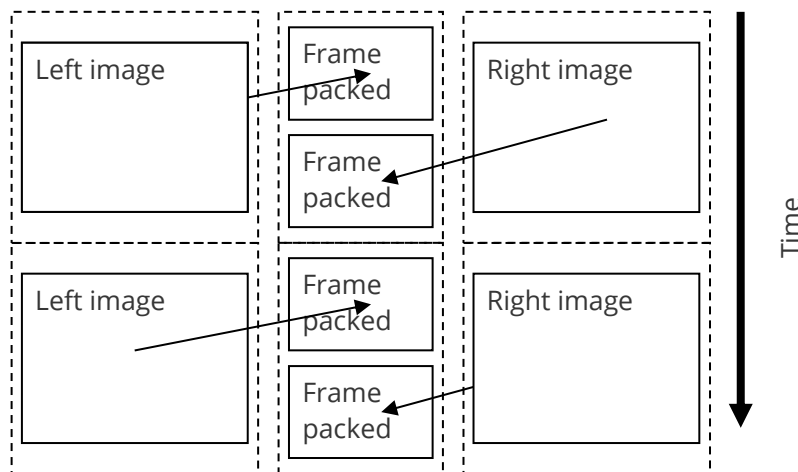

Because the video pixel rate has to be doubled in order to fit twice as many frames in during the same amount of time, only resolutions that are of low enough pixel rate can be doubled and still be within the DVI / HDMI pixel rate limit. These are:

		Frame rates available		
Resolution	720p 3D	50Hz	59.94Hz	60Hz
	1080p 3D	23.98Hz	24Hz	25Hz

In the above, the normal 74.25MHz pixel rate is doubled to 148.5MHz in order to handle 3D Frame packing of left / right images. These resolutions have been added to the CORIO2 resolution database.

For example, the 1280x720p 60Hz 3D resolution is actually composed of a single frame of 1470 active lines (plus another 30 for the vertical sync area). The Left 720 lines are placed at the top, followed by 30 lines of blank lines (but no vertical sync), then the other Right 720 lines.

Similarly, 1080p 24Hz 3D is composed of 2205 active lines (plus another 45 for the vertical synd). Each Left / Right frame is 1080 lines long, with a blanking area in the middle of 45 lines.

Scaling of 3D resolutions using a single CORIO2 scaler

To the CORIO2 unit, the new 3D Frame-packed resolutions (720p 3D and 1080p 3D) are just larger than usual images with some blanking area in the middle. Hence, they can be scaled to different resolutions with no problem – and will retain the blanking area in the middle.

If they are scaled to another 3D resolution (e.g. 1080p 3D to 720p 3D), this blanking area will remain in the correct place for Frame packing. Hence, a single scaler can support such a conversion. However, 1080p 3D frame-rate conversion (e.g. 1080p 23.98Hz 3D to 1080p 25Hz 3D) will suffer from reduced vertical resolution, since the total numbers of lines including the blanking area will be beyond the scaler’s 2048 line limit.

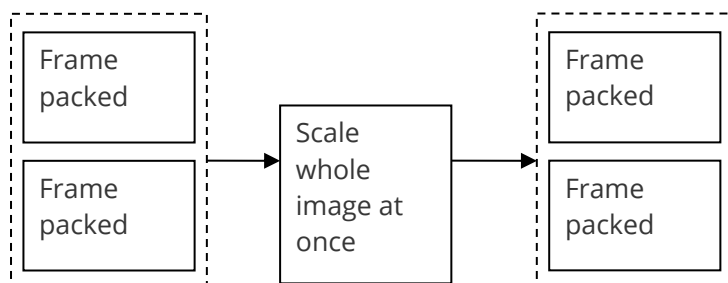

The following table shows what scaling can be achieved using a single CORIO2 scaler:

		Frame packed output resolution	
		720p 3D	1080p 3D
Frame packed input resolution	720p 3D	Yes	Yes
	1080p 3D	Yes	No*

*Reduced quality

Note, however, that Zoom and Shrink (along with the associated Crop, Pan, Pos, etc.) are not available for use – since they would zoom into only one of the Left / Right images and the 3D Frame packing effect would be broken.

A 3D resolution could also be converted to a non-3D resolution using a 1st scaler (e.g. 1920x1080p 60Hz), sent over a 3G-SDI cable, and converted back to a 3D resolution using a 2nd scaler. In both cases, the scalers will correctly maintain the blanking area in the middle of the image.

E.g. 720p 3D 24Hz -> 1080p 24Hz -> 720p 3D 24Hz.

However, bear in mind that the overall resolution of 720p 3D is 1470 lines (720 x2 + 30), which when scaled to 1080 lines and back to 1470 lines will cause a slight image quality loss.

Scaling of 3D resolutions using two CORIO2 scalers

For units with multiple scalers, more options are available for scaling.

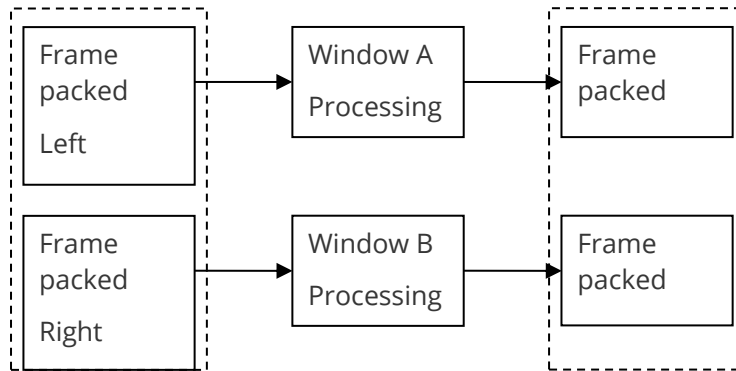

Along with the resolution scaling shown above, a scaler can be dedicated solely for use with each Left and Right image. This allows the 1080p 3D frame-rate conversion to be possible:

		Frame packed output resolution	
		720p 3D	1080p 3D
Frame packed input resolution	720p 3D	Yes	Yes
	1080p 3D	Yes	Yes

In order to dedicate a scaler per Left / Right channel, the Zoom and Pan values for each window need to be set correctly in order to solely capture a single Left or Right image. Also, when outputting the signal as a single Left / Right composite image, the Shrink and Pos values for each window need setting correctly. The exact values to use depend on the resolution coming in and going out.

It also means that Zoom and Shrink can be used – although care must be taken to set the Zoom and Shrink values correctly to maintain the correct Frame packing setup (i.e. you need to Zoom into the centre of the relevant Left or right image, and set your Shrink position to the centre of the relevant Left or Right image).

2x Camera inputs to 3D resolutions using two CORIO2 scalars

By using 2 scalars, a single camera source can be fed into each scaler, with the resulting windows output to a single 3D resolution (one above the other) – as per Frame packing mode. This then allows real-time conversion of camera sources to a 3D video signal.

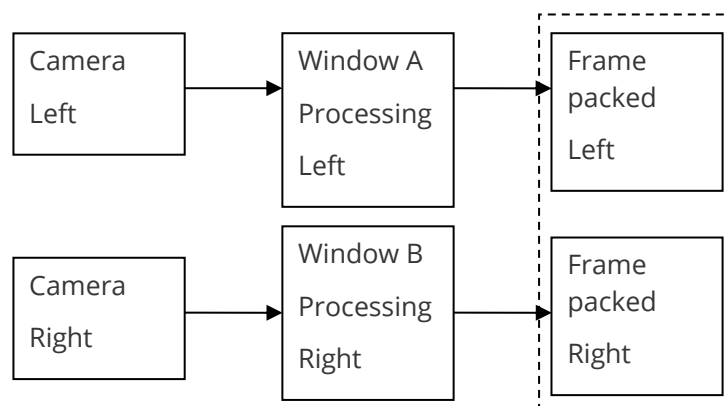

		Frame packed output resolution	
		720p 3D	1080p 3D
Camera input resolution	Any	Yes	Yes

Alternatively, the same setup could be used to convert the 2 camera signals into a standard video resolution (again, with Left at the top, and Right at the bottom) and sent over fibre, SDI, or recorded to Blu-ray. A separate unit could then scale that 'pseudo-3D' signal back to a standard 3D resolution for display.

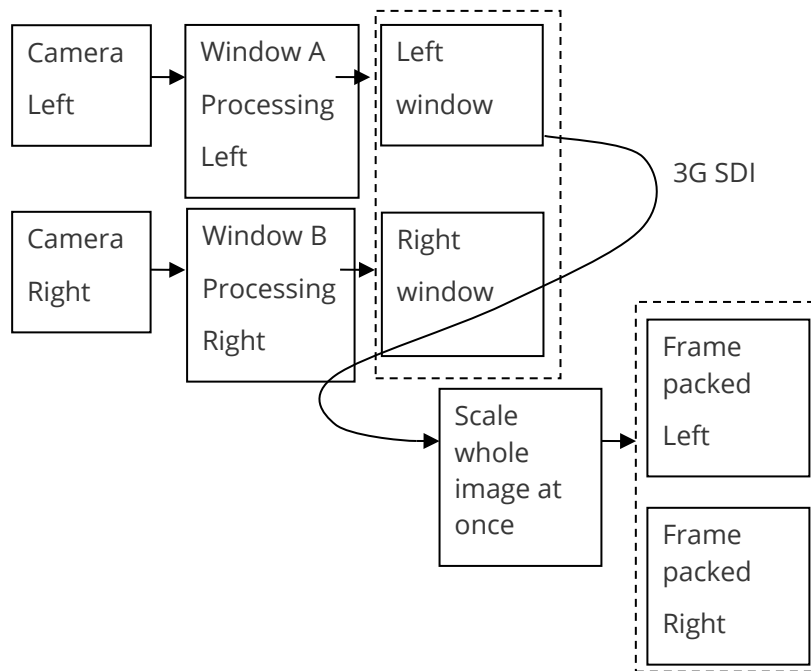

The Cameras can output any resolution – from PAL/NTSC right up to 1920x1080p.

Note that unless both Cameras are genlocked together (a feature usually only found on more expensive cameras), it's possible that their output frames might drift from each other. This may result in out of sync Left / Right images (by +/- 1 frame).

3D resolutions to 2x Projectors using two CORIO2 scalars

By using 2 scalars, a single 3D resolution can be split and fed to individual outputs – so that each Left and Right image can be fed to projectors with different polarizing filters.

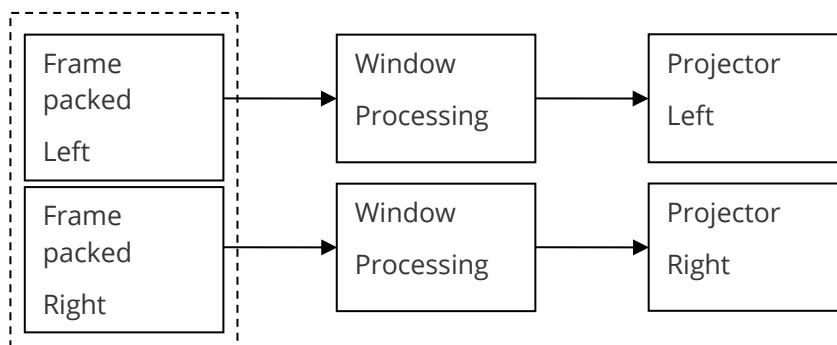

Note that this requires either a single unit with 2x scalers and 2x outputs, or a 3D-compatible Distribution Amplifier (DA) along with 2x individual scalers.

		2x Output Resolution
3D Frame packed input resolution	720p 3D	Any output resolution
	1080p 3D	in the scaler's database

If 2x individual scalers are used, it is recommended that they are genlocked to a common reference source – otherwise their outputs may drift and become out of sync from each other (by +/- 1 frame).

3D Picture-in-Picture

A PIP can be added to a 3D resolution, with the PIP made to appear 'floating' out in front of the background video. This requires a unit with 2x scalers (and at least two inputs, one for Frame packed 3D, and one for the PC/Video PIP source), both taking the same PIP source and placing the PIP slightly offset in each Left / Right frame.

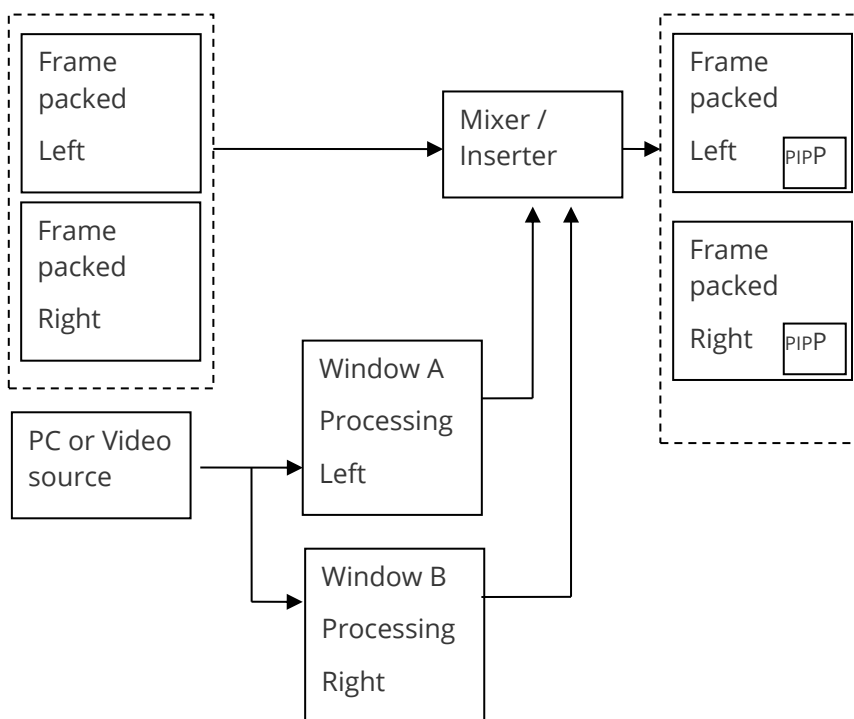

In order to achieve this, the CORIO2's 'LockandMix' mode is required, so that the background Frame-packed 3D source can pass through untouched – except for the insertion of the extra 2x PIPs from the scalers.

Each scaler needs to offset the Left and Right PIPs differently in the horizontal direction, but they must be the same relative vertical direction. The Left image needs offsetting to the right, and the Right image needs offsetting to the left.

		Frame packed output resolution with PIP	
		720p 3D	1080p 3D
Frame packed input resolution	720p 3D	Yes	Yes
	1080p 3D	Yes	Yes

It is not recommend that the PIP is made to go back 'into' the screen, as this will 'break' the 3D effect if the existing 3D background tries to go in front of it.

Other types of 3D resolution / Transcoding between them

Frame Packing is not the only way to transmit a Left / Right pair of images. 'Top-Bottom' and 'Side-by-Side' are also available, although in most cases they reduce the image quality as they squeeze two frames into the same signal bandwidth usually occupied by one.

In the case of 1920x1080p60 Top-Bottom, two 1920x540 frames are placed one above the other (with no gap between them). Thus half the vertical resolution of each frame is lost.

For 1920x1080p60 Side-by-Side, two 960x1080 frames are placed next to each other (again, with no gap between them). Thus half the horizontal resolution of each frame is lost.

Whilst there are uses for these two methods, the loss of quality is not usually worth the benefit of the extra frame rate (60Hz) obtained. Since most movies are filmed at 24Hz (film frequency), 60Hz is not usually required.

CORIO2 units that have at least two scalers are compatible with 'Top-Bottom' and 'Side-by-Side' 3D resolution inputs, and can then process them (and also convert them into the 'Frame packing' method previously described). This is done by setting each Window to process just one of the Left / Right pair of images.

Note, however, that outputting 'Top-Bottom' and 'Side-by-Side' may not be compatible with all displays as the relevant HDMI Vendor-Specific Infoframe data is not yet available in CORIO2 units.

CORIO2 units suitable for 3D processing

The table below shows which CORIO2 units are capable of processing 3D as described in this document. Please refer to the preceding sections for any relevant notes and comments.

Unit	3D image scaling (without Zoom and Shrink)	3D image scaling (with Zoom and Shrink)	2x Cameras to 3D	3D to 2x outputs	3D PIP	3D Trans-coding
C2-2200A C2-2205A C2-2250A C2-2255A C2-2350A C2-2355A C2-2375A	Yes	No	No	**With 2x units + DA	No	No

Unit	3D image scaling (without Zoom and Shrink)	3D image scaling (with Zoom and Shrink)	2x Cameras to 3D	3D to 2x outputs	3D PIP	3D Trans-coding
1T-C2-750	Yes	Yes	Yes	**With 2x units + DA	Yes	Yes
1T-C2-760	Yes	No	No	**With 2x units + DA	With 2x units + DA	No
C2-6104(A)	Yes	Yes	Yes	**With 2x units + DA	Yes	Yes
C2-8000	Yes	Yes	Yes	Yes	Yes	Yes

Serial port

Connection

Your unit is fitted with a standard 'D9' plug or socket allowing it to be controlled from a computer or other type of terminal or console with a similar interface. Most computers fitted with an RS232 port, known as a 'COM' port, will have a 'D9' plug on them. To enable connection between the two devices you will require one of two cables as shown below:

D9 connector type on C2 unit	RS232 cable type required for linking to PC
Plug – common on earlier C2 units	'Null-modem' D9 socket to socket
Socket – common on recent C2 units	D9 plug to socket

Should your PC not have an RS232/COM port, it is possible to add an interface card into the PC to add this facility. Another option you could use is a USB to RS232 converter. Both methods will add a COM port to your PC, although you should be aware that these generally do not default to being 'COM1' which is the default most RS232 applications will use.

Some units are also RS-422/485 capable – see the Specifications section for more details.

The default baud rate is 57600 with 8 data bits, 1 stop bit and no parity. This baud rate can be changed in the System menu to suit other programs if need be.

Communications protocol

The standard communications protocol for your unit is text-based and is detailed on our website. Also on our website, you can find the Windows Control Panel or CORIO®tool Suite for your unit.

The protocol is also bi-directional (unit and computer both send messages to each other), so that you can send changes to the unit, and it will also respond with any changes made via alternate methods (front panel buttons, menu changes and infra-red control). This enables any attached computer to be aware of any changes made to the unit from an alternative source rather than itself.

What this means is that you can easily find out the exact command to send to the unit to tell it to perform a certain function. This can be seen by the data that is sent back to the computer when changing values on the unit. For instance, just by turning FREEZE on, by pressing the FREEZE button, will cause RS232 data to be sent

to the computer that represents the command required to set FREEZE on. A second press, to turn FREEZE off, then sends the computer the command required to turn the FREEZE off.

Note: Any command you send to the unit will be replied to either with an error code or with the actual changed value. This may be different to the one you sent; for example, if trying to set a value too high or too low.

Ethernet port

Connection

Your unit is fitted with an Ethernet port allowing it to be controlled across a local network using the Window Control panel, CORIOtools or a 3rd party control system. The host computer will need an IP address in the same range as defined in the scaler, the default scaler values are:

IP Address 10.1.2.123

Netmask 255.255.255.0

The host computer should therefore be set as below where xxx is any value except 123 as this is used for the scaler.

IP Address 10.1.2.xxx

Netmask 255.255.255.0

The connection to the scaler may either be through a network hub or via a crossover cable as detailed below:

Signal	Color	From	To	Signal
TX-	Orange	2	6	RX-
RX+	White/Green	3	1	TX+
-	Blue	4	7	-
-	White/Blue	5	8	-
RX-	Green	6	2	TX-
-	White/Brown	7	4	-
-	Brown	8	5	-

The Ethernet port uses the same protocol as defined in the following section for Serial control.

Serial / IP control specification

PLEASE NOTE: Not all units support Serial and/or IP (Ethernet) communications – check to see if this feature is present on your unit.

This section outlines how to control a unit via a Serial or Ethernet link (if fitted to your unit), using ASCII-based commands. It details how to send and receive serial data to perform many of the functions that a user has access to on the unit.

Not all units will support the full range of adjustments listed – this will depend on the complexity of the unit you have.

Communication protocol basics

Packets of ASCII data containing hexadecimal numbers are exchanged between the unit and controller via a Serial or IP link (you cannot use both at the same time).

The Serial standard is 57600 baud, 8 bits, no parity and 1 stop bit, although this can be changed by the user (see 'System' menu).

No flow control is used - however all control packets start with an ASCII 'F', end with carriage-return (13 decimal, 0x0D hexadecimal) and all such packets sent to the unit will be acknowledged (thereby provided software handshaking). Note that a line-feed (LF) should not be sent.

It may take around 30ms (0.03 seconds) for an RS232 command to be actioned and acknowledged - this will vary between different models.

ASCII-hex data is used where a number is encoded into its hexadecimal equivalent with leading zeros - e.g. Where '00' is decimal value 0, '80' is decimal 128 and 'FF' is decimal 255. In other words, two characters are sent for each byte encoded.

Any gap of more than 1 second between the characters of a control command sent will cause a time-out - and previous characters sent will be lost.

Write packets (sending command functions to the unit) are always 20 characters long (including a carriage return at the end). The unit will respond with a full 20 character message indicating what has changed. This returned payload will reflect the actual value of the parameter changed. If the user requests a value out of bounds then the limit value is used, and the payload will then reflect the limited value used.

Read packets (sent to request information from the unit) are always 14 characters long (including a carriage return at the end), the response from the unit will be a 20 byte message with the Write flag (since it is 'writing' the value back to the host) and the ACK flag set.

The ACK flag will be returned as 0 if the command is invalid for some reason - for example a bad FUNCTION, WINDOW, OUTPUT or PAYLOAD value. An ACK=0 message will be otherwise identical to the one you sent, so you know exactly which message has the error.

Any changes made to the unit using the front panel controls will also cause the full 20 byte message to be sent indicating the change that has occurred, thus enabling a program to stay 'in-sync' with the unit. In some cases (such as the execution of a macro) multiple 20 bytes messages will be sent indicating all the parameters that have been changed.

Only one message should be sent to the unit, another message can't be sent until a specific response is received from the unit (the user should look for a message with the same WINDOW, OUTPUT and FUNCTION values as they sent). If no message is received back within 1 second, there is likely to be a hardware communication problem (or wrong baud rate, etc.).

If absolutely required, to simplify programming the user may send packets one after the other with around 100ms (100 milliseconds) between each one. However, this will not work for all packets (such as Zooming into Still Images / Testcards or changing Logos) since this will cause the unit's micro-controller to be busy, so the user must experiment and satisfy themselves that this is possible.

Packet format

Below is a representation of data bytes in a single packet for a 'Write' to the unit to set a value:

SOP	CMD	CHA	WINDOW	OUTPUT / FUNCTION	FUNCTION	PAYLOAD x 3	CS	EOP
-----	-----	-----	--------	----------------------	----------	-------------	----	-----

Below is a representation of data bytes in a single packet for a 'Read' to the unit to get a value:

SOP	CMD	CHA	WINDOW	OUTPUT / FUNCTION	FUNCTION	CS	EOP
-----	-----	-----	--------	----------------------	----------	----	-----

The table below details the function of each part of the packet:

Packet part	Function
SOP (Start of packet)	This is always the ASCII letter 'F' to indicate the packet start.
CMD (Command)	<p>ASCII-hex byte to indicate the type of command being sent.</p> <p>Each bit in the byte has a different function. Currently only the following bits are defined:</p> <p>Bit 7 = Write (0) or Read (1) request. Messages from the unit are always Writes.</p> <p>Bit 6 = ACK bit. Should be set to 0 for messages to the unit. ACK=1 returned means message was okay. ACK=0 returned means an error was present in the message.</p> <p>Bit 5 = 0 Reserved for future use.</p> <p>Bit 4 = 0 Reserved for future use.</p> <p>Bit 3 = 0 Reserved for future use.</p> <p>Bit 2 = 1 This bit <i>*must*</i> be set.</p> <p>Bit 1 = 0 Reserved for future use.</p> <p>Bit 0 = 0 Reserved for future use.</p>
CHA (Channel) SOURCE or MACRO NUMBER	<p>This byte has multiple uses, and defaults to 0 unless used for:</p> <p><u>CHA</u></p> <p>When a channel number is used in the Adjust Sources section (see later).</p> <p><u>SOURCE</u></p> <p>Byte to indicate the source channel to be altered (if appropriate).</p> <p>0x10 = RGB1, 0x11 = RGB2, 0x12 = RGB3, etc.</p> <p>0x30 = CV1, 0x31 = CV2, 0x32 = CV3, etc.</p> <p>0x40 = YC1, 0x41 = YC2, 0x42 = YC3, etc.</p> <p>0x50 = SDI1, 0x51 = SDI2, etc.</p> <p>0xD0 = OUT1, 0xD1 = OUT2, etc.</p> <p>0xF0 = TC1, 0xF1 = TC2, etc.</p> <p><u>MACRO</u></p> <p>Or – for Macro related commands:</p> <p>Bit 7..4 = 0 Reserved</p> <p>Bit 3..0 = Macro number</p>
WINDOW / LOGO / BORDER	<p>Bit 7 = 0 (Reserved).</p> <p>Bit 6..0 = Represents the window to be adjusted (for multi-channel units only).</p> <p>E.g. Window 'A' (the default for single-channel units) is sent as '41' since 0x41 is ASCII for 'A'. 0x61 is ASCII for 'a' (a Logo) and is sent as '61'.</p>
OUTPUT &	<p>Bit 7..4 = Number representing the output to adjust 0 = Output 1, 1 = Output 2 (for multi-channel units).</p> <p>Bit 3..2 = Reserved (set to 0).</p>

FUNCTION HIGH	Bit 1..0 = Bits 9 & 8 of the function code. (Remainder of bits [7..0] are in FUNC LOW.) E.g. If the function code is 0x234, and we want to adjust Output 2, then this byte is 0x12
FUNCTION LOW	ASCII-hex byte to indicate the lowest 8 bits of the actual function to set or receive (e.g. change Zoom value). A later table details all the functions available.
PAYLOAD x 3 bytes	A series of ASCII-hex bytes carrying the data to send. Read requests have no payload - the payload is in the data sent back. Write packets require a payload, and this is always in 'triple-bytes' - i.e. 3 bytes are required, MSB first. e.g. '000001' is 1 in decimal, '010000' is 65536 in decimal, and 'FFFFFF0' is -16 in decimal.
CS	ASCII-hex byte that is the (check) sum of all previous bytes (excluding the SOP 'F' character). E.g. The command F0400410082000001C8 has the checksum of 04+00+41+00+82+00+00+01=C8, so the complete command to send is F0400410082000001C8. A short-cut for debugging allows the checksum to be replaced by 2 question marks, so in the previous example you could send F0400410082000001??. Instead. This is purely for test and debugging - you should normally use a checksum to ensure data validity.
EOP	This is a carriage return (no line-feed) - ASCII code 13 (decimal).

Function list

These are grouped together into their associated on-screen menus.

Your unit and this manual should be used to determine the actual function of each of the following, as only the menu text is listed here. Where an equivalent menu item does not exist on your unit, then that feature is not supported on.

Function codes are given in hexadecimal and adjustment range is in decimal (but always sent as hexadecimal!).

For dual-channel units the mode of operation also restricts what Window and Output can be used the following table shows the allowed combinations:

Mode	Allowed Window and Output combinations
Switcher	Output 1 (0x00) and Window A (0x41) / Z (0x5A) / Logo a (0x61)
Independent	Output 1 (0x00) and Window A (0x41) / Z (0x5A) / Logo a (0x61) OR Output 2 (0x01) and Window B (0x42) / Z (0x5A) / Logo b (0x62)
Dual PIP	Any combination of Output and Window

The following table is a list of all menu functions, their related function number and valid range of adjustment.

Note: not all items will be available on all units. If your unit does not show the menu text in the menus then that function is not supported.

Menu text	CHA	FUNC (Hex)	Range of adjustment (decimal)
Top level			
Mode (Dual-channel units only)		109	0 = Switcher 1 = Independent 2 = Dual PIP
Preset number		225	1 to 10
Preset load		226	Set to 1 to load – automatically resets to 0.
Preset store		227	Set to 1 to store – automatically resets to 0.
Preset erase		228	Set to 1 to erase – automatically resets to 0.
Adjust outputs			
Output enable		170	0=Blanked, 1=Active
Lock source (connector)		149	0x10 to 0x1F = RGB1 to RGB16 0x30 to 0x3F = CV1 to CV16 0x40 to 0x4F = YC1 to YC16 0x50 to 0x5F = SDI1 to SDI16 0xD0 = OUT1, 0xD1 = OUT2 0xF0 = TC1, 0xF1 = TC2
Lock method		10A	0 = Off 1 = Genlock 2 = Lock & Mix 3 = DARSlock (some units only) 4 = Frm.lock (some units only)
Lock H Shift		14A	-4096..4096
Lock V Shift		14B	-4096..4096
Output resolution		083	1..1000
Output image type		0E2	0 = RGBHV 1 = RGBS 2 = RGsB 3 = YUV 4 = tYUV 7 = tIRGB
Output image type digital		16C	0 = RGBHV 3 = YUV
HDCP required		233	0..1, Off, On (if display supports it)
HDCP status		234	0=Unavailable

Menu text	CHA	FUNC (Hex)	Range of adjustment (decimal)
			1=Supported 2=Active 3=Repeater supported 4=Repeater active 5=No display (Other values indicate various HDCP authentication states.)
Allow errors		2B4	0 = Off 1 = On
Background Y		13B	16..235
Background U		13C	16..240
Background V		13D	16..240
SDI optimization		197	0..1, Off, On
Output Standard		101	0 = NTSC/PAL 1 = PAL-M/PAL-N 2 = SECAM
Output CV/YC IRE		133	-7.5..12.5
Output CV/YC Hue (degrees)		139	-22..22
Output SC/H Phase		085	-180..180
Output Luma Bandwidth		134	0,1,2 = Low, Medium, High
Output Chroma Bandwidth		135	0,1,2 = Low, Medium, High
Output Chroma delay		137	-4..3
PAL WSS		130	0 = Off 1 = 4:3 Full format 2 = 14:9 Letterbox centre 3 = 14:9 Letterbox top 4 = 16:9 Letterbox centre 5 = 16:9 Letterbox top 6 = >16:9 Letterbox centre 7 = 14:9 Full format 8 = 16:9 Full format
Take		11E	0->1 = Perform a Preview -> Program transition
Audio amp. Volume		201	-16 to 15
AES/SDI Chan. 1 source		20B	0x00 to 0x07 = SDI1-1 to SD1-8

Menu text	CHA	FUNC (Hex)	Range of adjustment (decimal)
AES/SDI Chan. 2 source		20C	0x08 to 0x0F = SDI2-1 to SDI2=8 0x10 to 0x1F = AES1 to AES16 0x20 = AFV (audio follow video)
AES/SDI Chan. 3 source		20D	
AES/SDI Chan. 4 source		20E	
AES/SDI Chan. 5 source		20F	
AES/SDI Chan. 6 source		210	
AES/SDI Chan. 7 source		211	
AES/SDI Chan. 8 source		212	
Allow HDMI output		288	0=DVI only, 1=Use HDMI if supported
HDMI/SDI audio routing		268	0=Mute, 1=On, 2=WinA
HDMI/SDI 'On' source		269	0x10 onwards for DVI-U1, etc. 0x50 = SDI1 0x51 = SDI2
H.phone monitor		289	Headphone source 0=AES1 output ... 7=AES8 output
H.phone volume		28A	0=+6dB ... 15=-40dB
Adjust windows			
Program source / Window source (connector)		082	0x10 to 0x1F = RGB1 to RGB16 (Also includes DVI / YUV sources) 0x30 to 0x3F = CV1 to CV16 0x40 to 0x4F = YC1 to YC16 0x50 to 0x5F = SDI1 to SDI16 0xD0 = OUT1, 0xD1 = OUT2 0xF0 = TC1, 0xF1 = TC2
Select Universal source		241	0xE0 to 0xEF select universal inputs 1 to 16
Source resolution		0F8	Read only – returns # of resolution
Window Enable		12B	0..1 = Off, On
Zoom level %		086	100..1000
Zoom level H %		103	100..1000 (only used in Advanced A/R mode)
Zoom level V %		105	100..1000 (only used in Advanced A/R mode)
Aspect ratio in		107	0.1:1..9.99:1 (read only)
H/V zoom pan % (H)		09F	0..100
H/V zoom pan % (V)		0A0	0..100
Image freeze		09C	0..1 = Off, On
H/V crop % (H)		223	0..100

Menu text	CHA	FUNC (Hex)	Range of adjustment (decimal)
H/V crop % (V)		224	0..100
H/V out shift (H)		0AD	-4096..4096
H/V out shift (V)		0AE	-4096..4096
Shrink level %		087	10..100
Shrink level H %		104	10..100 (only used in Advanced A/R mode)
Shrink level V %		106	10..100 (only used in Advanced A/R mode)
Shrink enable		18E	0..1 = Off, On
H/V shr. pos.% (H)		0DA	0..100
H/V shr. pos.% (V)		0DB	0..100
In (top-left H)		21B	
In (top-left V)		21D	
In (H size)		21C	
In (V size)		21E	
Out (top-left H)		21F	
Out (top-left V)		221	
Out (H size)		220	
Out (V size)		222	
Aspect change		190	0..2 = Normal, Letterbox, Pillarbox
Aspect adjust		102	0..2 = Simple, Advanced, Pixel
Flicker reduction		092	0..3 = Off, Low, Med, High
Image smoothing		0A1	0..3 = Off, Med, High, Auto
Image flip		095	0..3 = Off, Horiz., Vertical, H & V
Temporal interpolation		229	0..1 = Off, On
Show source label		250	0..1 = Off, On
Audio bars		252	0=Off, 1 to 4 audio bars shown.
Max fade level		10F	0..100 = Fade level %
Fade out / in		193	-1 = Fade out 0 = No action 1 = Fade in
Layer priority		144	0..5 = Layer priority (Other layers are automatically moved.)
Headphone volume		0FD	-16..15 (-16=Mute)
Audio vol. (volume)		206	-128..127 (for digital audio processing)
Audio vol. (on/off)		207	0..1 = Off, On (for digital audio processing)

Menu text	CHA	FUNC (Hex)	Range of adjustment (decimal)
Adjust keyers (on certain models only)			
Keyer enable		127	0..1 = Off, On
Y key min/max (min)		0AF	0..255
Y key min/max (max)		0B2	0..255
Y key Softness		121	0..255
Y key Invert		122	0..1 = Off, On
U key min/max (min)		0B0	0..255
U key min/max (max)		0B3	0..255
U key Softness		123	0..255
U key Invert		124	0..1 = Off, On
V key min/max (min)		0B1	0..255
V key min/max (max)		0B4	0..255
V key Softness		125	0..255
V key Invert		126	0..1 = Off, On
Swap fore / background		144	0..1 = Off, On
Adjust keyers - edge blending (on certain models only)			
Edge Blend		180	Bit 0 = Left edge active Bit 1 = Right edge active Bit 2 = Top edge active Bit 3 = Bottom edge active
E.blnd guides		18F	0..2 = Off, Auto, On
E.blnd size V		18C	0.. limited by V height
E.blnd gamma H		188	1..150 1=0.01, 150=1.50
E.blnd gamma V		18D	1..150 1=0.01, 150=1.50
E.blnd comp cent		198	0..99
E.blnd comp side		19D	0..99
E.blnd size Left		277	0.. limited by H width
E.blnd size Right		278	0.. limited by H width
E.blnd size Top		279	0.. limited by V height
E.blnd size Bottom		27A	0.. limited by V height
E.blnd gamma Left		27B	1..150 1=0.01, 150=1.50
E.blnd gamma Right		27C	1..150 1=0.01, 150=1.50
E.blnd gamma Top		27D	1..150 1=0.01, 150=1.50
E.blnd gamma Bottom		27E	1..150 1=0.01, 150=1.50

Menu text	CHA	FUNC (Hex)	Range of adjustment (decimal)	
Logos (on certain models only)				
Logo enable		12B	0..1 = Off, On	
Logo number		143	0..9 Logo selection	
H/V out shift (H)		0AD	0..100 %	
H/V out shift (V)		0AE	0..100 %	
Max fade level		10F	0..100%	
Layer priority		144	0..5	
Borders (on certain models only)				
Border enable		150	0..1 = Off, On	
Border H size		152	0..99	
Border V size		151	0..99	
Border H offset		153	0..99	
Border V offset		154	0..99	
Border Opacity		158	0 (fully transparent) ..100 (solid)	
Border Y		155	16..235	
Border U		156	16..240	
Border V		157	16..240	
Adjust sources				
Source to adjust. This only changes what's shown in the menu - use the CHA values below to change settings of a source.	CHA	116	0x10 to 0x1F = RGB1 to RGB16 0x30 to 0x3F = CV1 to CV16 0x40 to 0x4F = YC1 to YC16 0x50 to 0x5F = SDI1 to SDI16 0xD0 = OUT1, 0xD1 = OUT2 0xF0 = TC1, 0xF1 = TC2	
Still Image / Testcard	F0..F1	0DC	0..10	
Autoset	10..1F	0FE	1= Start Autoset procedure	
Aspect correct	10..5F	240	0=Fill (default) 1=Aspect, 2=H-fit, 3=V-fit, 4=1:1	
UMD display address	10..5F	263	0 to 126, as per TSL 3.1 protocol	
Label font	10..5F	246	0..15 to select different fonts	
Label background color	10..5F	247	0=Black	8=Transparent
Label foreground color	10..5F	248	1=Blue	9=Grey
			2=Green	10=Opaque Black
			3=Cyan	11=Opaque White

Menu text	CHA	FUNC (Hex)	Range of adjustment (decimal)	
			4=Red	12=Flashing Blue
			5=Magenta	13=Flashing Green
			6=Yellow	14=Flashing Red
			7=White	15=Flashing White
Label H. Size	10..5F	249	0..8	
Label V. Size	10..5F	24A	0..8	
Label H. Position	10..5F	24D	0..3 (Off / Left / Center / Right)	
Label V. Position	10..5F	24E	0..3 (Off / Top / Middle / Bottom)	
Label char. to adj.	10..5F	24B	0..23	
Label char. value	10..5F	24C	32..127	
EDID to use	10..1F	243	0..7 to specify EDID entries 1..Mon	
EDID capture entry#	10..1F	244	0..7 to specify EDID entries 1..Mon	
EDID capture Grab	10..1F	245	Set to 1 to Grab. Auto-resets to 0.	
HDCP advertise (DVI)	10..1F	237	0=Off, 1=On	
HDCP status (DVI)	10..1F	238	0=Inactive, 1=Active	
TL pos. adj. (left)	10..FF	0B6	-100..100	
TL pos. adj. (top)	10..FF	0B7	-100..100	
BR size adj. (right)	10..5F	0DE	-100..100	
BR size adj. (bottom)	10..5F	0DF	-100..100	
Audio input source (internal)	10..FF	242	0..4 Selects inputs 1 to 4 + Mute.	
OPTION audio input	10..FF	0D0	0..9 = Channels 1 .. 10 on A2-2000	
Audio vol	10..FF	0CF	-16..15 (-16=Mute)	
Bal	10..FF	0D1	-15..15	
On source loss (was Deglitch)	10..5F	0A3	0=Show, 1=Freeze, 2=Blue, 3=Black, 4=Remove	
Source stable (read only)		22A	0=Unstable, 1=Stable	
Input pixel phase	10..5F	091	0..31	
RGB input type	10..1F	0C1	8 = Auto 6 = D-RGB 11 = D-YUV 10 = A-RGB 12 = A-YUV For universal HD15 inputs:	

Menu text	CHA	FUNC (Hex)	Range of adjustment (decimal)
			5 = CV/YC For units with DVI-U inputs: 13 = CV (or A-CV) 14 = YC (or A-YC) For units with DVI-U 5x BNC breakouts: 15 = B-RGB 16 = B-YUV 17 = B-CV 18 = B-YC
RGB contr. (red)	10..1F	0C5	75..150
RGB contr. (green)	10..1F	0C6	75..150
RGB contr. (blue)	10..1F	0C7	75..150
YUV setup level	10..1F	23E	0=0 IRE, 1=7.5 IRE
De-int.	10..FF	0B8	0..6 = Normal, Auto, Film 3:2, M.comp.low, M.comp.med., M.comp.high, Frame/bob
(Film mode detected)	10..FF	0E3	0..1 = Not detected, Detected
Diagonal interpolation	10..FF	22B	0..1 = Off, On
Noise reduction	10..4F	23F	0..1 = Off, On
Bright	30..4F	0BB	0..180
Contrast	30..4F	0BC	0..180
Saturation	30..4F	0B9	0..180
Hue	30..4F	0BA	-180..180
Sharpness	30..4F	080	-7..+7
Luma delay	30..4F	0BD	-4..3
Video standard	30..4F	08A	0 = PAL BGDHI / NTSC M 1 = NTSC 4.43 50 / PAL 60Hz 2 = PAL N / NTSC 4.43 60Hz 3 = NTSC N 3.58 / PAL M 4 = NTSC-Japan 3.58 5 = SECAM 6 = B&W 50Hz / 60Hz
Field swap	10..FF	0C9	0..1 = Off, On (swaps odd/even fields)
Field Offset	10..FF	196	0..7 = -4..+3 (defaults to 4 = 0)
<i>For units with digital audio processing:</i>			

Menu text	CHA	FUNC (Hex)	Range of adjustment (decimal)
Audio channel 1	10..FF	213	0x00 to 0x07 = SDI1-1 to SD1-8 0x08 to 0x0F = SDI2-1 to SDI2=8 0x10 to 0x1F = AES1 to AES16
Audio channel 2	10..FF	214	
Audio channel 3	10..FF	215	
Audio channel 4	10..FF	216	
Audio channel 5	10..FF	217	
Audio channel 6	10..FF	218	
Audio channel 7	10..FF	219	
Audio channel 8	10..FF	21A	
Adjust audio (on certain models only)			
Source to adj		203	0x00 to 0x07 = SDI1-1 to SD1-8 0x08 to 0x0F = SDI2-1 to SDI2=8 0x10 to 0x1F = AES1 to AES16
Volume trim		205	-128 to 127
Delay adjust		204	-100 to 5000
Adjust transitions (on certain models only)			
Transition type		112	0..3 = Cut, Fade, Wipe, Push
Switching fade time		0F5	0 (off) to 50 (5.0 seconds)
Wipe type		145	0 = Left -> Right 1 = Right -> Left 2 = Up -> Down 3 = Down -> Up 4 = Diagonal 5 = Diamond
Wipe Size		146	10..2000
Adjust sources audio Control (C2-8000 Only)			
Audio delay		192	0..200 = delay in ms
Audio Control (S2-106AD Only)			
Sample frequency		191	0..4 = Bypass, 32, 44.1, 48, 96kHz
Audio delay		192	0..999 = delay in ms (restricted depending on Sample frequency)
Adjust tally (on certain models only)			
Tally mode		260	0 = Disabled 1 = Normal

Menu text	CHA	FUNC (Hex)	Range of adjustment (decimal)
			2 = Presets
Tally input number		261	1 to 8
Tally preset to load		262	1 to 50
Adjust resolutions			
Note: You MUST set the 'Image to adjust' value to the correct value first, and only then change the other values - otherwise you may be adjusting the wrong entry. The user should not adjust the 'Image to adjust' entry using the front panel whilst also accessing it via RS232			
Image to adjust		081	1..1000
Interlaced		0CA	0..1 = Off, On
H.freq.crse		0BE	10000..200000
H.freq.fine		0BF	10000..200000
H/V active (H)		096	64..2047
H/V active (V)		097	64..2047
H/V start (H)		08B	0..1023
H/V start (V)		08C	0..1023
Clks/l		08D	64..4095
Lines/f		08E	64..2047
H/V sync (H)		08F	8..1023
H/V sync (V)		090	1..1023
Sync polarity		094	0..3 = ++, +-, -+, --
System			
SW (Software version)		0D2	Read only
PT (Product type)		0C4	Read only
BT (Board type)		0C2	Read only
Advanced menus		11D	0..1, Off, On
Autoset Sense		0FF	0..3 = Low, medium, high, v.high
OSD on Power up		189	0..1, Off, On
RGB1 termination		199	0..2, Off, On, Auto
Store		0C8	Set to 1 to store
Buzzer		0CB	0..1 = Off, On
CC-300 A/B bus enable		202	0..1 = Off, On
Power cycles		0D6	Read only
Firmware updates		0DD	Read only
Hours in use		0D7	Read only

Menu text	CHA	FUNC (Hex)	Range of adjustment (decimal)
Resolutions		0D8	Read only
Number of Still Images / Testcards		0D9	Read only
Number of logos		14F	Read only
Board temp. (deg.C)		0CD	Read only
Air temp. (deg.C)		148	Read only
Regulators temp.(deg.C)		147	Read only
PLD temp. (deg.C)		111	Read only
Led brightness		12C	0..100
LCD backlight		200	0..1 = Off, On
LCD contrast		270	0..255
Serial type (See Specs to see if your unit supports all options)		251	0 = RS-232 1 = RS-422 2 = RS-485
RS232 Baud rate		0AB	0..6 = 9600, 19200, 28800, 33600, 38400, 57600, 115200
Fan speed (rpm)		0CE	Read only
Fan 1 status		271	0=OK
Fan 2 status		272	1=Fast
Fan 3 status		273	2=Slow
Fan 4 status		274	3=STOP
PSU 1 status		27F	0=Fault
PSU 2 status		280	1=NoPower 2=OK 3=Missing
TAC number 0		15D	Read only
TAC number 1		15E	Read only
TAC number 2		15F	Read only
TAC number 3		160	Read only
TAC number 4		161	Read only
TAC number 5		162	Read only
MAC number (IP port)		208	Read only – bytes reversed!
Not part of menu system			
System STANDBY		281	0 = Operating, 1 = In STANDBY mode

Menu text	CHA	FUNC (Hex)	Range of adjustment (decimal)																																																				
Front panel lock		0FC	0 = unlocked, 1 = locked																																																				
Emulate button press		24F	See section below.																																																				
Options installed or attached – read only		264	<p>24-bit number has a bit high to indicate that a unit is attached, or an option installed:</p> <table border="1"> <thead> <tr> <th>Bit</th> <th>Unit</th> <th>Bit</th> <th>Unit</th> </tr> </thead> <tbody> <tr> <td>0</td> <td>Audio switcher</td> <td>12</td> <td>S2-110CV</td> </tr> <tr> <td>1</td> <td>S2-106AD</td> <td>13</td> <td>S2-110YC</td> </tr> <tr> <td>2</td> <td>S2-105PC</td> <td>14</td> <td>S2-101AA</td> </tr> <tr> <td>3</td> <td>S2-105PCA</td> <td>15</td> <td>Ethernet</td> </tr> <tr> <td>4</td> <td>S2-109PC</td> <td>16</td> <td>Tally / UMD module</td> </tr> <tr> <td>5</td> <td>S2-105CV</td> <td>17</td> <td>-</td> </tr> <tr> <td>6</td> <td>S2-105CVA</td> <td>18</td> <td>-</td> </tr> <tr> <td>7</td> <td>S2-105YC</td> <td>19</td> <td>-</td> </tr> <tr> <td>8</td> <td>S2-105YCA</td> <td>20</td> <td>-</td> </tr> <tr> <td>9</td> <td>-</td> <td>21</td> <td>-</td> </tr> <tr> <td>10</td> <td>S2-108HD</td> <td>22</td> <td>-</td> </tr> <tr> <td>11</td> <td>S2-105DVIA</td> <td>23</td> <td>-</td> </tr> </tbody> </table>	Bit	Unit	Bit	Unit	0	Audio switcher	12	S2-110CV	1	S2-106AD	13	S2-110YC	2	S2-105PC	14	S2-101AA	3	S2-105PCA	15	Ethernet	4	S2-109PC	16	Tally / UMD module	5	S2-105CV	17	-	6	S2-105CVA	18	-	7	S2-105YC	19	-	8	S2-105YCA	20	-	9	-	21	-	10	S2-108HD	22	-	11	S2-105DVIA	23	-
Bit	Unit	Bit	Unit																																																				
0	Audio switcher	12	S2-110CV																																																				
1	S2-106AD	13	S2-110YC																																																				
2	S2-105PC	14	S2-101AA																																																				
3	S2-105PCA	15	Ethernet																																																				
4	S2-109PC	16	Tally / UMD module																																																				
5	S2-105CV	17	-																																																				
6	S2-105CVA	18	-																																																				
7	S2-105YC	19	-																																																				
8	S2-105YCA	20	-																																																				
9	-	21	-																																																				
10	S2-108HD	22	-																																																				
11	S2-105DVIA	23	-																																																				

Examples

Each example shows the packet sent to the unit and its response. When a byte is not required to be sent it is indicated by a '-' in the table below (since a Read is 6 bytes shorter than a Write). Each character shown below is sent as a ASCII character so F0400 is sent as 'F' '0' '4' '0' '0'.

Packet sent

SOP	CMD	CHA	WIN	OUT	FUN	PAY	CS	EOP

Packet returned

SOP	CMD	CHA	WIN	OUT	FUN	PAY	CS	EOP

Set output 1 window B Source to RGB2

F	04	00	42	00	82	000011	D9	CR
---	----	----	----	----	----	--------	----	----

F	44	00	42	00	82	000011	19	CR
---	----	----	----	----	----	--------	----	----

Set output 1 window A to Enable advanced aspect control

Note checksum is ?? for debugging

F	04	00	41	01	02	000001	??	CR
---	----	----	----	----	----	--------	----	----

F	44	00	42	01	02	000001	8A	CR
---	----	----	----	----	----	--------	----	----

Set 1A Shrink to 110 – invalid max for shrink is 100

F	04	00	41	00	87	00006E	??	CR
---	----	----	----	----	----	--------	----	----

F	44	00	41	00	87	000064	70	CR
---	----	----	----	----	----	--------	----	----

Read 1C Zoom level – invalid as window C does not exist

F	84	00	43	00	86	-	??	CR
---	----	----	----	----	----	---	----	----

F	04	00	43	00	86	000000	CD	CR
---	----	----	----	----	----	--------	----	----

Read 1B Zoom level

Zoom = 100

F	84	00	42	00	86	-	??	CR
---	----	----	----	----	----	---	----	----

F	44	00	42	00	86	000064	70	CR
---	----	----	----	----	----	--------	----	----

Set baud to 9600

Reply is at 9600 baud

F	04	00	42	00	AB	000000	F0	CR
---	----	----	----	----	----	--------	----	----

F	44	00	42	00	AB	000000	30	CR
---	----	----	----	----	----	--------	----	----

Set 1A Zoom = 300

F	04	00	42	00	86	00012C	F7	CR
---	----	----	----	----	----	--------	----	----

F	44	00	42	00	86	00012C	37	CR
---	----	----	----	----	----	--------	----	----

Set 1A Shrink to 50

F	04	00	42	00	87	000032	FE	CR
---	----	----	----	----	----	--------	----	----

F	44	00	42	00	87	000032	3E	CR
---	----	----	----	----	----	--------	----	----

Set 1A Shrink H Posn to 0

F	04	00	42	00	DA	000000	1F	CR
---	----	----	----	----	----	--------	----	----

F	44	00	42	00	DA	000000	5F	CR
---	----	----	----	----	----	--------	----	----

Set 1A Shrink V Posn to 100

F	04	00	42	00	DB	000064	84	CR
---	----	----	----	----	----	--------	----	----

F	44	00	42	00	DB	000064	C4	CR
---	----	----	----	----	----	--------	----	----

Reading and writing macros

Depending on the unit connected there can be up to 7 macros stored in the unit. These macros can be programmed to perform a specific task, for example enable PIP mode, Position pip window at H=0, V=0, Zoom in to 120%.

The WIN and OUT bytes are not used for macro reading or writing and should be set to WIN=1A and OUT = 0

The CHA byte indicates the macro we are programming / reading / running. Macro 1 to 5 are CHA 0..4, CHA=5 is restore, CHA 6..7 are Macros 6..7.

Macro Restore (CHA=5) is read only, the units restore state is set by sending the Store command (0C8).

Menu text	CHA	FUNC (Hex)	Range of adjustment (decimal)
Macro			
Run macro	0..7	F1	0..1 = Run, Erase macro
Number of items within macro	0..7	F4	Read Only
Function to adjust	0..7	F2	0..4095
Value	0..7	F3	Value for Function

Reading a previously stored Macro

In order to read a macro the following commands must be sent in this specific order – no other commands should be sent between these messages. The CHA in these cases relate not to the source but to the macro we are reading.

Packet sent

SOP	CMD	CHA	WIN	OUT	FUN	PAY	CS	EOP
F	84	01	42	00	F4	-	BB	CR

Packet returned

SOP	CMD	CHA	WIN	OUT	FUN	PAY	CS	EOP
F	44	01	42	00	F4	00002	FC	CR

Read number of items currently stored in Preset 2

F	84	01	42	00	F4	-	BB	CR
F	84	01	42	00	F4	-	BB	CR

Returned packet indicates 4 items available to read

F	44	01	42	00	F4	00002	FC	CR
F	44	01	42	00	F4	00002	FC	CR

Read the Function for the first item in the preset / macro

F	84	01	42	00	F3	-	BA	CR
F	84	01	42	00	F3	-	BA	CR

Payload is the Function stored – 86 = Zoom

F	44	01	42	00	F3	000086	780	CR
F	44	01	42	00	F3	000086	780	CR

Read the Data for the first item in the preset / macro

F	84	01	42	00	F2	-	B9	CR
F	84	01	42	00	F2	-	B9	CR

Payload is the data for the function – 100%

F	44	01	42	00	F2	000064	5D	CR
F	44	01	42	00	F2	000064	5D	CR

Read the Function for the second item in the preset / macro

F	84	01	42	00	F3	-	BA	CR
F	84	01	42	00	F3	-	BA	CR

Payload is the Function stored – 87 = Shrink

F	44	01	42	00	F3	000087	81	CR
F	44	01	42	00	F3	000087	81	CR

Read the Data for the second item in the preset / macro

F	84	01	42	00	F2	-	B9	CR
F	84	01	42	00	F2	-	B9	CR

Payload is the data for the function – 100%

F	44	01	42	00	F2	000064	5D	CR
F	44	01	42	00	F2	000064	5D	CR

The above example shows the read for all the items within macro 0. The first command reads the number of items available in the macro and resets the read address. Then the following items read the function and then the data for each of the items in the preset/macro. Following a read of the data for a macro internally

the next item in the macro is selected for reading so it is not possible to read the same item twice without first re-reading the number of items in the macro.

Writing to a macro

In order to read a preset / macro the following commands must be sent in this specific order – no other commands should be sent between these messages.

Packet sent

SOP	CMD	CHA	WIN	OUT	FUN	PAY	CS	EOP
-----	-----	-----	-----	-----	-----	-----	----	-----

Packet returned

SOP	CMD	CHA	WIN	OUT	FUN	PAY	CS	EOP
-----	-----	-----	-----	-----	-----	-----	----	-----

Clear macro

F	04	02	42	00	F1	000001	3A	CR	F	44	02	42	00	F1	000001	7A	CR
---	----	----	----	----	----	--------	----	----	---	----	----	----	----	----	--------	----	----

Write the function for first item in macro 3 = Zoom

F	04	02	42	00	F3	000086	C1	CR	F	44	02	42	00	F3	000011	01	CR
---	----	----	----	----	----	--------	----	----	---	----	----	----	----	----	--------	----	----

Write data for the first item = 100

F	04	02	42	00	F2	000064	9E	CR	F	44	02	42	00	F2	000011	DE	CR
---	----	----	----	----	----	--------	----	----	---	----	----	----	----	----	--------	----	----

Write the function for the second = shrink

F	04	02	42	00	F3	000087	C2	CR	F	44	02	42	00	F2	000011	02	CR
---	----	----	----	----	----	--------	----	----	---	----	----	----	----	----	--------	----	----

Write the data for the second item = 100

F	04	02	42	00	F2	000064	9E	CR	F	44	02	42	00	F3	000011	DE	CR
---	----	----	----	----	----	--------	----	----	---	----	----	----	----	----	--------	----	----

Run and Restore macros

Macros once programmed can be run by sending one of the following commands. By running macro 5 the unit can be restored to its previously saved state, when used in conjunction with the other macros this allows a default setup or baseline for the unit to be created.

Packet sent

SOP	CMD	CHA	WIN	OUT	FUN	PAY	CS	EOP
-----	-----	-----	-----	-----	-----	-----	----	-----

Packet returned

SOP	CMD	CHA	WIN	OUT	FUN	PAY	CS	EOP
-----	-----	-----	-----	-----	-----	-----	----	-----

Restore

F	04	05	42	00	F1	000000	3C	CR	F	44	05	42	00	F1	000000	7C	CR
---	----	----	----	----	----	--------	----	----	---	----	----	----	----	----	--------	----	----

Run macro 1

F	04	00	42	00	F1	000000	37	CR	F	44	00	42	00	F1	000000	77	CR
---	----	----	----	----	----	--------	----	----	---	----	----	----	----	----	--------	----	----

Run macro 2

F	04	01	42	00	F1	000000	38	CR	F	44	01	42	00	F1	000000	78	CR
---	----	----	----	----	----	--------	----	----	---	----	----	----	----	----	--------	----	----

Run macro 3

F	04	02	42	00	F1	000000	39	CR	F	44	02	42	00	F1	000000	79	CR
---	----	----	----	----	----	--------	----	----	---	----	----	----	----	----	--------	----	----

Run macro 7

F	04	07	42	00	F1	000000	39	3E	F	44	02	42	00	F1	000000	7E	CR
---	----	----	----	----	----	--------	----	----	---	----	----	----	----	----	--------	----	----

Emulate a front panel button press

This is performed using function code 0x24F and the following payload codes (requires firmware version 287 onwards). Note that not all button presses are relevant to your unit.

Button press	Payload
Power down	0400E1
Power back on – see Reset command.	N/A
Reset menu settings to power-on values	0100E2
Reset menu settings to factory defaults	2300E2
Lock / unlock front panel buttons	0100E3
Set to NTSC output	0000E7
Set to PAL output	0000E8
Set to default output resolution for unit	0000E9
Set to 480p output	0000EA
Set to 720p 59.94Hz output	0000EB
Set to 720p 60Hz output	0000EC
Cycle presets (demo mode)	0100EE
Select DVI-I1 as source	000200
Select DVI-I2 as source	000201
Select DVI-I3 as source	000202
Select DVI-I4 as source	0002A2
Select CV1 as source	000203
Select CV2 as source	000204
Select CV3 as source	000205
Select YC1 as source	000206
Select YC2 as source	000207
Select YC3 as source	000208
Select SD1 as source	00022B
Select SD2 as source	00022C
Select SD3 as source	0002A4
Select SD4 as source	0002A5
Select TC1 / SIS1 as source	000209
Select TC2 / SIS2 as source	00020A
Select OUT1 as source	00020B

Button press	Payload
Select OUT2 as source	00020C
Toggle window A/B/Z	00020D
Toggle output 1/2	00020E
TAKE (activate transition)	00020F
FREEZE	000211
KEY	000212
MIX	00024D
INPUT	00024E
AUTOSET	00024F
FADE	000251
ZOOM	000252
PAN	000253
SIZE	000254
POS	000255
LOCK	000256
PIP	000257
MIX / PIP	00025A
ASPECT	00025D
PAN / POS	00026F
ZOOM	000270
LOCK / MIX	000269
Decrease Shrink value	000213
Increase Shrink value	000214
Decrease Zoom value	000215
Increase Zoom value	000216
Reset settings to power-on values	000217
Identify current window	000218
Run Macro 1	000219
Run Macro 2	00021A
Run Macro 3	00021B
Run Macro 4	00021C
Run Macro 5	00021D
Run Macro 6	000267
Run Macro 7	000268

Button press	Payload
Add to Macro 1	020119
Add to Macro 2	02011A
Add to Macro 3	02011B
Add to Macro 4	02011C
Add to Macro 5	02011D
Add to Macro 6	020167
Add to Macro 7	020168
Erase Macro 1	280119
Erase Macro 2	28011A
Erase Macro 3	28011B
Erase Macro 4	28011C
Erase Macro 5	28011D
Erase Macro 6	280167
Erase Macro 7	280168
Decrease Horizontal Pan value	00021E
Increase Horizontal Pan value	00021F
Decrease Vertical Pan value	000220
Increase Vertical Pan value	000221
Select window A	000223
Select window B	000224
Select window C	0002A0
Select window D	0002A1
Select window Z	000225
Select Output 1	000226
Select Output 2	000227
SELECT (menu adjust)	000128
Left rotary (menu adjust rotary control)	000129
Right rotary (menu adjust rotary control)	00012A
Left (menu adjust)	000158
Right (menu adjust)	000159
Decrement / ZOOM (menu adjust)	00024B
Increment / FREEZE (menu adjust)	00024C
Decrement / PIP (menu adjust)	00029E
Increment / KEY (menu adjust)	00029F

Button press	Payload
Set transition to FADE	00026A
Set transition to WIPE	00026B
Set transition to PUSH	00026C
Select DVI1 as source for window A	00023C
Select DVI2 as source for window A	00023D
Select DVI3 as source for window A	00023E
Select DVI4 as source for window A	0002A7
Select DVI5 as source for window A	0002A8
Select DVI6 as source for window A	0002A9
Select DVI7 as source for window A	0002AA
Select DVI8 as source for window A	0002AB
Select DVI9 as source for window A	0002AC
Select DVI10 as source for window A	0002AD
Select DVI11 as source for window A	0002AE
Select DVI12 as source for window A	0002AF
Select CV1 as source for window A	00023F
Select CV2 as source for window A	000240
Select CV3 as source for window A	000241
Select YC1 as source for window A	000242
Select YC2 as source for window A	000243
Select YC3 as source for window A	000244
Select TC1 as source for window A	000245
Select TC2 as source for window A	000246
Select TC3 as source for window A	0002B9
Select OUT1 as source for window A	000247
Select OUT2 as source for window A	000248
Select SDI1 as source for window A	000249
Select SDI2 as source for window A	00024A
Select SDI3 as source for window A	000271
Select SDI4 as source for window A	000272
Select SDI5 as source for window A	000273
Select SDI6 as source for window A	000274
Select SDI7 as source for window A	000275
Select SDI8 as source for window A	000276

Button press	Payload
Select DVI1 as source for window B	00022D
Select DVI2 as source for window B	00022E
Select DVI3 as source for window B	00022F
Select DVI4 as source for window B	0002B0
Select DVI5 as source for window B	0002B1
Select DVI6 as source for window B	0002B2
Select DVI7 as source for window B	0002B3
Select DVI8 as source for window B	0002B4
Select DVI9 as source for window B	0002B5
Select DVI10 as source for window B	0002B6
Select DVI11 as source for window B	0002B7
Select DVI12 as source for window B	0002B8
Select CV1 as source for window B	000230
Select CV2 as source for window B	000231
Select CV3 as source for window B	000232
Select YC1 as source for window B	000233
Select YC2 as source for window B	000234
Select YC3 as source for window B	000235
Select TC1 as source for window B	000236
Select TC2 as source for window B	000237
Select TC3 as source for window B	0002BA
Select OUT1 as source for window B	000238
Select OUT2 as source for window B	000239
Select SDI1 as source for window B	00023A
Select SDI2 as source for window B	00023B
Select SDI3 as source for window B	000277
Select SDI4 as source for window B	000278
Select SDI5 as source for window B	000279
Select SDI6 as source for window B	00027A
Select SDI7 as source for window B	00027B
Select SDI8 as source for window B	00027C
Lock to CV1	00025B
Lock to YC1	00025C
Toggle CV1 / YC1 as source	00025E

Button press	Payload
Toggle CV2 / YC2 as source	00025F
Toggle DVI-D1 / SDI1 as source	000260
Toggle RGB1 / YUV1 as source	000261
Select DVI-D1 as source	000262
Select RGB1 as source	000263
Select RGB2 as source	00027D
Select YUV1 as source	000264
Logo 1A toggle on/off	000265
Logo 2B toggle on/off	000266
Window 1A toggle on/off	00026D
Window 2B toggle on/off	00026E
Go to Lock menu item	00027E
Output 1 toggle on/off	00027F
Output 2 toggle on/off	000280
Select UNI1 as source for window A	000281
Select UNI2 as source for window A	000282
Select UNI3 as source for window A	000283
Select UNI4 as source for window A	000284
Select UNI5 as source for window A	000285
Select UNI6 as source for window A	000286
Select UNI7 as source for window A	000287
Select UNI8 as source for window A	000288
Select UNI1 as source for window B	000289
Select UNI2 as source for window B	00028A
Select UNI3 as source for window B	00028B
Select UNI4 as source for window B	00028C
Select UNI5 as source for window B	00028D
Select UNI6 as source for window B	00028E
Select UNI7 as source for window B	00028F
Select UNI8 as source for window B	000290
Load Preset 1	000291
Load Preset 2	000292
Load Preset 3	000293
Load Preset 4	000294

Button press	Payload
Load Preset 5	000295
Load Preset 6	000296
Load Preset 7	000297
Load Preset 8	000298
Load Preset 9	000299
Load Preset 10	00029A
Store Preset 1	020191
Store Preset 2	020192
Store Preset 3	020193
Store Preset 4	020194
Store Preset 5	020195
Store Preset 6	020196
Store Preset 7	020197
Store Preset 8	020198
Store Preset 9	020199
Store Preset 10	02019A
Erase Preset 1	280191
Erase Preset 2	280192
Erase Preset 3	280193
Erase Preset 4	280194
Erase Preset 5	280195
Erase Preset 6	280196
Erase Preset 7	280197
Erase Preset 8	280198
Erase Preset 9	280199
Erase Preset 10	28019A
Set output to BLACK	00029B
Set output to WHITE	00029C
Toggle edge blend lines on/off	00029D
Cycle scaler inputs	0002A3

I.e. insert the 6 digit code from above into the following text string:

F041041024F#####??<CR>

E.g. to Load Preset 1, use the text string:

F041041024F000291??<CR>

Reset command

MNL-8xxx-V2.20

This is a special command to reset a unit (as if power had been removed and re-applied). Note that unlike the above commands, this is sent as binary (i.e. not as ASCII text).

0x53, 0x06, 0x04, 0x01, 0x55, 0xAA, 0x55, 0xB2

E.g. In Visual Basic, send the string:

Chr\$(&H53) + Chr\$(&H6) + Chr\$(&H4) + Chr\$(&H1) + Chr\$(&H55) + Chr\$(&HAA) + Chr\$(&H55) + Chr\$(&HB2)

Common operations

This section provides step by step instructions for some common operations.

Operation of the keyer

Some units come equipped with a very powerful Luminance and Chrominance Keyer. The Keyer can take some time to master and below is a breakdown and series of simple steps to help you master the Keyer's operation

When adjusting the values, please bear in the mind the following:

The Y value is the Luminance value, so 0 is black and 255 is very bright (white).

The U value is the B-Y component. This is the difference between the Blue and the Luminance value. If part of an image is black, grey or white, then its value is 128 (being the mid-point).

The V value is the R-Y component. This is the difference between the Red and the Luminance value. If part of an image is black, grey or white, then its value is 128 (being the mid-point).

Preparation:

1. Enter the Adjust windows menu.
2. Select the Source (this will be the foreground).
3. Exit the Adjust windows menu.
4. Enter the Adjust keyers menu.
5. Ensure the Keyer is Off.
6. Set all Y, U and V min/max values to [0] [255].
7. Set all Y, U and V softness values to 0.
8. Set all Y, U and V invert values to Off.
9. Turn the Keyer On.

At this point your source image will have disappeared, since all colors have been keyed out.

Adjustment:

Knowing which color(s) you want to key out from the image, e.g. black to disappear, perform the following set of steps:

1. Increase the Y Key Min from 0 until just before the required color (Key Color) appears.
2. Decrease the Y Key Max from 255 until just before the required color (Key Color) appears.
3. Repeat steps 1 & 2 for the U and V min/max values as well.

Adjust any of the Softness values to improve the key. If your input signal is slightly noisy or if you want to soften the edges within the image, then this may require you to decrease the 'min' values and increase the 'max' values to broaden the range of colors keyed out.

At this point, only the key color should remain transparent.

Troubleshooting and FAQs

There is no picture on the Output.

If no LEDs are on, then ensure that the AC power adaptor is connected properly and the power switch is on at the AC outlet.

If the Standby/ON LED on the unit is off but another blue LED is active then check that the monitor output from the computer is connected at both the computer and the unit. Check that the output connector you are using from the unit is also connected at the unit and the display equipment.

Check that the display video equipment is set to the correct line input and format/standard as appropriate.

Check that the device connected to the output is on and can support the resolution set in the Adjust output menu, ensuring that the Sync type e.g. RGBHV, is also set correctly.

The image is shifted and not fully viewable

There are several ways to correct this, depending on the actual problem, although it's generally best to perform a Factory reset.

Try an AUTOSET if the input is RGB or YUV/YCbCr. Next adjust the TL pos. adj. values in the Setup Program source menu until the incoming video signal is displayed correctly. You may also need to adjust the BR size adj. setting to ensure the incoming video signal is properly displayed.

The output resolutions no longer appear as expected.

Because any changes made in the Adjust resolutions menu are automatically stored, it may be that the resolution data has become altered or corrupted beyond the ability of a display to show it.

Either manually correct the resolution data, or restore the data to full factory conditions by doing a firmware update. The user should avoid altering the resolution parameter data unless absolutely necessary.

There is excessive flicker on the Output.

Try using a different Flicker reduction mode. Turning the contrast down and the brightness up on the output device can have a large effect on flicker. Or try adjusting the brightness and contrast of the source input by selecting the Input adjust menu.

The Output image is distorted.

This may occur where some of the areas of the image are very dark and others are very bright. The solution is to adjust the contrast and brightness settings on your Output device to rectify the problem.

Alternatively, if the Adjust resolutions menu has been used to the output resolution in question, a firmware update is recommended to perform a FULL factory reset.

Some colors appear to be incorrect on the CV/YC output

First try altering the color, contrast and brightness settings on your TV or video display. These are usually set up for a very different reason than viewing computer graphics and may need changing to suit. If you cannot achieve exactly what you desire then alter the inputs levels in Adjust sources until the correct colors are restored.

How can I reduce color smearing on CV connections?

Smearing usually occurs on Composite Video connections and is generally unavoidable - unless you can switch to using S-Video or RGB / YUV connections. It occurs because the brightness and color information is transmitted as one combined (composite) signal and the two parts have to be 'bandwidth-limited' to avoid them interfering with each other - which then reduces the quality.

I can no longer adjust the Output image resolution.

When the unit is in Lock mode, the output resolution is fixed to be the same as the Lock source input resolution. During this time the Output image menu item is not displayed.

The picture on the video display is black and white.

Ensure that all the cables are correctly connected. If you are using a PAL TV to display the output then the unit may be providing resolution set to NTSC mode, or vice versa.

The picture on the video display is green.

The Output type is probably incorrectly set to YUV mode, whereas you are connecting to an RGB monitor – see Adjust outputs menu.

The RGB input is selected but the image is rolling or pink.

Check the Adjust sources menu and confirm that the input type and sync method is set correctly. (Having YUV input selected, instead of RGBHV often causes this problem).

The video signal from my DVD player does not appear to work.

Some DVD players have a switch at the back that selects between 'Component' and 'S-Video' output, because most will not let you output both at the same time. Make sure it is in the right position for the output you want.

Image is flashing, snow is present, or source image does not appear.

You may be experiencing a HDCP compatibility problem.

If one of the sources you are using is HDCP encrypted, and your unit is not set to output HDCP, then your unit will not allow the source image to pass through the unit (it may flash on and off).

The solution (if your unit supports HDCP) is to ensure it is enabled in both 'Adjust outputs' and in the 'Adjust sources' menu for that source signal.

If your unit does not support HDCP, or your output device does not support HDCP (e.g. an analog monitor), then there is no way to display a HDCP encrypted source signal.

General troubleshooting checklist

If specific troubleshooting advice isn't helping, or your product has stopped working, go through the points below. If your product still doesn't work, you might need to return it for repair.

1. Make sure your product is set up correctly, as shown in this guide.
2. Check that your cables and equipment are all connected firmly.
3. Check that your product is connected to an electrical outlet that is switched on.

Can you see LED lights on the front of your product?

4. Test your sources by connecting them directly to a display.
5. Test your display by connecting it directly to a source.
6. Test each cable.
7. Try restoring your product to factory default settings.

Note: during factory reset your custom settings are deleted.

8. Try updating your firmware.

Note: during a firmware update your custom settings are deleted.

Returning a product for repair

You can request to return your product to tvONE™ for repair. When you contact tvONE support, have the following information ready.

- Product type
- Serial number of the faulty unit (this is on the underside of the unit)
- Full details of the issue
- Invoice number (if available)

Contact tvONE support for your area.

- Customers in North, Central, and South America (NCSA), email tech.usa@tvone.com.
- Customers in Europe, the Middle East, and Africa (EMEA), email tech.europe@tvone.com.
- Customers in Asia, email tech.asia@tvone.com.

EMEA and Asia

Customers in EMEA and Asia receive an RMA Request form from tvONE support. Complete the form and return it to tvONE support for your area.

All customers

tvONE support decides if your product needs to return for repair, and, if needed, provide a return authorization number.

Send your product to tvONE by insured carrier or registered mail. Write your return authorization number on the outside of the packaging, and on any documents you send with your product.

You must arrange and pay for shipping and insurance. Products in transit are your responsibility. tvONE does not accept responsibility for products lost in transit.

Do not return a product for warranty repair without a return authorization number. tvONE will not repair your product.

Specifications

Video inputs

Connection: CV, YC on DVI-I connector

Input impedance: 75 Ohm

Television standards supported: NTSC, PAL and SECAM

CV/YC video decoder: 10-bit Digital

De-Interlacing (up-conversion only): pixel-level motion adaptive with noise reduction

Comb filter decoding: adaptive

Film mode (NTSC) 3:2 pull down for up-conversion

CV/YC Video adjustments: contrast, brightness, saturation, hue (NTSC)

Reference input

Connection: CV or Tri-level HD (720p, 1080i, 1080p) on BNC

CV/YC sub-carrier lock range: +/- 200Hz for NTSC Operation, +/- 250Hz for PAL Operation

Computer digital inputs

Connection: DVI-D (on DVI-I connector) supporting up to 162MHz / 1920x1200 @ 60Hz.

Supports HDCP repeater functionality.

EDID 1.3 data on DVI-D connector to communicate available resolutions.

Compatible with HDMI sources (change EDID setting in Adjust sources).

Supports 48kHz audio input when HDMI input active.

Analog inputs

Connection: RGBHV / YPbPr on DVI-I connector

Analog RGB/YPbPr supporting RGBHV, RGBS, RGsB, YPbPr terminating into 75 Ohm

Digital sync (in RGBHV or RGBS mode): TTL Level, 10K termination, pos or negative

Analog sync (in RGsB, YPbPr, YUV modes): 0.3v negative.

Analog RGB Level Range: 0.5-2.0 Vp-p approx.

De-Interlacing (YUV/YPbPr only): pixel-level motion adaptive with noise reduction

Scan Rate Detection: automatic

Analog PC Resolutions: any up to 2048x2048

Analog HDTV Resolutions: any up to 1080p

Analog max horizontal scan rate: 150kHz

Video outputs

Connection: CV, YC on DVI-I connector

Output impedance 75 Ohm

Television standards supported: NTSC and PAL

Composite Video 1v p-p

S-Video (YC) 1v p-p

Computer digital outputs

Connection: DVI-D on DVI-I connector, supporting up to 162MHz / 1920x1200 @ 60Hz.

Supports HDCP repeater functionality.

Can output HDMI-compatible signal with audio @ 48kHz.

Analog outputs

Connection: RGBHV / YPbPr on DVI-I connector

Analog output impedance 75 Ohm

Analog RGBHV, RGBS, RGsB, YPbPr (0.7v RGB / 1.0v sync-tip to white)

Analog PC Resolutions: any up to 2048x2048 (user adjustable)

Analog HDTV Resolutions: any up to 1080p

Vertical Refresh Rate: any to 250Hz

SDI inputs and outputs

Compliant with SDI, HD-SDI and 3G-SDI.

SDI-SDI: SMPTE 259M-C (Jitter <0.10UI)

HD-SDI: SMPTE 292M (Jitter <0.20UI)

3G-SDI: SMPTE 425M-A (Jitter <0.30UI)

4x Stereo audio @ 48kHz can be de-embedded and embedded on each SDI connection

Audio module

Provides 8x AES3-id inputs and 8x AES3-id outputs (1v peak-peak)

Allows connection of A2-7300 range of analog to digital and digital to analog convertors

Locking/Mixing

Unit can be locked to the Reference, DVI-U1 and DVI-U2 inputs only

Keyer: chromakey (YUV) or lumakey (Y)

Mixer: Can mix any combination of layers in any order – depending on Mode in use

PIP: variable window size and position – single-button enabling

Scaling / sampling / memory

Size and position: automatic via AutoSet or Manual

Image size: user-definable presets

Image freeze: one video frame

Settings memory: non-Volatile

Zoom range: variable to 10x Zoom (1000%)

Shrink range: variable to 10%

Image mirroring: Horizontal and/or Vertical

Horizontal filtering: full digital

De-interlacing: Motion pixel adaptive with noise reduction

Frame-rate conversion: frame add / drop (double-buffered)

Conversion technology: proprietary CORIO2

Color resolution: 24-bit (16.8 Million Colors)

Max sampling rate: 162MHz maximum

Digital sampling: RGB 24-bit 4:4:4 format, YUV 20-bit 4:2:2 format

Firmware memory: flash, upgradeable via RS-232

Reliability

MTBF has been calculated to be 30,000+ hours

Regulatory Compliance

Main unit conforms to FCC, CE, RoHS. PSU is UL marked.

Environmental

Operating Temperature 0° to +50° C (+32° to +122° F)

Operating Humidity 10% to 85%, Non-condensing
Storage Temperature -10° to +70° C (+14° to +158° F)
Storage Humidity 10% to 85%, Non-condensing

Power Requirement

Power inlet: Auto-sensing 110v / 230v AC.
(Optional factory-fitted redundant PSU from single inlet.)

Control Methods

The unit can be controlled locally via the front panel buttons, multi-directional switch and Liquid Crystal Display. It can also be controlled remotely via the RS-232 interface using a D9 female connector or again remotely using Ethernet via a RJ45 Ethernet connector.

Accessories Included

Varies depending on unit.

Mechanical

Enclosure size (H x W x D): 1.73" x 17.0" x 13.1" (44 x 431 x 334mm)
Weight (Net): 10.6 lbs+ (4.82 kg+) depending on unit.

Contact us

tvone.com

info@tvone.com

Support NCSA: tech.usa@tvone.com

Support EMEA: tech.europe@tvone.com

Support Asia: tech.asia@tvone.com

Information in this document is subject to change without notice. No part of this publication may be reproduced, stored in a retrieval system, or transmitted in any form or any means electronic or mechanical, including photocopying and recording for any purpose other than the purchaser's personal use without the written permission of tvONE.

Copyright © 2019 tvONE™. All rights reserved.

Registered in the U.S. Patent and Trademark Office.