

4K / UHD Scaler for HDBaseT™ and HDMI



Version Information

Version	Release Date	Notes
1	10/18	Initial release

Welcome to Atlona!

Thank you for purchasing this Atlona product. We hope you enjoy it and will take an extra few moments to register your new purchase.

Registration only takes a few minutes and protects this product against theft or loss. In addition, you will receive notifications of product updates and firmware. Atlona product registration is voluntary and failure to register will not affect the product warranty.

To register your product, go to <http://www.atlona.com/registration>

Sales, Marketing, and Customer Support

Main Office

Atlona Incorporated
70 Daggett Drive
San Jose, CA 95134
United States

Office: +1.877.536.3976 (US Toll-free)
Office: +1.408.962.0515 (US/International)

Sales and Customer Service Hours
Monday - Friday: 6:00 a.m. - 4:30 p.m. (PST)

<http://www.atlona.com/>

International Headquarters

Atlona International AG
Ringstrasse 15a
8600 Dübendorf
Switzerland

Office: +41 43 508 4321

Sales and Customer Service Hours
Monday - Friday: 09:00 - 17:00 (UTC +1)

Operating Notes



IMPORTANT: Visit <http://www.atlona.com/product/AT-HDVS-SC-RX> for the latest firmware updates and User Manual.

Atlona, Inc. (“Atlona”) Limited Product Warranty

Coverage

Atlona warrants its products will substantially perform to their published specifications and will be free from defects in materials and workmanship under normal use, conditions and service.

Under its Limited Product Warranty, Atlona, at its sole discretion, will either:

- repair or facilitate the repair of defective products within a reasonable period of time, restore products to their proper operating condition and return defective products free of any charge for necessary parts, labor and shipping.

OR

- replace and return, free of charge, any defective products with direct replacement or with similar products deemed by Atlona to perform substantially the same function as the original products.

OR

- refund the pro-rated value based on the remaining term of the warranty period, not to exceed MSRP, in cases where products are beyond repair and/or no direct or substantially similar replacement products exist.

Repair, replacement or refund of Atlona products is the purchaser’s exclusive remedy and Atlona liability does not extend to any other damages, incidental, consequential or otherwise.

This Limited Product Warranty extends to the original end-user purchaser of Atlona products and is non-transferrable to any subsequent purchaser(s) or owner(s) of these products.

Coverage Periods

Atlona Limited Product Warranty Period begins on the date of purchase by the end-purchaser. The date contained on the end-purchaser’s sales or delivery receipt is the proof purchase date.

Limited Product Warranty Terms – New Products

- 10 years from proof of purchase date for hardware/electronics products purchased on or after June 1, 2013.
- 3 years from proof of purchase date for hardware/electronics products purchased before June 1, 2013.
- Lifetime Limited Product Warranty for all cable products.

Limited Product Warranty Terms – Refurbished (B-Stock) Products and Discontinued Products

- 3 years from proof of purchase date for all Refurbished (B-Stock) and Discontinued hardware and electronic products purchased on or after June 1, 2013.

Remedy

Atlona recommends that end-purchasers contact their authorized Atlona dealer or reseller from whom they purchased their products. Atlona can also be contacted directly. Visit atlona.com for Atlona’s contact information and hours of operation. Atlona requires that a dated sales or delivery receipt from an authorized dealer, reseller or end-purchaser is provided before Atlona extends its warranty services. Additionally, a return merchandise authorization (RMA) and/or case number, is required to be obtained from Atlona in advance of returns.

Atlona requires that products returned are properly packed, preferably in the original carton, for shipping. Cartons not bearing a return authorization or case number will be refused. Atlona, at its sole discretion, reserves the right to reject any products received without advanced authorization. Authorizations can be requested by calling 1-877-536-3976 (US toll free) or 1-408- 962-0515 (US/international) or via Atlona’s website at atlona.com.

Exclusions

This Limited Product Warranty excludes:

- Damage, deterioration or malfunction caused by any alteration, modification, improper use, neglect, improper packaging or shipping (such claims must be presented to the carrier), lightning, power surges, or other acts of nature.

Atlona, Inc. (“Atlona”) Limited Product Warranty

- Damage, deterioration or malfunction resulting from the installation or removal of this product from any installation, any unauthorized tampering with this product, any repairs attempted by anyone unauthorized by Atlona to make such repairs, or any other cause which does not relate directly to a defect in materials and/or workmanship of this product.
- Equipment enclosures, cables, power supplies, batteries, LCD displays, and any accessories used in conjunction with the product(s).
- Products purchased from unauthorized distributors, dealers, resellers, auction websites and similar unauthorized channels of distribution.

Disclaimers

This Limited Product Warranty does not imply that the electronic components contained within Atlona’s products will not become obsolete nor does it imply Atlona products or their electronic components will remain compatible with any other current product, technology or any future products or technologies in which Atlona’s products may be used in conjunction with. Atlona, at its sole discretion, reserves the right not to extend its warranty offering in instances arising outside its normal course of business including, but not limited to, damage inflicted to its products from acts of god.

Limitation on Liability

The maximum liability of Atlona under this limited product warranty shall not exceed the original Atlona MSRP for its products. To the maximum extent permitted by law, Atlona is not responsible for the direct, special, incidental or consequential damages resulting from any breach of warranty or condition, or under any other legal theory. Some countries, districts or states do not allow the exclusion or limitation of relief, special, incidental, consequential or indirect damages, or the limitation of liability to specified amounts, so the above limitations or exclusions may not apply to you.

Exclusive Remedy

To the maximum extent permitted by law, this limited product warranty and the remedies set forth above are exclusive and in lieu of all other warranties, remedies and conditions, whether oral or written, express or implied. To the maximum extent permitted by law, Atlona specifically disclaims all implied warranties, including, without limitation, warranties of merchantability and fitness for a particular purpose. If Atlona cannot lawfully disclaim or exclude implied warranties under applicable law, then all implied warranties covering its products including warranties of merchantability and fitness for a particular purpose, shall provide to its products under applicable law. If any product to which this limited warranty applies is a “Consumer Product” under the Magnuson-Moss Warranty Act (15 U.S.C.A. §2301, ET SEQ.) or other applicable law, the foregoing disclaimer of implied warranties shall not apply, and all implied warranties on its products, including warranties of merchantability and fitness for the particular purpose, shall apply as provided under applicable law.

Other Conditions

Atlona’s Limited Product Warranty offering gives legal rights, and other rights may apply and vary from country to country or state to state. This limited warranty is void if (i) the label bearing the serial number of products have been removed or defaced, (ii) products are not purchased from an authorized Atlona dealer or reseller. A comprehensive list of Atlona’s authorized distributors, dealers and resellers can be found at www.atlona.com.

Safety and Certification

CAUTION
 RISK OF ELECTRIC SHOCK
 DO NOT OPEN

CAUTION: TO REDUCE THE RISK OF
 ELECTRIC SHOCK
 DO NOT OPEN ENCLOSURE OR EXPOSE
 TO RAIN OR MOISTURE.
 NO USER-SERVICEABLE PARTS
 INSIDE REFER SERVICING TO
 QUALIFIED SERVICE PERSONNEL.



The exclamation point within an equilateral triangle is intended to alert the user to the presence of important operating and maintenance instructions in the literature accompanying the product.



The information bubble is intended to alert the user to helpful or optional operational instructions in the literature accompanying the product.

1. Read these instructions.
2. Keep these instructions.
3. Heed all warnings.
4. Follow all instructions.
5. Do not use this product near water.
6. Clean only with a dry cloth.
7. Do not block any ventilation openings. Install in accordance with the manufacturer's instructions.
8. Do not install or place this product near any heat sources such as radiators, heat registers, stoves, or other apparatus (including amplifiers) that produce heat.
9. Do not defeat the safety purpose of a polarized or grounding-type plug. A polarized plug has two blades with one wider than the other. A grounding type plug has two blades and a third grounding prong. The wide blade or the third prong are provided for your safety. If the provided plug does not fit into your outlet, consult an electrician for replacement of the obsolete outlet.
10. Protect the power cord from being walked on or pinched particularly at plugs, convenience receptacles, and the point where they exit from the product.
11. Only use attachments/accessories specified by Atlona.
12. To reduce the risk of electric shock and/or damage to this product, never handle or touch this unit or power cord if your hands are wet or damp. Do not expose this product to rain or moisture.
13. Unplug this product during lightning storms or when unused for long periods of time.
14. Refer all servicing to qualified service personnel. Servicing is required when the product has been damaged in any way, such as power-supply cord or plug is damaged, liquid has been spilled or objects have fallen into the product, the product has been exposed to rain or moisture, does not operate normally, or has been dropped.



FCC Statement

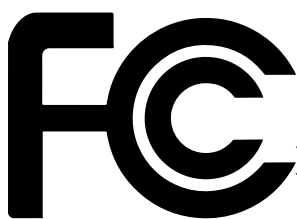

FCC Compliance and Advisory Statement: This hardware device complies with Part 15 of the FCC rules. Operation is subject to the following two conditions: 1) this device may not cause harmful interference, and 2) this device must accept any interference received including interference that may cause undesired operation. This equipment has been tested and found to comply with the limits for a Class A digital device, pursuant to Part 15 of the FCC Rules.

These limits are designed to provide reasonable protection against harmful interference in a commercial installation. This equipment generates, uses, and can radiate radio frequency energy and, if not installed or used in accordance with the instructions, may cause harmful interference to radio communications. However there is no guarantee that interference will not occur in a particular installation. If this equipment does cause harmful interference to radio or television reception, which can be determined by turning the equipment off and on, the user is encouraged to try to correct the interference by one or more of the following measures: 1) reorient or relocate the receiving antenna; 2) increase the separation between the equipment and the receiver; 3) connect the equipment to an outlet on a circuit different from that to which the receiver is connected; 4) consult the dealer or an experienced radio/TV technician for help. Any changes or modifications not expressly approved by the party responsible for compliance could void the user's authority to operate the equipment. Where shielded interface cables have been provided with the product or specified additional components or accessories elsewhere defined to be used with the installation of the product, they must be used in order to ensure compliance with FCC regulations.



The terms HDMI, HDMI High-Definition Multimedia Interface, and the HDMI Logo are trademarks or registered trademarks of HDMI licensing Administrator, Inc.

Table of Contents

Introduction	8
Features	8
Package Contents	8
Panel Description	9
Installation	10
RS-232 Connector	10
Analog Audio Connector	10
Relay Connector	11
Connection Instructions	12
Connection Diagrams	13
IP Configuration	14
Using the OSD	14
Setting the IP Address Using Commands	15
Setting the IP Address using the Web GUI	16
Basic Operation	17
Managing Users	17
Adding Users	17
Editing / Deleting Users	18
The Web GUI	19
Accessing the Web GUI	19
Info page	20
Video page	21
Audio page	24
Display page	25
RS-232 page	29
Config page	31
System page	32
Updating the Firmware	34
Using the Web GUI	34
Using USB	36
Default Settings	37
Specifications	38
Index	40

Introduction

The Atlona **AT-HDVS-SC-RX** is an HDBaseT receiver and 4K/UHD scaler with a local HDMI input. It receives HDBaseT for video output up to 4K/30 4:4:4, plus embedded audio, control, and Ethernet over distances up to 330 feet (100 meters). The HDVS-SC-RX features Atlona CrystalScale technology with high-quality downscaling and upscaling, as well as advanced image optimization capabilities plus internal test patterns for setup and troubleshooting. The HDVS-SC-RX is ideal for 4K presentation applications with HDVS-200 and Omega™ Series switching transmitters, EX Series transmitters, Atlona AV switchers with HDBaseT outputs, and local HDMI sources, and the Gain™ 60 amplifier. The HDVS-SC-RX and HDVS-200 or Omega Series transmitter together serve as a compact, fully automated AV system with the convenience of automatic input selection, display control, remote transmitter powering through Power over Ethernet (PoE), and 4K/UHD scaling.

Features

- HDBaseT™ receiver with local HDMI® input
- Advanced 4K/UHD scaling featuring all-new, Atlona CrystalScale™ technology
- Pristine-quality downscaling and upscaling
- Aspect ratio control
- Image optimization for flat-panel and LED tiled displays
- Advanced motion-adaptive deinterlacing for 1080i input signals
- Exclusive image-optimization features for flat panel and LED tiled displays
- Internal video test patterns for setup, calibration, and troubleshooting
- Automatic input selection and automatic display control using IP, RS-232, or CEC
- Contact closure for screen or display lift control
- Audio de-embedding

Package Contents

- 1 x AT-HDVS-SC-RX
- 1 x Captive screw connector, 2-pin
- 1 x Captive screw connector, 3-pin
- 2 x Captive screw connectors, 5-pin
- 1 x 24 V DC power supply
- 1 x Installation Guide

Panel Description

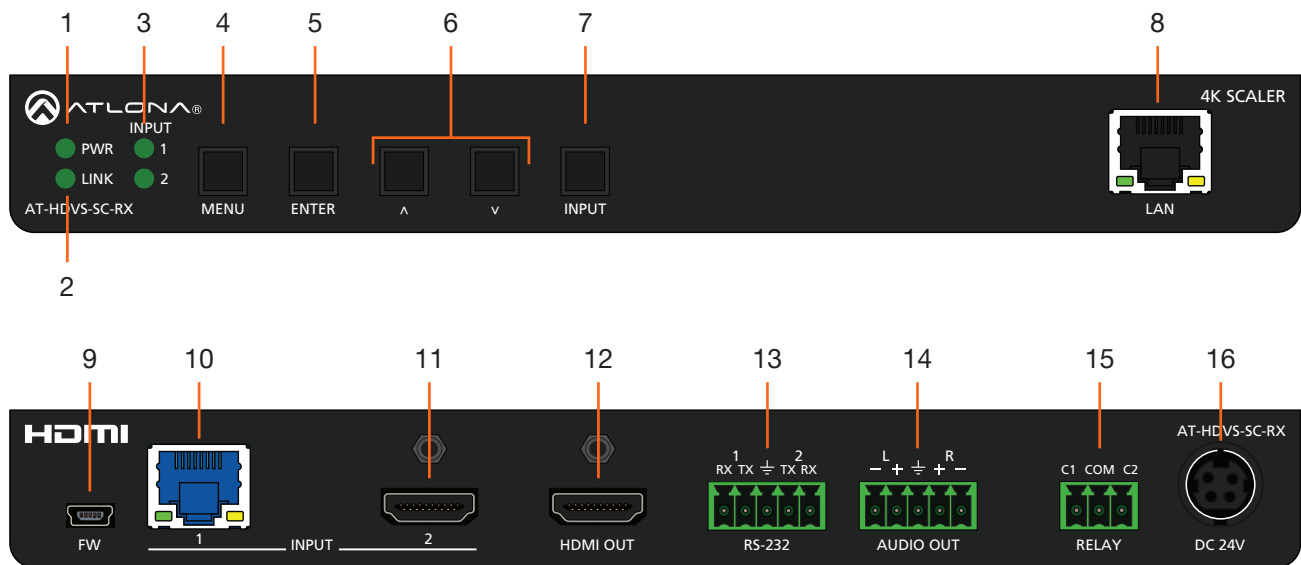

1 PWR

This LED indicator glows solid green when the unit is powered. When set to standby mode, this LED indicator glows solid amber.

2 LINK

This LED indicator displays the link status.

3 INPUT 1 / 2

These LED indicators display the currently selected input. The active input will be indicated by a solid green LED.

4 MENU

Press this button to display the built-in menu system.

5 ENTER

Press this button to confirm the highlighted selection in the menu system.

6 UP / DOWN

Press these buttons to highlight the desired options in the menu system.

7 INPUT

Press and release this button to toggle between **INPUT 1** and **INPUT 2** ports. The **INPUT 1** and **INPUT 2** LED indicators will toggle, based on the selected input.

8 LAN

Connect an Ethernet cable from this port to the Local Area Network.

9 FW

Connect a mini USB cable to this port to update the firmware.

10 HDBaseT Input

Connect an HDBaseT transmitter, such as the AT-HDVS-210-TX or AT-UHD-CLSO-840, to this port using an Ethernet cable.

11 HDMI Input

Connect a UHD/HD source to this port using an HDMI cable.

12 HDMI OUT

Connect an HDMI cable from this port to a display or other sink device.

13 RS-232

Connect to a control system such as Atlona Velocity™.

14 AUDIO OUT

Connect the included 5-pin captive screw connector to this port. Use the included 5-pin captive screw block to connect to an audio amplifier, such as an AT-GAIN-60. Refer to [Analog Audio Connector \(page 10\)](#) for wiring information.

15 RELAY

Connect one of the included 3-pin captive screw connectors to this port to control screens, drapes, lights, or other devices. Refer to [Relay Connector \(page 11\)](#) for wiring information.

16 DC 24V

Connect the included 24 V DC locking power supply to this power receptacle.

Installation

RS-232 Connector

The AT-HDVS-SC-RX provides RS-232 control between an automation system and an RS-232 device or display control. **RS-232 1** is for display control and **RS-232 2** is used to control the AT-HDVS-SC-RX. This step is optional.

1. Use wire strippers to remove a portion of the cable jacket.
2. Remove at least 3/16" (5 mm) from the insulation of the RX, TX, and GND wires.
3. Insert the TX, RX, and GND wires into correct terminal on the included captive screw connector.

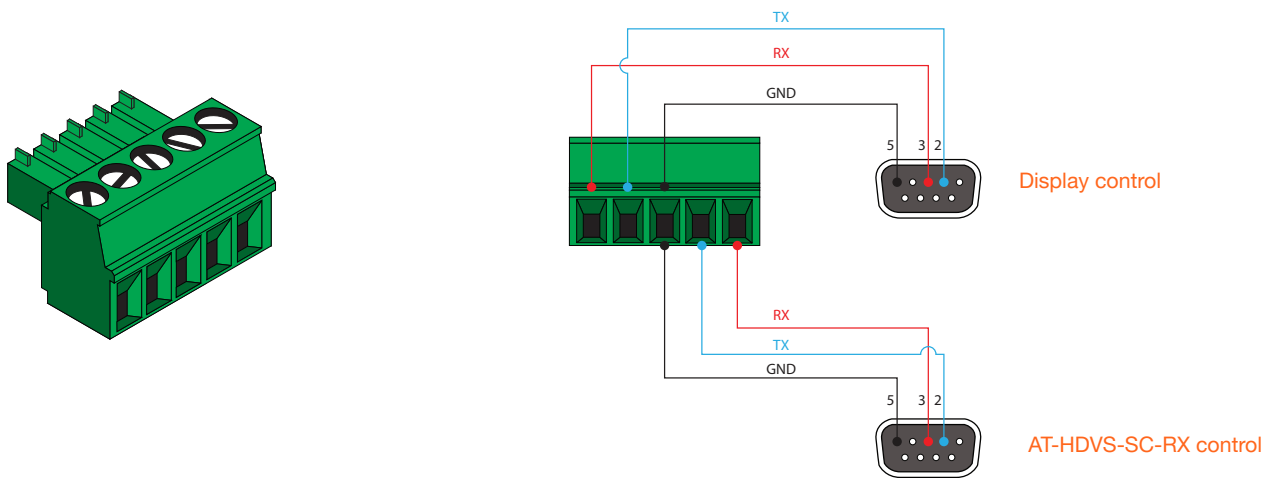

Analog Audio Connector

The **AUDIO OUT** connector on the AT-HDVS-SC-RX provides de-embedded line-level output to an audio amplifier or other audio device, using the included 5-pin captive screw connector. Balanced and unbalanced audio is supported.

Balanced audio connections use two signal wires and a ground to minimize interference in audio signals. Unbalanced audio connections use one signal wire and a ground and are used if system components don't support balanced signals.

Balanced Audio using XLR Connectors

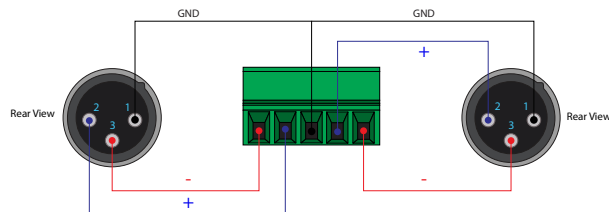

Unbalanced Audio using RCA Connectors

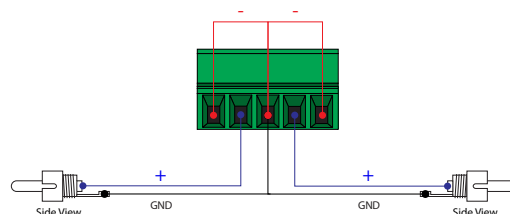

Relay Connector

The AT-HDVS-SC-RX provides a **RELAY** port, allowing the control of screens, curtains, and other devices. Use a 48 V DC relay with no more than 1 A current draw.

When the AT-HDVS-SC-RX is powered-on or rebooted, **C1** and **C2** are set to the Normally Open (NO) state.

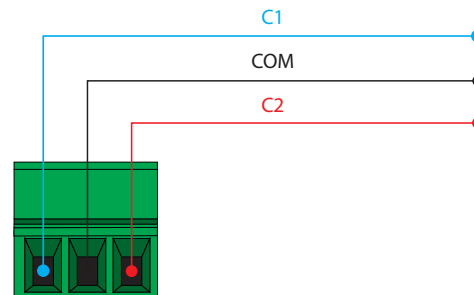
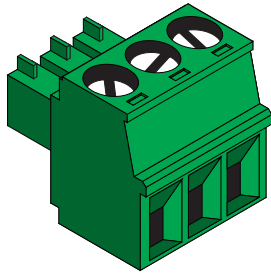

Connection Instructions

1. Connect an Ethernet cable from an HDBaseT-capable device to **INPUT 1** on the rear of the unit.
2. Connect an HDMI cable from the **INPUT 2** port to a UHD/HD source.
3. Connect an HDMI cable from **HDMI OUT** port to a UHD/HD display.
4. Connect an RS-232 control and/or display device to the RS-232 port using the included 5-pin captive screw connector. Each RS-232 port serves a different function.
 - **RS-232 1**
Used to control an external display device.
 - **RS-232 2**
Used to control the AT-HDVS-SC-RX.
5. Connect an amplifier, such as the AT-GAIN-60, to the **AUDIO OUT** port using the included 5-pin captive screw connector.
6. Connect the relay leads from the control motors of the projection screen, blinds, or curtains, of the relay outputs to the **RELAY** port, using the included 3-pin captive screw connector. Use a 48 V DC relay with no more than 1 A current draw.
7. Connect an Ethernet cable from the **LAN** port to a network switch for set-up and control of the unit.
8. Connect the included power supply to the **DC 24V** power receptacle.
9. Connect the IEC power cable to an available 120 / 240 V AC outlet.

Refer to the tables below for recommended cabling when using Altona products with HDBaseT technology. The green bars indicate the signal quality when using each type of cable. Higher-quality signals are represented by more bars. *These table are for guidance, only. Performance may vary, based on environmental factors.*

Core	Shielding	CAT5e	CAT6	CAT6a	CAT7
Solid	UTP (unshielded)	■	■■■	■■■■	N/A
	STP (sheilded)	■■	■■■■	■■■■■	■■■■■

Cable	Max. Distance @ 4K	Max. Distance @ 1080p
CAT5e / CAT6	230 feet (70 meters)	330 feet (100 meters)
CAT6a / CAT7	330 feet (100 meters)	330 feet (100 meters)

 **IMPORTANT:** Stranded or patch cable is not recommended due to performance issues. Sheilded cables are strongly recommended to minimize signal noise and interference.

Connection Diagram

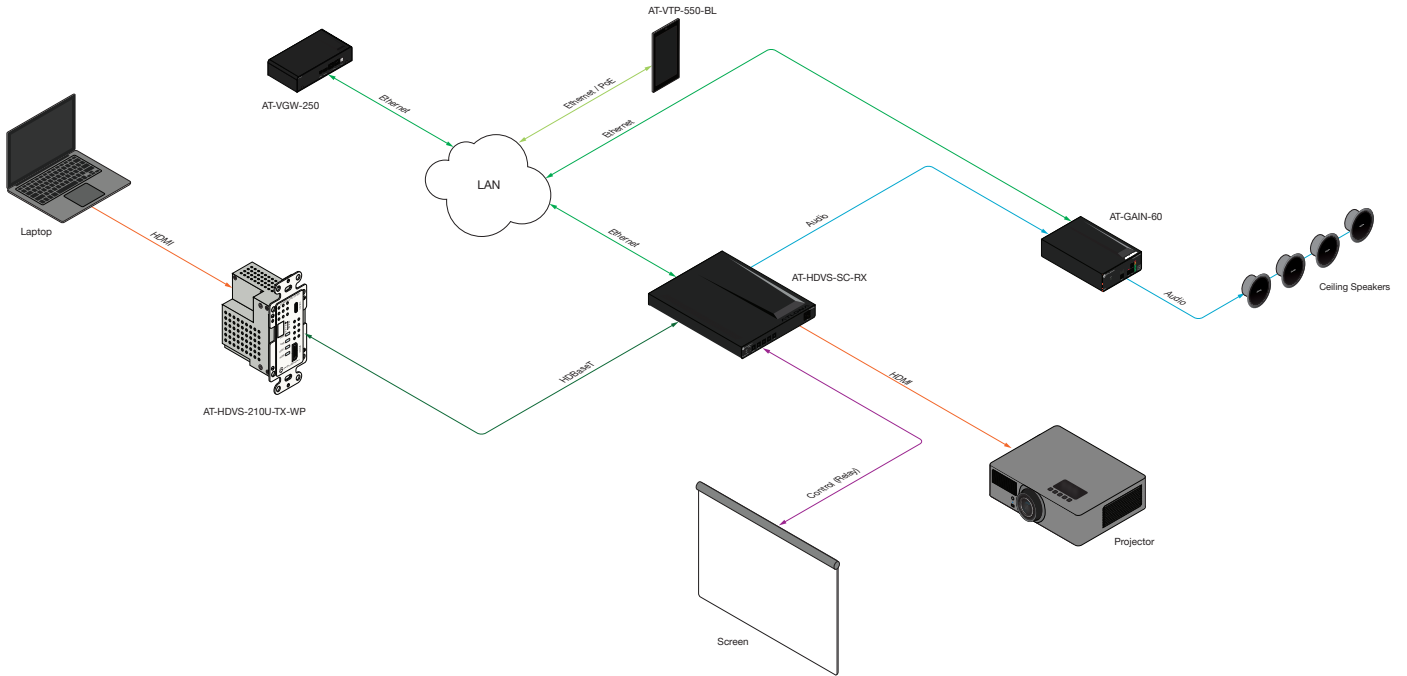

IP Configuration

The AT-HDVS-SC-RX is shipped with DHCP enabled. Once connected to a network, the DHCP server (if available), will automatically assign an IP address to the unit. Execute the `arp -a` command at the Windows command line or use an IP scanner to locate the AT-HDVS-SC-RX on the network.

If the AT-HDVS-SC-RX is unable to detect a DHCP server, within 15 seconds, then the unit will be placed in APAPI mode and assigned the following IP address and subnet mask:

- IP address 169.254.0.0
- Subnet mask 255.255.0.0

To manual change the IP settings or switch between DHCP and static IP mode, use one of the methods below

Using the OSD

1. Make sure the AT-HDVS-SC-RX is powered.
2. Connect an HDMI cable from the **HDMI OUT** port on the AT-HDVS-SC-RX to the HDMI input port on a display.
3. Press the **MENU** button on the front panel of the AT-HDVS-SC-RX to display the menu system.

The **Change IP address** should be highlighted. If not, press the **UP** or **DOWN** cursor buttons on the front panel to select this option.

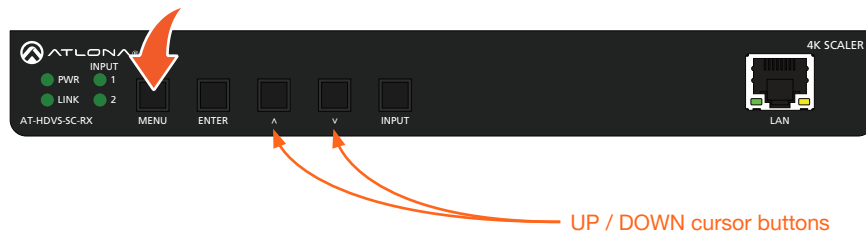
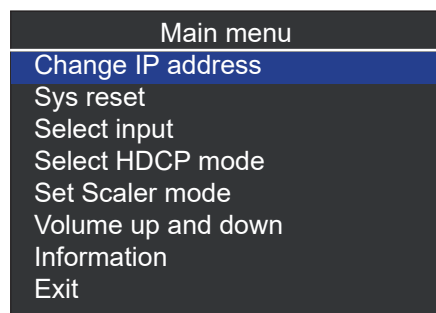

5. Press the **ENTER** button. The **IP Mode** option will be highlighted.
6. Press the **ENTER** button to select the **IP Mode** option. The **IP Mode** option will be highlighted in green.

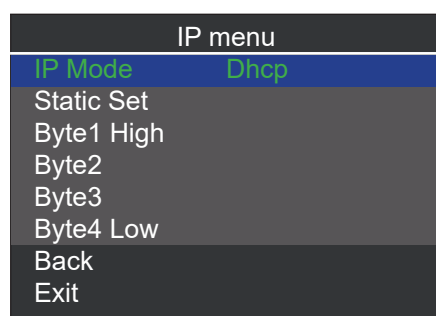

7. Press the **UP** or **DOWN** cursor buttons on the front panel to toggle between **Dhcp** and **Static**.
8. Press the **ENTER** button to set the desired IP mode.

When set to **Static** mode, each byte of the IP address can be set: Press the **UP** or **DOWN** cursor buttons to highlight the desired field, then press **ENTER** to select the field. Press the **UP** or **DOWN** buttons to change the byte value. Press the **ENTER** button to confirm the value.

IP menu	
IP Mode	Static
Static Set	IP
Byte1 High	192
Byte2	168
Byte3	1
Byte4 Low	254
Back	
Exit	

Setting the IP Address Using Commands

Use the IPStatic and IPDHCP commands to switch between DHCP and IP mode through RS-232 or Telnet. Refer to API documentation for more information. All commands and their arguments are case-sensitive.

- **Setting static IP mode**

1. Connect to the AT-HDVS-SC-RX using RS-232 or Telnet.
2. At the command line, execute the IPDHCP command using the off argument, as shown.

```
IPDHCP off
```

3. Execute the IPStatic command. This command requires three arguments: the desired IP address of the AT-HDVS-SC-RX, the subnet mask, and the gateway address. All arguments must be entered in dot-decimal notation. The following is an example:

```
IPStatic 192.168.1.112 255.255.255.0 192.168.1.1
```

└── IP address ─┘
└── Subnet mask ─┘
└── Gateway ─┘

- **Setting DHCP mode**

1. Connect to the AT-HDVS-SC-RX using RS-232 or Telnet.
2. At the command line, execute the IPDHCP command using the on argument, as shown. All characters are case-sensitive.

```
IPDHCP on
```

Once DHCP is enabled, the unit will be assigned an IP address by the DHCP server (if present).

Setting the IP Address using the Web GUI

The **System page (page 32)**, in the web GUI, allows the AT-HDVS-SC-RX to use either DHCP or static IP mode. In order to access the web GUI, the IP address of the AT-HDVS-SC-RX must be known.

1. Open the desired web browser and enter the IP address of the AT-HDVS-SC-RX.
2. Log in, using the required credentials. The factory-default username and password are listed below:

Username: root
 Password: Atlona

3. Click **System** in the menu bar.

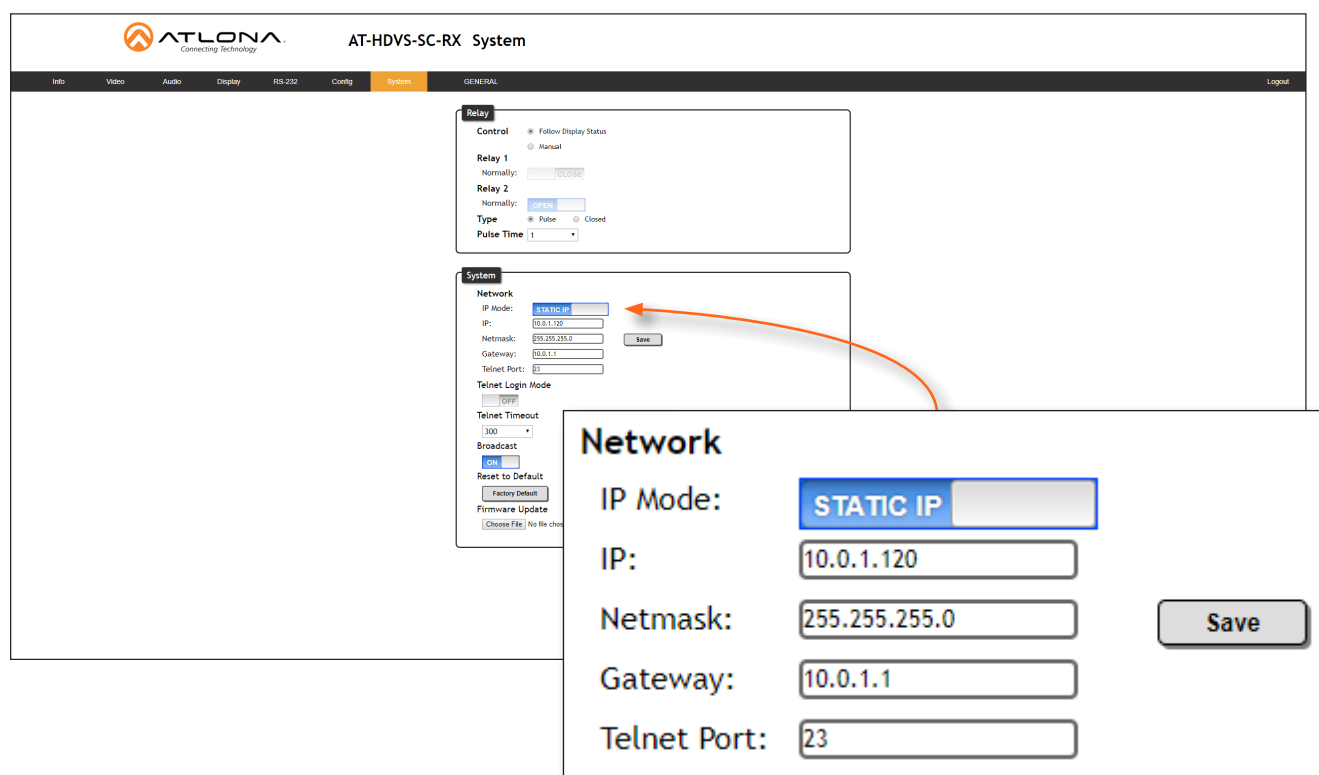

4. Click the **IP Mode** toggle to switch between the **DHCP** and **STATIC IP** setting. When set to **STATIC IP**, the **IP**, **Netmask**, and **Gateway** fields can be modified.
5. Click the **Save** button to save the changes.

Basic Operation

Managing Users

The AT-HDVS-SC-RX allows the **admin** user to create, edit, and remove additional TCP/IP users. All users have the same level of access to control the AT-OME-TX21-WP-E. However, only the **admin** user is allowed to manage other users. Up to three additional users can be created.

Adding Users

1. Open the desired web browser and enter the IP address of the AT-HDVS-SC-RX.
2. Log in as the **admin** user with the required credentials. The factory-default username and password for the admin user are listed below:

Username: root
 Password: Atlona

3. Click **Config** in the menu bar.

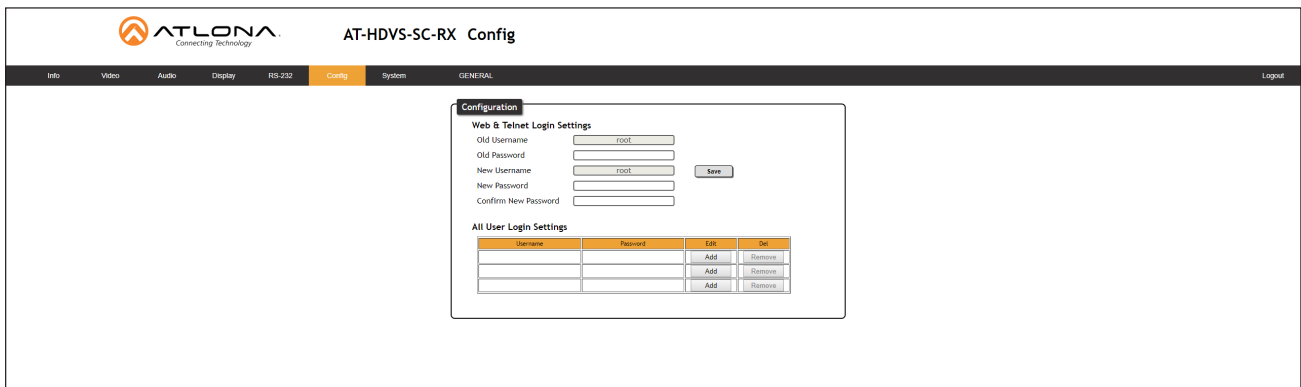

4. Click the **Add** button, under the **Edit** column.
5. Enter the desired username and password in the **Username&Password Edit** dialog box.

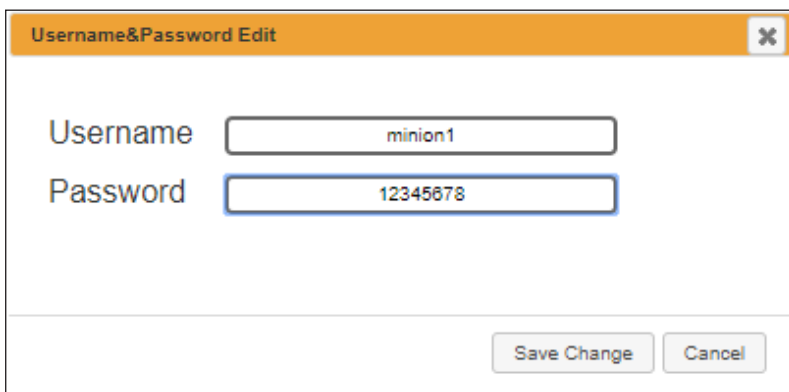

6. Click the **Save Change** button to commit changes or click the **Cancel** button to return to the **Config** page without adding the user.

Once created, the new user and the associated password will appear under the **All User Login Settings** section. To login with the new username, click **Logout** in the upper-right corner of the screen, then enter the login credentials for the user on the **Login** page.

Editing / Deleting Users

The username and password of a user can be changed using this method.

1. Open the desired web browser and enter the IP address of the AT-HDVS-SC-RX.
2. Log in as the **admin** user with the required credentials. The factory-default username and password for the admin user are listed below:

Username: root
 Password: Atlona

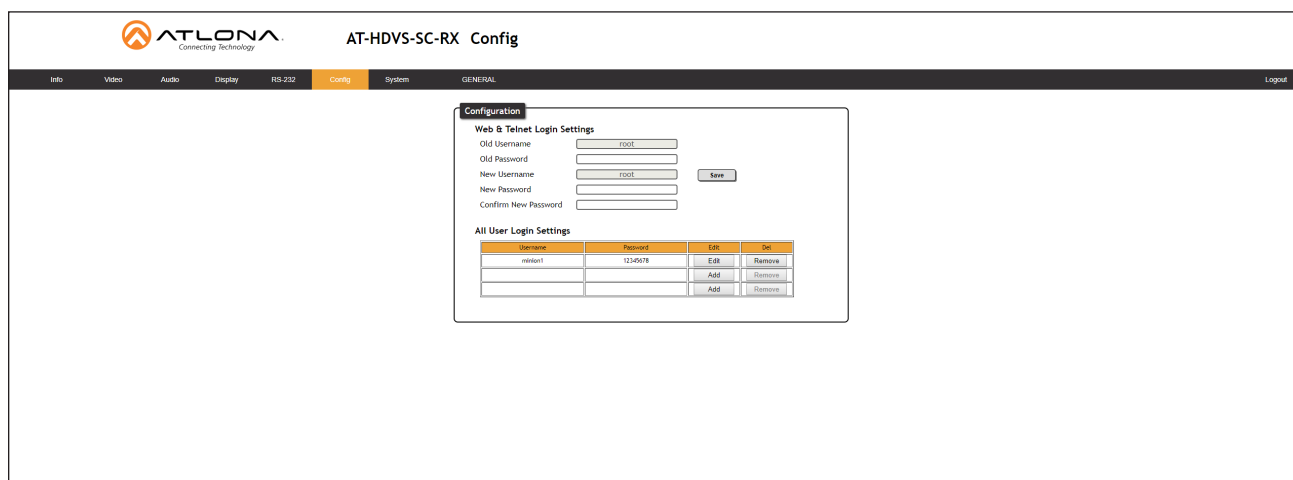

Editing Users

- a. Click **Config** in the menu bar.
- b. Click the **Edit** button next to the user to be changed.
- c. Enter the new information for the user in the **Username&Password Edit** dialog box.
- d. Click the **Save Change** button to commit changes or click the **Cancel** button to return to the **Config** page without making changes.



Deleting Users

- a. Click the **Remove** button next to the user to be deleted.

The Web GUI

Accessing the Web GUI

The AT-HDVS-SC-RX includes a built-in web GUI. Atlona recommends that the web GUI be used to set up the AT-HDVS-SC-RX, as it provides intuitive management of all features.

The AT-HDVS-SC-RX is shipped with DHCP enabled. Once connected to a network, the DHCP server will automatically assign an IP address to the unit. Use an IP scanner to determine the IP address of the AT-HDVS-SC-RX. If a static IP address is desired, refer to [IP Configuration \(page 14\)](#). The default static IP address of the AT-HDVS-SC-RX is 192.168.1.254.

1. Launch a web browser.
2. In the address bar, type the IP address of the AT-HDVS-SC-RX.
3. The **Login** page will be displayed.



4. Type root, using lower-case characters, in the **Username** field.
5. Type Atlona in the **Password** field. This is the default password and is case-sensitive. When the password is entered, it will be masked. The password can be changed, if desired. Refer to the [Config page \(page 31\)](#) for more information.
6. Click the **Submit** button or press the ENTER key on the keyboard.

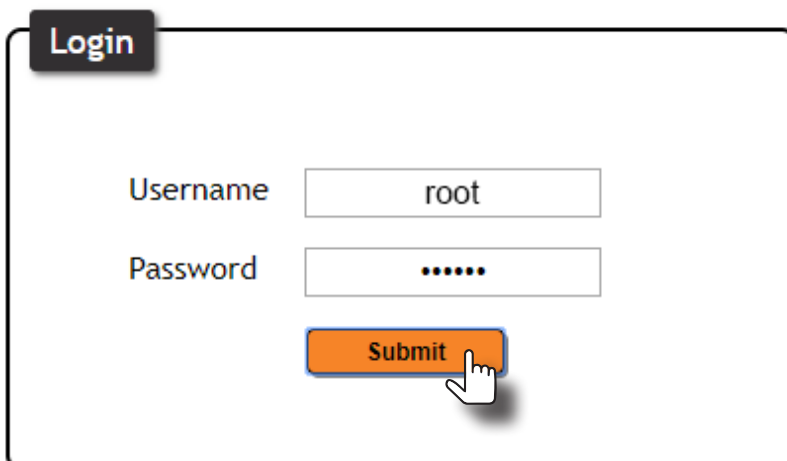

Info page

After logging in, the **Info** page is the first page to be displayed. The **Info** page displays information such as the model name, software, and active input, and output video resolution.

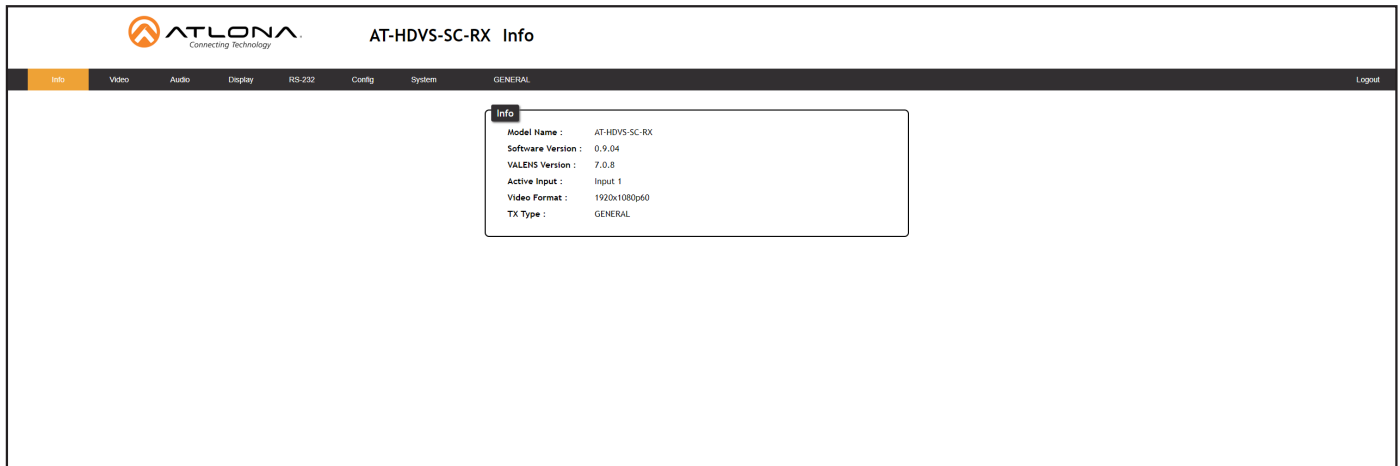

Model Name

The model SKU of this product.

Software Version

The version of firmware that the AT-HDVS-SC-RX is running. Always make sure to check the AT-HDVS-SC-RX product page, on the Atlona web site, for the latest version of firmware.

VALENS Version

Displays the version of firmware used by the Valens chipset.

Active Input

The currently selected input on the AT-HDVS-SC-RX.

Video Format

Displays the output resolution on the **HDMI OUT** port.

TX Type

The model of the connected PoE-compatible transmitter (TX) that is connected to the AT-HDVS-SC-RX.

Note that if the AT-HDVS-SC-RX is connected to a transmitter, then the model of the Atlona transmitter will be displayed in the menu bar, to the right of the HDBT menu. If no transmitter is connected, the text "GENERAL" will be displayed.

Video page

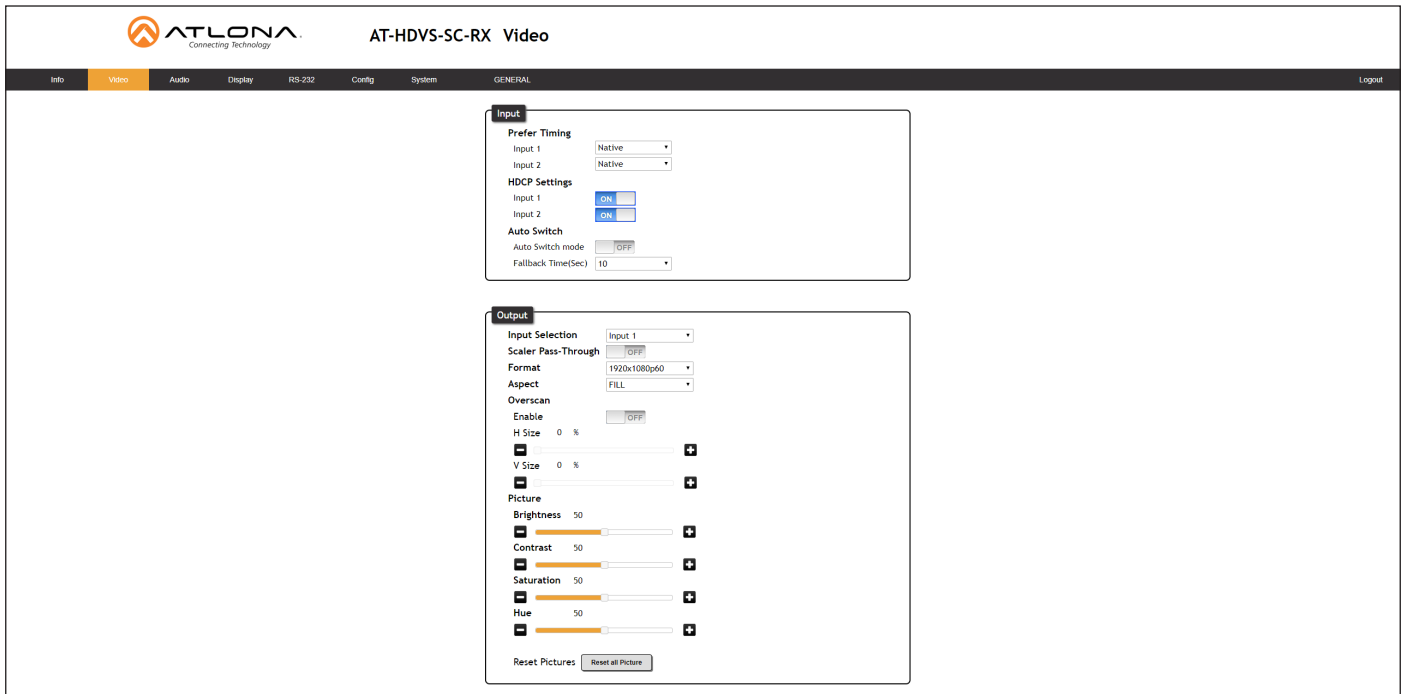

Prefer Timing

Click this drop-down list to select the desired input resolution.

Available Resolutions			
Native	1280x720	1440x900	1920x1200
800x600	1280x800	1600x900	2560x1440
1024x768	1366x768	1920x1080	3840x2160

HDCP Settings

HDCP can be controlled on each input. Set this toggle switch to the **ON** position to set the HDCP reporting mode of each input (**HDMI IN, HDBaseT**). Some devices will automatically send HDCP content if an HDCP-compliant display is detected. Setting this toggle switch to the **OFF** position, will force the device to ignore detection of HDCP-compliant displays, allowing non-HDCP content to be transmitted from the source. Note that setting this feature to the **OFF** position does *not* decrypt HDCP content.

Auto Switch



- Click the **Auto Switch mode** to the **ON** position to enable auto-switching. If the AT-HDVS-SC-RX detects a signal loss at one of the inputs, then it will automatically switch to the opposite input. Set to the OFF position to disable auto-switching.
- Click the **Fallback Time** drop-down list to select the fallback time interval. The AT-HDVS-SC-TX will wait until the fallback timer expires before auto-switching to the other input. Range: 3 - 600 seconds.



NOTE: When setting the fallback time interval, make sure that the Auto Power Off timer is at least six seconds longer than the fallback time interval. Refer to the [Display page \(page 25\)](#) for more information.

Input Selection

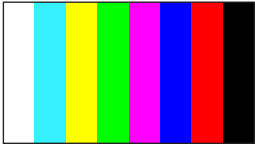
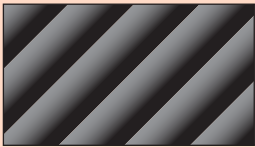
Click this drop-down list to select the desired active input. In addition to selecting an input, internal video test patterns can also be selected.

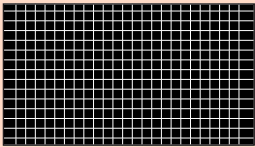
Inputs	
Input 1	HDBaseT
Input 2	HDMI
Internal Pattern 1	 <p>Color Bars This pattern is used to calibrate color settings on the display device.</p>
Internal Pattern 2	 <p>Gray Scale This pattern is used to calibrate brightness and contrast.</p>
Internal Pattern 3	 <p>Moving Bar This pattern is can be applied when troubleshooting video walls, by making sure all displays are in phase with one another. If all displays are in phase, there will be no “lag” in the moving bar.</p>
Internal Pattern 4	 <p>Grid This pattern is used mainly for detection of corner convergence (“pin cushions”). Corner convergence is represented by the “bending” of the horizontal and vertical lines in the corners of the screen.</p>

Scaler Pass-Through

Click this toggle switch to the **ON** position to pass-through the source signal without scaling or image processing.

Format

Click this drop-down list to set the output resolution of the scaler. This option is not available when the **Scaler Pass-Through** option is set to **ON**.

Format			
640x480p60	1280x768p60	1920x1080i50	2048x1080p60
800x600p60	1280x800p60	1920x1080i60	2048x1200p60
848x480p60	1280x1024p60	1920x1080p24	3840x2160p24
1024x768p60	1360x768p60	1920x1080p25	3840x2160p25
1152x870p75	1366x768p60	1920x1080p30	3840x2160p30
1280x720p30	1440x900p60	1920x1080p50	4096x2160p24
1280x720p50	1680x1050p60	1920x1080p60	4096x2160p25
1280x720p60	1600x1200p60	1920x1200p60	4096x2160p30

Aspect

Click this drop-down list to set the aspect ratio of the output signal. This option is not available when the **Scaler Pass-Through** option is set to **OFF**.

Overscan

Click this toggle switch to the **ON** position to enable overscan. When this feature is enabled, click and drag the **H Size** and **V Size** slider bars to adjust the horizontal and vertical overscan percentage, respectively. When both slider bars are set to 0 %, then no horizontal or vertical overscan is applied to the output signal.

Picture

Click and drag each of these slider bars to adjust the **Brightness**, **Contrast**, **Saturation**, and **Hue** of the output signal. The default value for both slider bars is 50.

Reset all Picture

Click this button to set all picture settings to the factory-default value.

Audio page

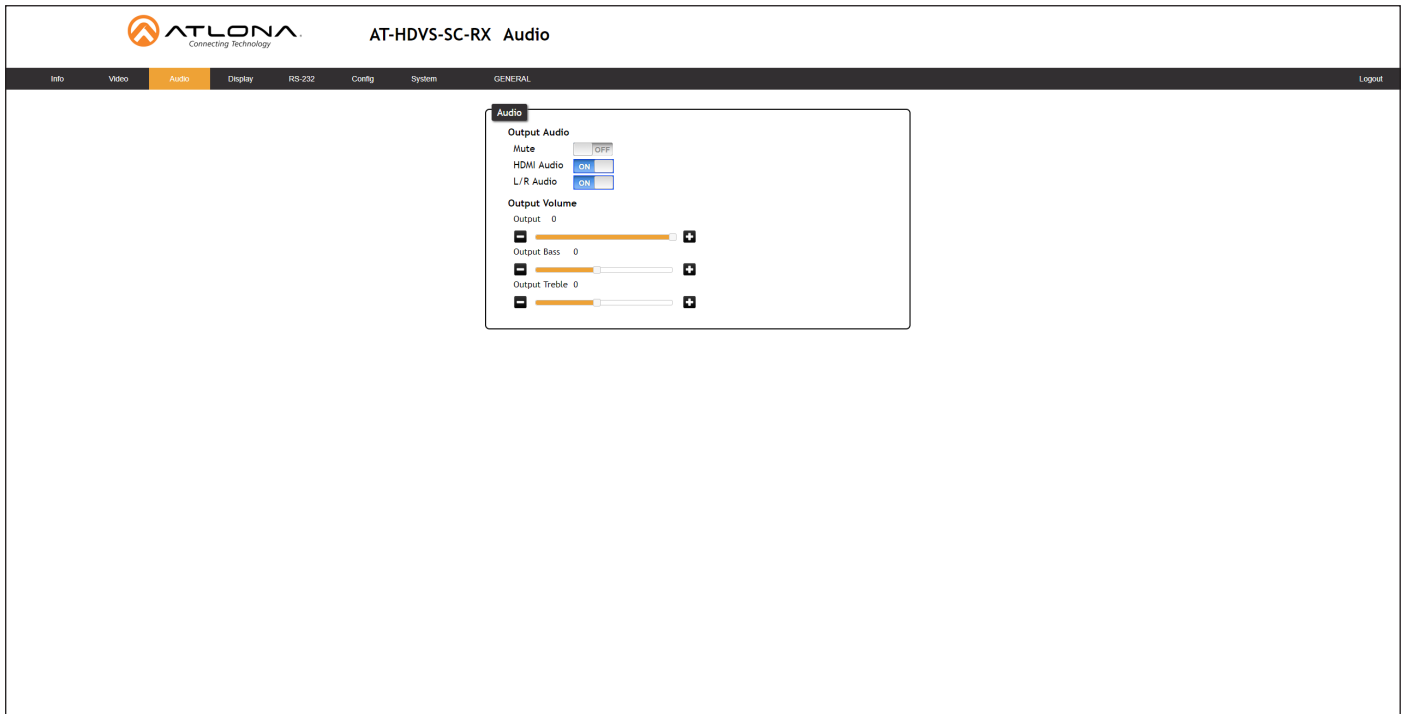

Mute

Click this toggle switch to the **ON** position to mute all audio on the output.

HDMI Audio

Click this toggle switch to the **OFF** position to mute only the audio on the HDMI output.

L/R Audio

Click this toggle switch to the **OFF** position to mute only the audio on the **AUDIO OUT** port.

Output

Click and drag this slider bar to adjust the audio output volume. Range: -80 to 0. Values are in decibels.

Output Bass

Click and drag this slider bar to adjust the bass of the audio output. Range: -15 to 15.

Output Treble

Click and drag this slider bar to adjust the treble of the audio output. Range: -15 to 15.

Display page

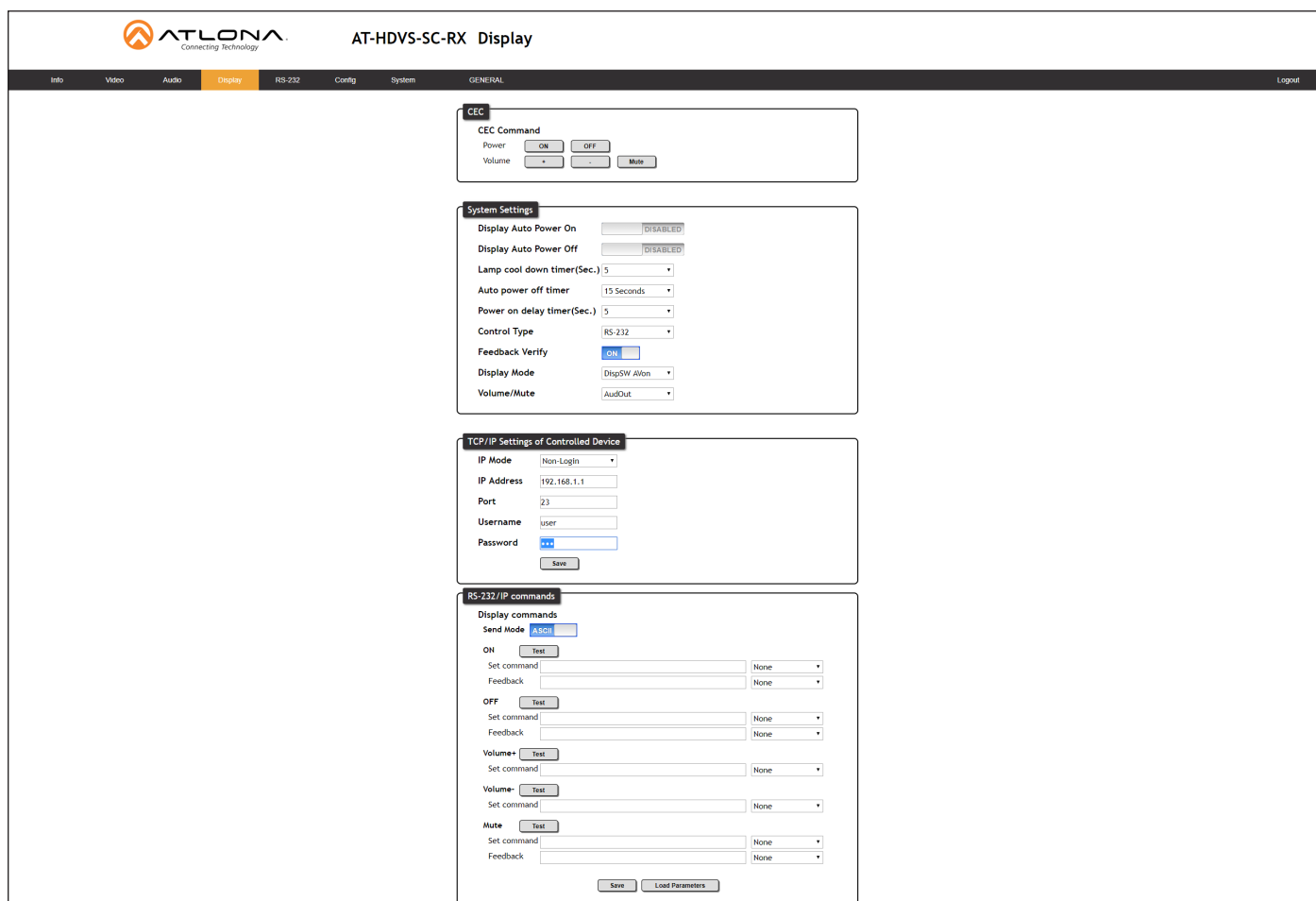

Power

Click the **ON** or **OFF** button to power-on or power-off the display using CEC.

Volume

Click the **+** or **-** button to increase or decrease the audio output volume, respectively. Click the **Mute** button to mute the output audio.

Consumer Electronics Control (CEC) Notice:

Atlona has confirmed proper CEC functionality with several current models of Samsung, Panasonic, and Sony displays. However, it is not guaranteed that CEC will work with all displays. Many manufacturers do not support the CEC "off" command, and older displays use proprietary commands. Atlona only supports displays that use the CEC command structure defined in HDMI 1.2a. It is recommended that dealers request an evaluation product from Atlona, before designing a system using the CEC protocol. If this is not possible, then other control methods will need to be considered, in order to control displays using Atlona products.

Display Auto Power On

Click this toggle switch to **ENABLE** to send the command to power-on the display when an A/V signal is detected. Otherwise, set to **DISABLE** to turn this feature off.

Display Auto Power Off

Click this toggle switch to **ENABLE** to send the command to power-off the display when an A/V signal is no longer present. Otherwise, set to **DISABLE** to turn this feature off.

Lamp cool down timer (Sec.)

Sets the cool-down interval, in seconds, before the projector can be powered-off. During this time interval, the projector will not accept any “power on” or “power off” commands until the last “power off” command has been processed and the projector lamp has completed the cool-down cycle. Range: 0 to 300.

Auto power off timer

Sets the time interval, in seconds, between when the loss of A/V signal is detected and when the “Display Off” command is sent. Range: 5 seconds to 1 hour.



NOTE: If using this timer with the Fallback Time interval (Auto-Switching), this value should be at least six seconds longer than the Fallback Time interval. Refer to the [Video page \(page 21\)](#) for more information.

Control Type

Sets the control method for sending commands. The following options are available: RS-232, IP, CEC.

Setting	Description
RS-232	RS-232 is used to send commands.
IP	Commands are sent over IP.
CEC	Uses CEC to send commands.

Feedback Verify

Sets the feedback verification state. Click the toggle to enable or disable this feature. The following options are available.

Setting	Description
On	This is the default setting. The AT-HDVS-SC-RX will make four attempts to send the command, if the feedback string is not acknowledged. After the fourth attempt, the process will fail.
Off	Sends the command and ignores the feedback string.

Display Mode

Click this drop-down list to select the behavior of the display when a source is connected.

Setting	Description
DispSW AVon	Display switches on/off, source audio/video signal is always on.
DispSW AVSW	Display switches on/off, source audio/video signal switches on/off.
AV SW	Display is always on, source audio/video signal switches on/off; Lamp cool down timer (Sec.) and Power on delay timer (Sec.) are ignored.

IP Mode

Click this drop-down list to select the login mode.

Setting	Description
Non-login	Does not require a username and password when using TCP/IP to control the display.
Login	Requires a username and password to control the display through TCP/IP.

IP Address

Enter the IP address of the device in this field.

Port

Enter the listening port of the device in this field.

Username

Enter the username for login. If the **IP Mode** is set to Non-Login, then this information will not be required.

Password

Enter the password for login. If the **IP Mode** is set to Non-Login, then this information will not be required.

Save

Click this button to save all changes in this window group.

Send Mode

Sets the display format for the commands in the web GUI. In **Hex** mode, non-valid characters are not accepted.

Options: **ASCII**, **Hex**.

On/Off/Volume+/Volume-/Mute

- **Set command**
Enter the command in this field.
- **Feedback**
Enter the feedback string in this field.
- **CR-LF**
Click this drop-down list to select the desired end-of-line characters to be sent.
- **Test**
Click this button to test the command line and/or feedback.

Setting	Description
None	No end-of-line characters included
CR	Carriage return
LF	Line feed
CR-LF	Carriage return + Line feed
Space	Space character
STX	Start-of-text character
ETX	End-of-text character
Null	Null character (binary zero)

Save

Click this button to save all changes in this window group.

RS-232 page

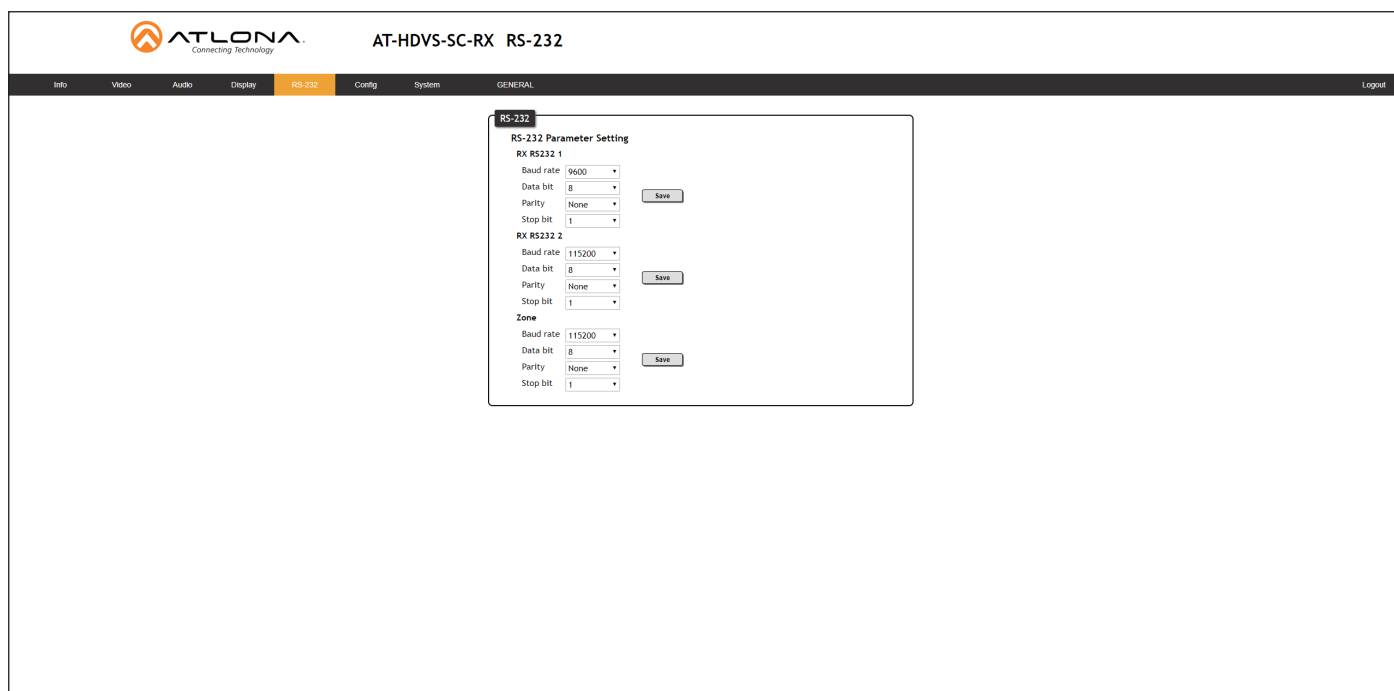

Zone

When the AT-HDVS-SC-RX is connected to the AT-HDVS-SC-RX, the drop-down list boxes will be disabled and the HDBaseT baud rate will be locked at 115200.

If the AT-HDVS-SC-RX is connected to another HDBaseT device, such as the AT-UHD-CLSO-824, each of these drop-down list boxes can be set to the baud rate of the HDBaseT RS-232 settings on the corresponding device. Click the **Save** button to accept the settings.

TX RS-232

When the AT-HDVS-SC-RX is connected to the AT-HDVS-SC-RX, the drop-down list boxes will be disabled and the HDBaseT baud rate will be locked at 115200.

If the AT-HDVS-SC-RX is connected to another HDBaseT device, such as the AT-UHD-CLSO-824, each of these drop-down list boxes can be set to the baud rate of the HDBaseT RS-232 settings on the corresponding device. Click the **Save** button to accept the settings.

Setting	Description
Baud rate	Sets the baud rate. The following options are available: 2400, 9600, 19200, 38400, 56000, 57600, 115200.
Data bit	Sets the number of data bits used to represent each character of data. The following options are available: 7 or 8.
Parity	Sets the parity bit, which can be included with each character to detect errors during the transmission of data. The following options are available: None, Odd, or Even.
Stop bit	Sets the stop bit. Stop bits are sent at the end of each character, allowing the client to detect the end of a character stream. The following options are available: 1 or 2.

RX RS-232 Zone 1

Each of these drop-down lists refer to the setting for the RS-232 1 port on the receiver. Click the **Save** button to accept the settings.

Setting	Description
Baud rate	Sets the baud rate. The following options are available: 2400, 9600, 19200, 38400, 56000, 57600, 115200.
Data bit	Sets the number of data bits used to represent each character of data. The following options are available: 7 or 8.
Parity	Sets the parity bit, which can be included with each character to detect errors during the transmission of data. The following options are available: None, Odd, or Even.
Stop bit	Sets the stop bit. Stop bits are sent at the end of each character, allowing the client to detect the end of a character stream. The following options are available: 1 or 2.

Config page

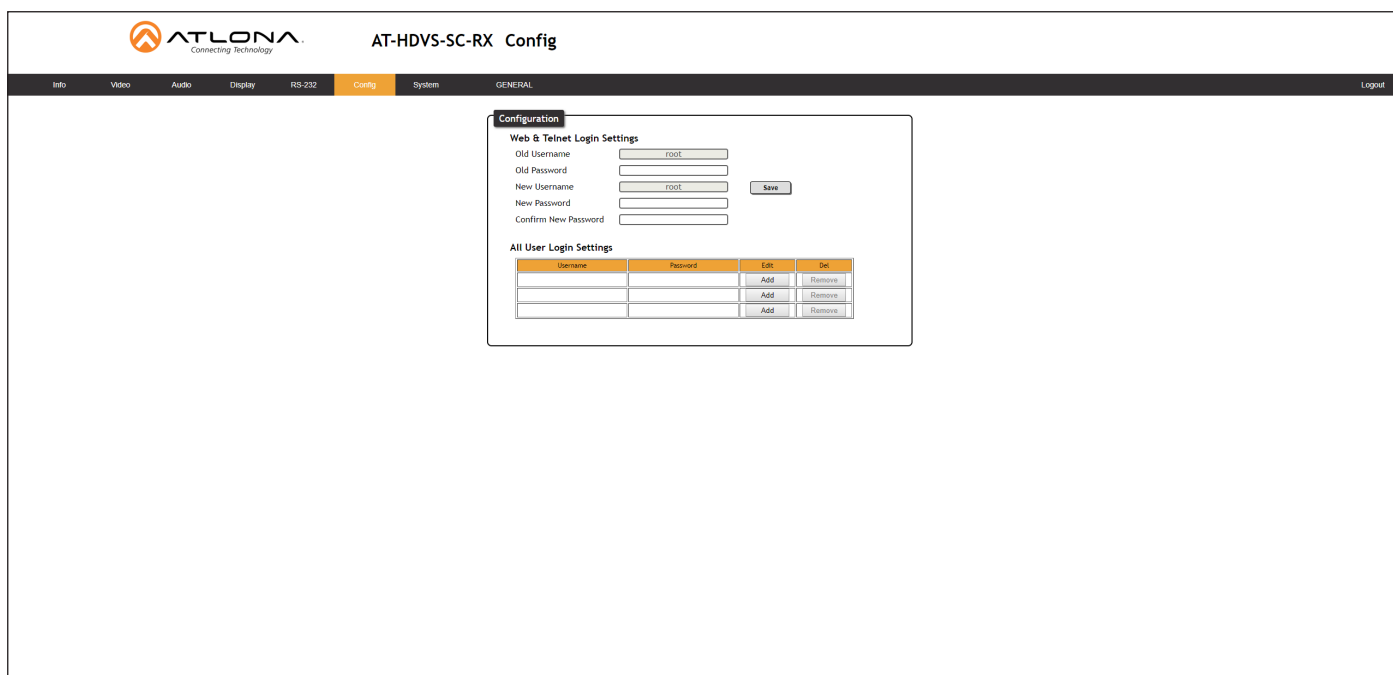

Old Username

This field cannot be changed. “admin” is the administrator user.

Old Password

Enter the current password for the “admin” username in this field. The default password is “Atlona”.

New Username

This field cannot be changed.

Save

Click this button to save all changes.

New Password

Enter the new password for the “admin” username in this field.

Confirm New Password

Verify the new password by retying it in this field.

All User Login Settings

- **Username**
Displays the username.
- **Password**
Displays the password for the associated username.
- **Edit**
Click the **Add** button, in this column, to edit the username and password in the row.
- **Del**
Click the **Remove** button to delete the user in the row. This button will only be available if both a username and password have been created.

System page

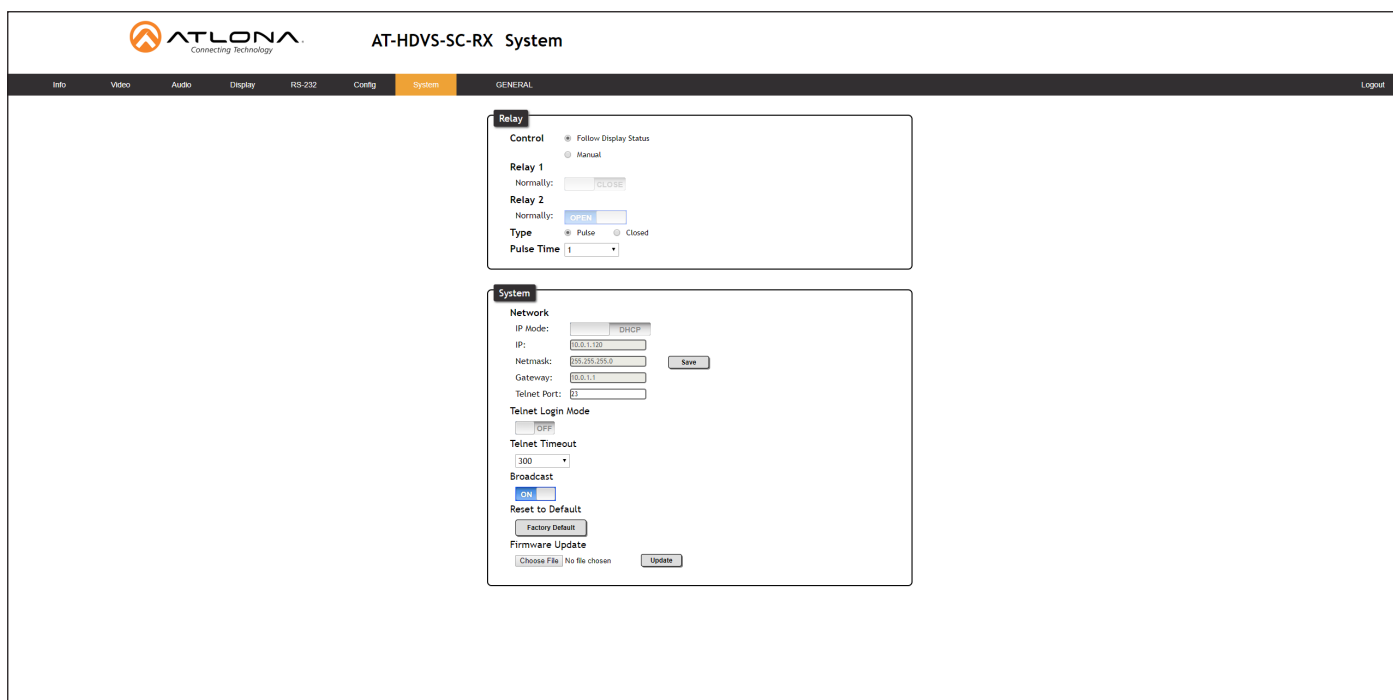

Control

Click this radio button to select the behavior of the relays. Each relay has two states: normally open (NO) and normally closed (NC).

Setting	Description
Follow Display	The relays will toggle, based on the state of the AT-HDVS-SC-RX. For example, when the system is powered on, the relay will power-on the display. If the system is powered off, then the display will be powered off.
Manual	Relays can be triggered manually using the web GUI or using the RelayAct and RelayAuto commands. Refer to the API documentation for more information.

Relay 1

Click this toggle switch to Relay 1 to the OPEN (NO) or CLOSE (NC) state.

Relay 2

Click this toggle switch to Relay 2 to the OPEN (NO) or CLOSE (NC) state.

Type

Click this radio button to select the type of relay.

Type	Description
Pulse	The pulse relay is a (also called a “latch” relay) maintains either contact position, without power being applied. Relay contacts retain this setting across a power outage.
Closed	This type of relay toggles between NO and NC, when triggered.

IP Mode

Click this toggle switch to set the IP mode of the AT-HDVS-SC-RX. By default, the AT-HDVS-SC-RX is set to **DHCP** mode.

IP

Enter the IP address of the AT-HDVS-SC-RX in this field. This field will only be available if **IP Mode** is set to **STATIC IP**.

Netmask

Enter the subnet mask in this field. This field will only be available if **IP Mode** is set to **STATIC IP**.

Gateway

Enter the gateway (router) address in this field. This field will only be available if **IP Mode** is set to **STATIC IP**.

Telnet Port

Enter the Telnet port in this field.

Telnet Login Mode

Click this toggle switch to set the login mode to **ON** or **OFF**. If this feature is set to **ON**, then the AT-HDVS-SC-RX will prompt for both the username and password. Use the same login credentials as the web GUI.

Telnet Timeout

Click this drop-down list to select the timeout interval, in seconds, before the Telnet connection is automatically closed after no activity. Range: 1 to 3600.

Broadcast

By default, broadcast mode is set to **ON**. When set to **ON**, changes in the web GUI will also be affected on the control system (if connected), via TCP/IP. To separate control between web GUI and Telnet, set this feature **OFF**.

Reset to Default

Click the **Factory Default** button to set the AT-HDVS-SC-RX to factory-default settings.

Firmware Update

Click the **Choose File** button to select the firmware file, when upgrading the firmware on the AT-HDVS-SC-RX. Once the firmware file is selected, click the **Update** button. Refer to [Updating the Firmware \(page 34\)](#) for more information.

Updating the Firmware

Updating the firmware can be completed using either the USB interface or the web GUI. Atlona recommends using the web GUI for updating the firmware. However, if a network connection is not available, the AT-HDVS-SC-RX firmware can be updated using a USB-A to USB mini-B cable.

Using the Web GUI

Requirements:

- AT-HDVS-SC-RX
 - Firmware file
 - Computer
1. Connect an Ethernet cable from the computer, containing the firmware, to the same network where the AT-HDVS-SC-RX is connected.
 2. Go to the [System page \(page 32\)](#) in the web GUI.

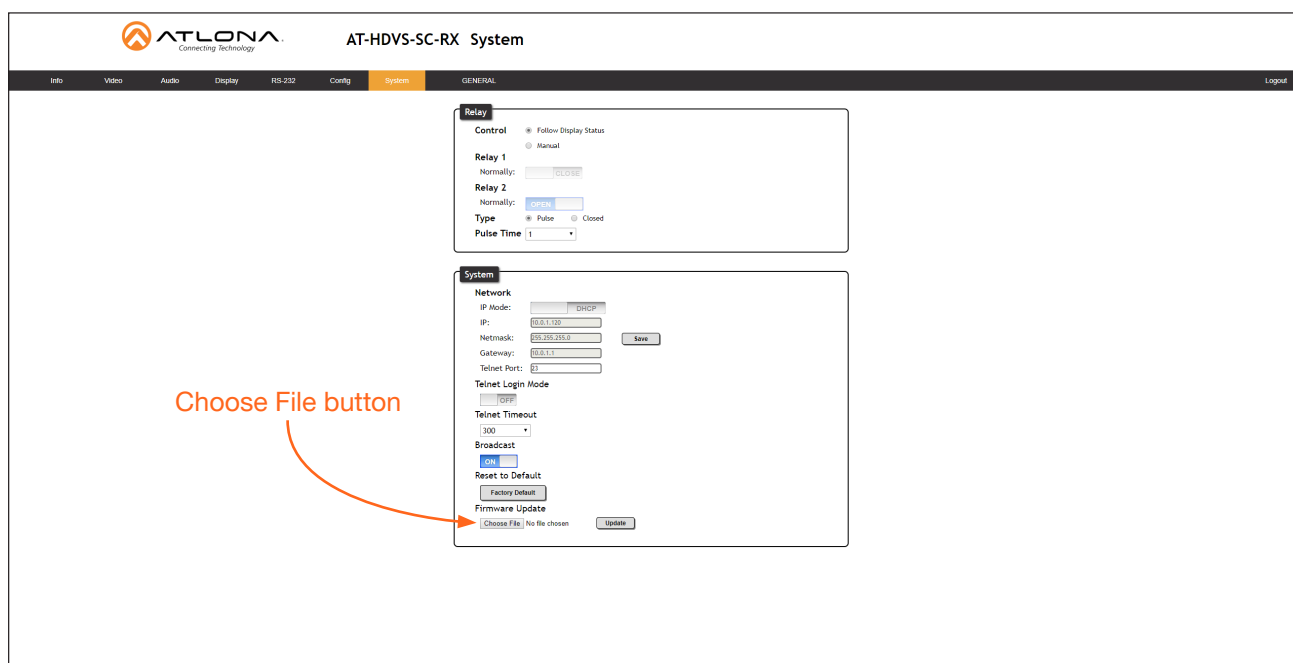

3. Click the **Choose File** button, under the **Firmware Update** section.
4. Browse to the location of the firmware file, select it, and click the **Open** button.
5. Click the **Update** button, under the **Firmware Update** section.
6. The following message box will be displayed.

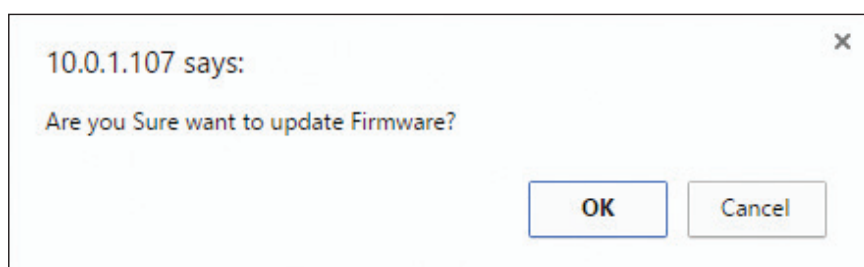

- Click the **OK** button to begin the firmware update process. Click the **Cancel** button to cancel the process.

During the firmware update process, the **PWR** LED indicator will flash, rapidly.

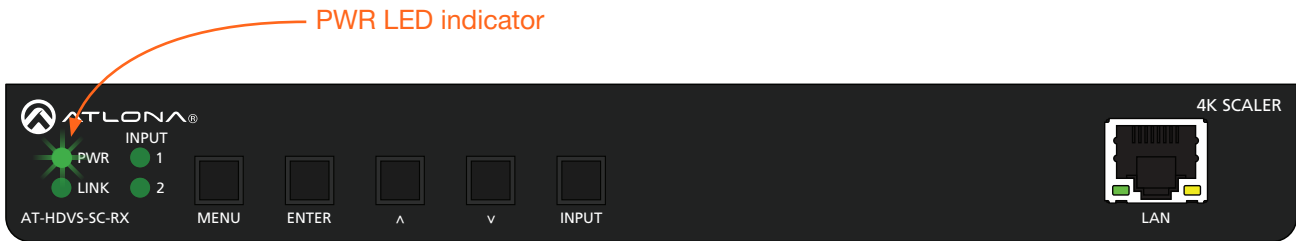

NOTE: The firmware update process may take up to five minutes to complete. When completed, the **PWR** and **INPUT 1** LED indicators will glow solid green, and the backlight on the **MENU** button will glow solid blue. Do not disconnect the power during the firmware update procedure.

- After the firmware update process is complete, the **Login** screen will be displayed.

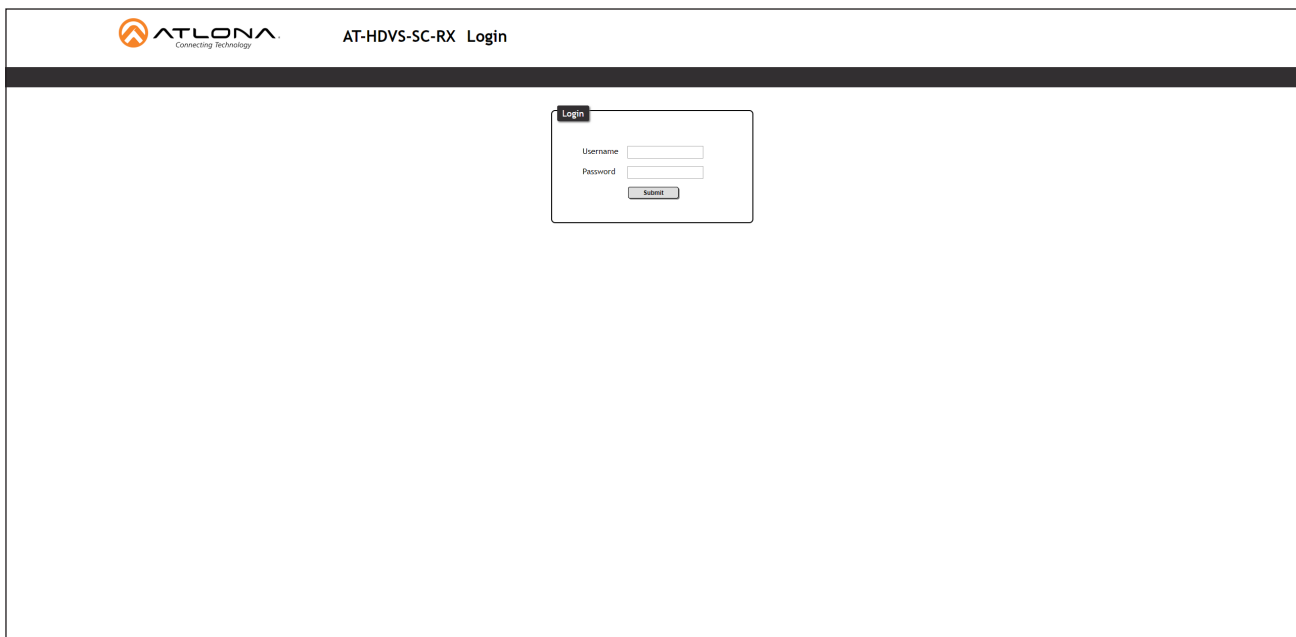

Using USB

Requirements:

- AT-HDVS-SC-RX
- Firmware file
- Computer running Windows
- USB-A to USB mini-B cable

1. Make sure the unit is powered, using the included power supply.
2. Press and hold the **MENU** key. While depressing the **MENU** button, connect the USB cable between the FW port on the AT-HDVS-SC-RX and the computer containing the firmware.

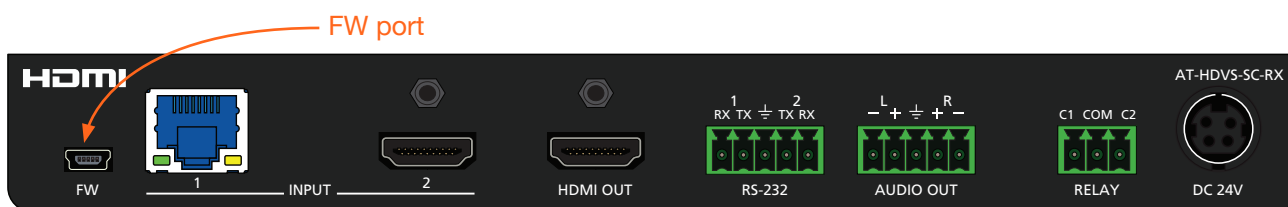

3. The USB UPDATE folder will be displayed.

If this folder is not displayed, automatically, select the USB UPDATE drive from Windows Explorer.

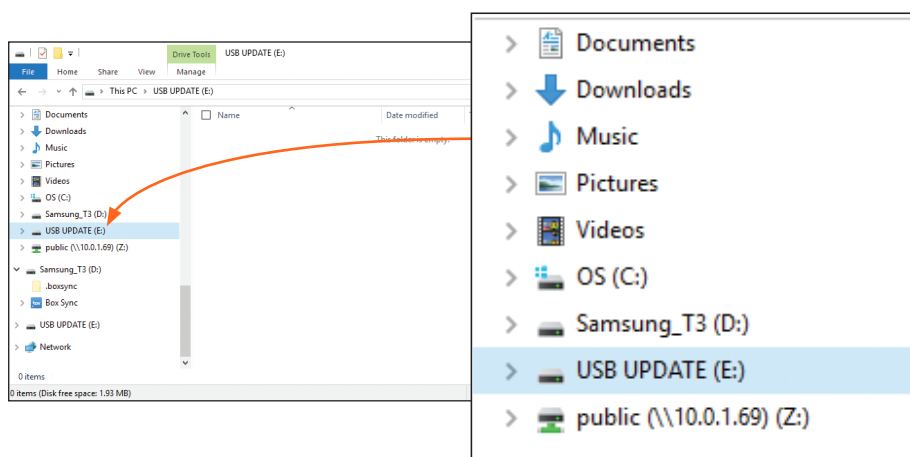

4. Delete all files from the USB UPDATE drive, if any are present.
5. Drag-and-drop the firmware file to the drive folder. The **PWR** LED indicator will flash green during the update procedure.
6. Disconnect the USB cable from the AT-HDVS-SC-RX.
7. The AT-HDVS-SC-RX will automatically reboot. When the **PWR** LED indicator is solid green, the firmware update process will be complete. The unit is now ready for use.

Default Settings

The following tables list the factory-default settings for the AT-HDVS-SC-RX.

Feature	Settings	
AV Settings	Input Selection	Input 1
	Auto Switch Mode	ON
	Fallback Port	Previous
	Fallback Time	5 (seconds)
	HDCP Setting (Input 1)	ON
	HDCP Setting (Input 2)	ON
	Audio Output	ON
System Settings	Display Auto Power On	Disabled
	Display Auto Power Off	Disabled
	Lamp Cool Down Timer	5 (seconds)
	Auto Power Off Timer	15 (seconds)
	Power On Delay Timer	5 (seconds)
	Control Type	RS-232
	Feedback Verify	ON
	Display Mode	DispSW AVon
	IP Mode	Non-Login
	IP Address	255.255.255.255
	Port	65535
RS-232	Zone	
	Baud rate	115200
	Data bit	8
	Parity	None
	Stop bit	1
	TX RS-232	
	Baud rate	115200
	Data bit	8
	Parity	None
	Stop bit	1
	RX RS-232 Zone 1	
	Baud rate	9600
	Data bit	8
	Parity	None
	Stop bit	1
EDID	Input 1	Default (1920x1080p @ 60 Hz)
	Input 2	Default (1920x1080p @ 60 Hz)
	Output	---
Config	Username (default)	root
	Password (default)	Atlona
System	IP Mode	DHCP
	Static IP Address (default)	192.168.1.254
	Netmask	255.255.255.0
	Gateway	192.168.1.1
	Telnet Port	23
	Telnet Login Mode	OFF
	Telnet Timeout	300 (seconds)
	Broadcast	ON
	Power	ON

Specifications

Connectors, Controls, and Indicators	
INPUT 1 (HDBaseT)	1 - RJ45
INPUT 2 (HDMI)	1 - Type A, 19-pin female
USB	1 - Type mini-B, 5-pin female
RS-232	1 - 5-pin captive screw
AUDIO OUT	1 - 5-pin captive screw
RELAY	1 - 3-pin captive screw
LAN	1 - RJ45
DC 24V	1 - 4-pin DIN, locking
Front panel buttons	5 - Momentary, tact-type
LED indicators	4 - LED, green

Video		
HDMI In	UHD/HD/SD	4096x2160@24/25/30Hz, 3840x2160@24/25/30Hz, 1920x1080p@23.97/24/25/29.97/30/50/59.94/60Hz, 1920x1080i@50/59.94/60Hz, 1280x720p@30/50/60Hz, 720x576p@50Hz, 720x576i@50Hz, 720x480p@59.94/60Hz, 640x480p@60Hz
	VESA	2560x1600@60Hz(RB), 2048x1536@60Hz, 2048x1200@60Hz, 2048x1080@60Hz, 1920x1200@60Hz(RB), 1920x1080@60Hz(RB), 1680x1050@60Hz, 1600x1200@60Hz, 1600x900@60Hz, 1440x900@60Hz, 1400x1050@60Hz, 1366x768@60Hz, 1360x768@60Hz, 1280x1024@60Hz, 1280x800@60Hz, 1280x768@60Hz, 1280x720@60Hz, 1152x870@75Hz, 1024x768@60Hz, 848x480@60Hz, 800x600@60Hz, 640x480@60Hz
HDBaseT In	UHD/HD/SD	4096x2160@24/30Hz, 3840x2160@24/25/30Hz, 1920x1080p@23.98/24/25/29.97/30/50/59.94/60Hz, 1920x1080i@50/59.94/60Hz, 1280x720p@30/50/60Hz, 720x576p@50Hz, 720x480p@59.94/60Hz, 640x480p@60Hz
	VESA	2560x1600@60Hz(RB), 2048x1536@60Hz, 2048x1200@60Hz, 2048x1080@60Hz, 1920x1200@60Hz(RB), 1920x1080@60Hz(RB), 1680x1050@60Hz, 1600x1200@60Hz, 1600x900@60Hz, 1440x900@60Hz, 1400x1050@60Hz, 1366x768@60Hz, 1360x768@60Hz, 1280x1024@60Hz, 1280x800@60Hz, 1280x768@60Hz, 1280x720@60Hz, 1152x870@75Hz, 1024x768@60Hz, 848x480@60Hz, 800x600@60Hz, 640x480@60Hz
HDMI Out		4096x2160p@24/25/30Hz, 3840x2160@24/25/30Hz, 1920x1200@60Hz, 1920x1080p@24/25/30/50/60Hz, 1680x1050@60Hz, 1600x1200@60Hz, 1440x900@60Hz, 1360x760@60Hz, 1280x1024@60Hz, 1280x800@60Hz, 1280x768@60Hz, 1024x768@60, 800x600@60Hz, 640x480@60Hz
Color Space		YUV, RGB
Chroma Subsampling		4:4:4, 4:2:2, 4:2:0
Color Depth		8-bit, 10-bit, 12-bit

Audio	
HDMI IN & HDBaseT OUT	PCM 2Ch, LPCM 5.1, LPCM 7.1, Dolby® Digital, DTS® 5.1, Dolby Digital Plus™, Dolby TrueHD, DTS-HD Master Audio™, Dolby Atmos®, DTS:X
Sample Rate	32 kHz, 44.1 kHz, 48 kHz, 88.2 kHz, 96 kHz, 176.4 kHz, 192 kHz
Bit Rate	24-bit (max.)

Resolution / Distance	4K - Feet	4K - Meters	1080p - Feet	1080p - Meters
CAT5e/6	230	70	330	100
CAT6a/7	330	100	330	100
HDMI IN/OUT	15	5	30	10

Signal	
Maximum TMDS Clock	300 MHz
HDBaseT	10.2 Gbps
HDMI	2.0
HDCP	1.4 / 2.2
CEC	2.0

Temperature	Fahrenheit	Celsius
Operating	32 to 122	0 to 50
Storage	-4 to 140	-20 to 60
Humidity (RH)	20% to 90%, non-condensing	

Power	
Consumption	24.75 W
Supply	Input: 100 - 220 V AC, 50/60 Hz, Output: 24 V / 2.7 A DC

Dimensions	Inches	Millimeters
H x W x D (w/o feet)	1.02 x 8.40 x 9.17	26 x 213.5 x 233
H x W x D (w/ feet)	1.22 x 8.40 x 9.37	31 x 213.5 x 233

Weight	Pounds	Kilograms
Device	2.97	1.35

Certification	
Device	CE, FCC
Power Supply	CE, FCC, Level VI, RoHS, cULus, RCM, CCC

Index

A

Audio
muting 24

B

Bass
adjusting 24

C

CEC
compatibility 25
Configuration
IP. See IP configuration
Connection
diagram 10
instructions 10
Contents
package 8
Control type
setting 26
Customer support 3

D

Default settings 37
Description
front / rear panel 9
DHCP 33

F

FCC statement 6
Features 8
Firmware
displaying 20
updating
using the web GUI 34
using USB 36

G

Gateway 33

I

Installation 10

M

Muting
audio 24

O

Operating notes 3

P

Panel descriptions 9
Password
default 19

R

Resolution
setting 21
RS-232
settings 29

S

Safety information 6
Specifications 38
Static IP 33
Subnet mask 33
Switching
auto 21

T

Telnet
listening port 33
login mode 33
timeout 33
Timers
auto-power off 26
projector lamp cool-down 26
Treble
adjusting 24

U

Updating firmware 34
Users
adding 17
deleting 18
editing 18
primary user name 19

W

Warranty 4
Web GUI
accessing 19

