

USB to IP Adapter for Host Device

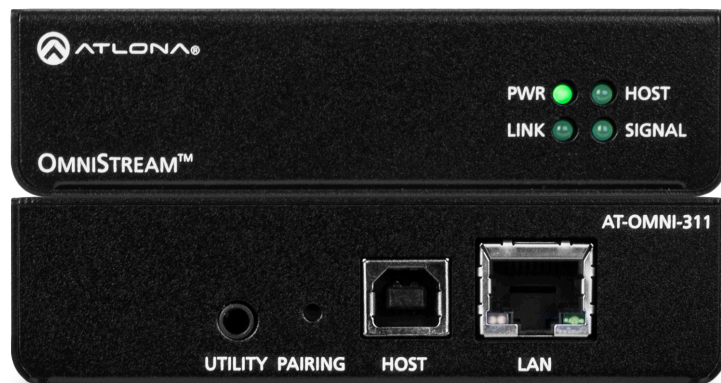

Version Information

Version	Release Date	Notes
1	Apr 2018	Initial release
2	Oct 2021	Updated format

Sales, Marketing, and Customer Support

Main Office

Atlona Incorporated
70 Daggett Drive
San Jose, CA 95134
United States

Office: +1.877.536.3976 (US Toll-free)
Office: +1.408.962.0515 (US/International)

Sales and Customer Service Hours
Monday - Friday: 6:00 a.m. - 4:30 p.m. (PST)

<http://www.atlona.com/>

International Headquarters

Atlona International AG
Tödistrasse 18
8002 Zürich
Switzerland

Office: +41 43 508 4321

Sales and Customer Service Hours
Monday - Friday: 09:00 - 17:00 (UTC +1)

Operating Notes



IMPORTANT: Visit <http://www.atlona.com/product/AT-OMNI-311> for the latest firmware updates and User Manual.

Atlona, Inc. (“Atlona”) Limited Product Warranty

Coverage

Atlona warrants its products will substantially perform to their published specifications and will be free from defects in materials and workmanship under normal use, conditions and service.

Under its Limited Product Warranty, Atlona, at its sole discretion, will either:

- repair or facilitate the repair of defective products within a reasonable period of time, restore products to their proper operating condition and return defective products free of any charge for necessary parts, labor and shipping.

OR

- replace and return, free of charge, any defective products with direct replacement or with similar products deemed by Atlona to perform substantially the same function as the original products.

OR

- refund the pro-rated value based on the remaining term of the warranty period, not to exceed MSRP, in cases where products are beyond repair and/or no direct or substantially similar replacement products exist.

Repair, replacement or refund of Atlona products is the purchaser’s exclusive remedy and Atlona liability does not extend to any other damages, incidental, consequential or otherwise.

This Limited Product Warranty extends to the original end-user purchaser of Atlona products and is non-transferrable to any subsequent purchaser(s) or owner(s) of these products.

Coverage Periods

Atlona Limited Product Warranty Period begins on the date of purchase by the end-purchaser. The date contained on the end-purchaser’s sales or delivery receipt is the proof purchase date.

Limited Product Warranty Terms – New Products

- 10 years from proof of purchase date for hardware/electronics products purchased on or after June 1, 2013.
- 3 years from proof of purchase date for hardware/electronics products purchased before June 1, 2013.
- Lifetime Limited Product Warranty for all cable products.

Limited Product Warranty Terms – Refurbished (B-Stock) Products and Discontinued Products

- 3 years from proof of purchase date for all Refurbished (B-Stock) and Discontinued hardware and electronic products purchased on or after June 1, 2013.

Remedy

Atlona recommends that end-purchasers contact their authorized Atlona dealer or reseller from whom they purchased their products. Atlona can also be contacted directly. Visit atlona.com for Atlona’s contact information and hours of operation. Atlona requires that a dated sales or delivery receipt from an authorized dealer, reseller or end-purchaser is provided before Atlona extends its warranty services. Additionally, a return merchandise authorization (RMA) and/or case number, is required to be obtained from Atlona in advance of returns.

Atlona requires that products returned are properly packed, preferably in the original carton, for shipping. Cartons not bearing a return authorization or case number will be refused. Atlona, at its sole discretion, reserves the right to reject any products received without advanced authorization. Authorizations can be requested by calling 1-877-536-3976 (US toll free) or 1-408- 962-0515 (US/international) or via Atlona’s website at atlona.com.

Exclusions

This Limited Product Warranty excludes:

- Damage, deterioration or malfunction caused by any alteration, modification, improper use, neglect, improper packaging or shipping (such claims must be presented to the carrier), lightning, power surges, or other acts of nature.

Atlona, Inc. (“Atlona”) Limited Product Warranty

- Damage, deterioration or malfunction resulting from the installation or removal of this product from any installation, any unauthorized tampering with this product, any repairs attempted by anyone unauthorized by Atlona to make such repairs, or any other cause which does not relate directly to a defect in materials and/or workmanship of this product.
- Equipment enclosures, cables, power supplies, batteries, LCD displays, and any accessories used in conjunction with the product(s).
- Products purchased from unauthorized distributors, dealers, resellers, auction websites and similar unauthorized channels of distribution.

Disclaimers

This Limited Product Warranty does not imply that the electronic components contained within Atlona’s products will not become obsolete nor does it imply Atlona products or their electronic components will remain compatible with any other current product, technology or any future products or technologies in which Atlona’s products may be used in conjunction with. Atlona, at its sole discretion, reserves the right not to extend its warranty offering in instances arising outside its normal course of business including, but not limited to, damage inflicted to its products from acts of god.

Limitation on Liability

The maximum liability of Atlona under this limited product warranty shall not exceed the original Atlona MSRP for its products. To the maximum extent permitted by law, Atlona is not responsible for the direct, special, incidental or consequential damages resulting from any breach of warranty or condition, or under any other legal theory. Some countries, districts or states do not allow the exclusion or limitation of relief, special, incidental, consequential or indirect damages, or the limitation of liability to specified amounts, so the above limitations or exclusions may not apply to you.

Exclusive Remedy

To the maximum extent permitted by law, this limited product warranty and the remedies set forth above are exclusive and in lieu of all other warranties, remedies and conditions, whether oral or written, express or implied. To the maximum extent permitted by law, Atlona specifically disclaims all implied warranties, including, without limitation, warranties of merchantability and fitness for a particular purpose. If Atlona cannot lawfully disclaim or exclude implied warranties under applicable law, then all implied warranties covering its products including warranties of merchantability and fitness for a particular purpose, shall provide to its products under applicable law. If any product to which this limited warranty applies is a “Consumer Product” under the Magnuson-Moss Warranty Act (15 U.S.C.A. §2301, ET SEQ.) or other applicable law, the foregoing disclaimer of implied warranties shall not apply, and all implied warranties on its products, including warranties of merchantability and fitness for the particular purpose, shall apply as provided under applicable law.

Other Conditions

Atlona’s Limited Product Warranty offering gives legal rights, and other rights may apply and vary from country to country or state to state. This limited warranty is void if (i) the label bearing the serial number of products have been removed or defaced, (ii) products are not purchased from an authorized Atlona dealer or reseller. A comprehensive list of Atlona’s authorized distributors, dealers and resellers can be found at www.atlona.com.

Important Safety Information

CAUTION
 RISK OF ELECTRIC SHOCK
 DO NOT OPEN

CAUTION: TO REDUCE THE RISK OF
 ELECTRIC SHOCK
 DO NOT OPEN ENCLOSURE OR EXPOSE
 TO RAIN OR MOISTURE.
 NO USER-SERVICEABLE PARTS
 INSIDE REFER SERVICING TO
 QUALIFIED SERVICE PERSONNEL.



The exclamation point within an equilateral triangle is intended to alert the user to the presence of important operating and maintenance instructions in the literature accompanying the product.



The information bubble is intended to alert the user to helpful or optional operational instructions in the literature accompanying the product.

1. Read these instructions.
2. Keep these instructions.
3. Heed all warnings.
4. Follow all instructions.
5. Do not use this product near water.
6. Clean only with a dry cloth.
7. Do not block any ventilation openings. Install in accordance with the manufacturer's instructions.
8. Do not install or place this product near any heat sources such as radiators, heat registers, stoves, or other apparatus (including amplifiers) that produce heat.
9. Do not defeat the safety purpose of a polarized or grounding-type plug. A polarized plug has two blades with one wider than the other. A grounding type plug has two blades and a third grounding prong. The wide blade or the third prong are provided for your safety. If the provided plug does not fit into your outlet, consult an electrician for replacement of the obsolete outlet.
10. Protect the power cord from being walked on or pinched particularly at plugs, convenience receptacles, and the point where they exit from the product.
11. Only use attachments/accessories specified by Atlona.
12. To reduce the risk of electric shock and/or damage to this product, never handle or touch this unit or power cord if your hands are wet or damp. Do not expose this product to rain or moisture.
13. Unplug this product during lightning storms or when unused for long periods of time.
14. Refer all servicing to qualified service personnel. Servicing is required when the product has been damaged in any way, such as power-supply cord or plug is damaged, liquid has been spilled or objects have fallen into the product, the product has been exposed to rain or moisture, does not operate normally, or has been dropped.



FCC Compliance

FCC Compliance and Advisory Statement: This hardware device complies with Part 15 of the FCC rules. Operation is subject to the following two conditions: 1) this device may not cause harmful interference, and 2) this device must accept any interference received including interference that may cause undesired operation. This equipment has been tested and found to comply with the limits for a Class A digital device, pursuant to Part 15 of the FCC Rules. These limits are designed to provide reasonable protection against harmful interference in a commercial installation. This equipment generates, uses, and can radiate radio frequency energy and, if not installed or used in accordance with the instructions, may cause harmful interference to radio communications. However there is no guarantee that interference will not occur in a particular installation. If this equipment does cause harmful interference to radio or television reception, which can be determined by turning the equipment off and on, the user is encouraged to try to correct the interference by one or more of the following measures: 1) reorient or relocate the receiving antenna; 2) increase the separation between the equipment and the receiver; 3) connect the equipment to an outlet on a circuit different from that to which the receiver is connected; 4) consult the dealer or an experienced radio/TV technician for help. Any changes or modifications not expressly approved by the party responsible for compliance could void the user's authority to operate the equipment. Where shielded interface cables have been provided with the product or specified additional components or accessories elsewhere defined to be used with the installation of the product, they must be used in order to ensure compliance with FCC regulations.

Copyright, Trademark, and Registration

© 2021 Atlona Inc. All rights reserved. "Atlona" and the Atlona logo are registered trademarks of Atlona Inc. Pricing, specifications and availability subject to change without notice. Actual products, product images, and online product images may vary from images shown here.

All other trademark(s), copyright(s), and registered technologies mentioned in this document are the properties of their respective owner(s).

Table of Contents

Introduction	8
Features	8
Package Contents	8
Panel Description	9
Installation	10
Connection Instructions	10
Over a Network	10
Direct Connection	10
Connection Diagrams	11
Basic Operation	12
LED Indicators	12
Pairing	13
Using AMS	13
Manual Pairing	16
Unpairing an Extender	16
Using Velocity™	17
DHCP Reset	25
The AMS Interface	26
Device Info tab	26
Network tab	27
Pairing tab	28
Appendix	29
Specifications	29

Introduction

The Atlona OmniStream™ USB 311 (**AT-OMNI-311**) works in tandem with the OmniStream USB 324 (AT-OMNI-324) for extending USB from peripheral devices to a PC over Gigabit Ethernet. The OmniStream USB 311 interfaces with a PC or other host device, while the OmniStream USB 324 features a four-port USB hub for peripherals. The OmniStream USB over IP system is compatible with USB 2.0 data rates of up to 480 Mbps. It can be used with high-bandwidth devices including cameras, speaker phones, microphones, and DSPs, plus standard USB HID class devices such as a keyboard, mouse, or touch display. Up to seven OmniStream USB 324 units can be simultaneously paired to an OmniStream USB 311. Additionally, USB routing over the network can be managed using Atlona Management System (AMS) 2.0.

OmniStream USB products can be used in a wide variety of system design scenarios for soft codec conferencing and remote keyboard / mouse control. They are ideal for integrating USB audio and video devices as part of a fully IP-based meeting room system, in conjunction with OmniStream AV over IP devices and the Velocity Control System.

Features

- Extend USB over Gigabit Ethernet using CAT5e/6 cable
- USB host connection for PC
- Compatible with USB 2.0 data rates up to 480 Mbps
- Ideal for meeting room applications to extend USB from touch displays, cameras, speakerphones, DSPs, and more
- Design flexible and scalable AV systems in combination with OmniStream AV encoders and decoders
- Pairs simultaneously with up to seven OmniStream 324 units over a network
- USB signal routing configured and managed by AMS 2.0 (Atlona Management System)
- Ready for integration with Atlona Velocity™ Control System to manage USB signal routing
- Front panel LED indicators for power, network and USB host connectivity, and USB signal presence over IP
- Low-profile, 1 inch (25 mm) high enclosure
- Powered directly by the USB host device
- Includes installation guide and surface mounting brackets
- Award-winning 10 year limited product warranty

Package Contents

1 x AT-OMNI-311
2 x Mounting brackets
1 x Installation Guide

Panel Description

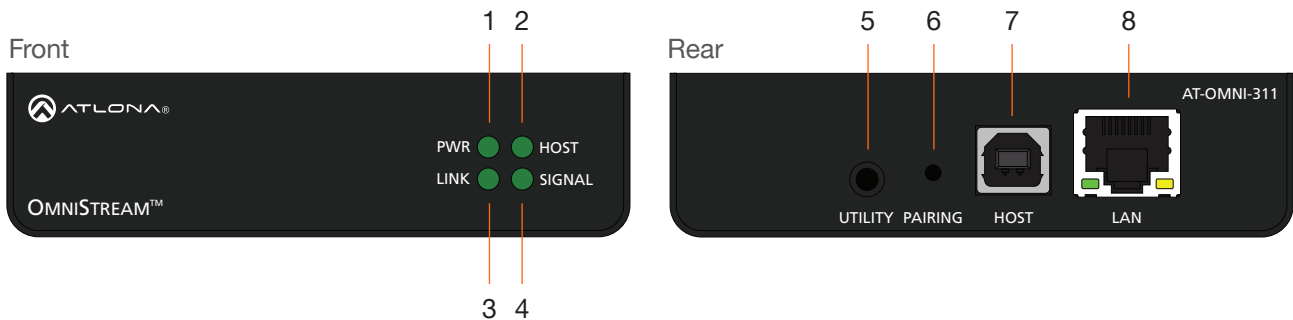

- 1 PWR**
 This LED indicator glows solid green when the unit is powered. This unit is powered by the host device using USB. No external power supply is required. Refer to [LED Indicators \(page 12\)](#) for more information.
- 2 HOST**
 This LED indicator glows green when a USB host device is connected to the unit. Refer to [LED Indicators \(page 12\)](#) for more information.
- 3 LINK**
 This LED indicator is solid green when a solid connection between this unit and the receiver has been established. Refer to [LED Indicators \(page 12\)](#) for more information.
- 4 SIGNAL**
 This LED indicator monitors data transmission between this unit and the receiver. The LED will blink intermittently whether or not a USB device is connected. Refer to [LED Indicators \(page 12\)](#) for more information.
- 5 UTILITY**
 This port is for factory programming.
- 6 PAIRING**
 Press this button to begin the pairing process.
- 7 HOST**
 Connect a USB type-B connector from this port to the host computer.
- 8 LAN**
 Connect an Ethernet cable from this port to the Local Area Network (LAN).

Installation

Connection Instructions



IMPORTANT: The AT-OMNI-324 supports a maximum of 3 additional USB hubs that may be connected downstream. Up to 7 AT-OMNI-324 units may be paired to an AT-OMNI-311, allowing up to a maximum of 31 USB devices.

1. Place the AT-OMNI-311 next to the USB host device and connect a USB cable from the **HOST** port to the host computer.

The AT-OMNI-311 can be connect to a AT-OMNI-324 (not included) in one of two ways:

Over a Network

- a. Connect an Ethernet cable, up to 330 feet (100 meters), from the **LAN** port on the AT-OMNI-311 to the network switch.
- b. Connect an Ethernet cable, up to 330 feet (100 meters), from the receiver (AT-OMNI-324; not included) to a switch on the same network.



NOTE: When connecting a transmitter and receiver, over a network, the cable distance between hops must not exceed 330 feet (100 meters) for copper connections (fiber extenders can be used to create longer runs). For example, connecting up to five network switches, using copper cabling, can be used to extend USB up to 1980 feet (600 meters).

Direct Connection

- a. Connect an Ethernet cable, up to 330 feet (100 meters), from the LAN port of the AT-OMNI-311 directly to the AT-OMNI-324 (not included).
2. The AT-OMNI-311 is powered by the host computer. No external power supply is required.
 3. Refer to [Pairing \(page 13\)](#) for instructions on pairing.

Connection Diagrams

Connection over a Local Area Network (LAN)

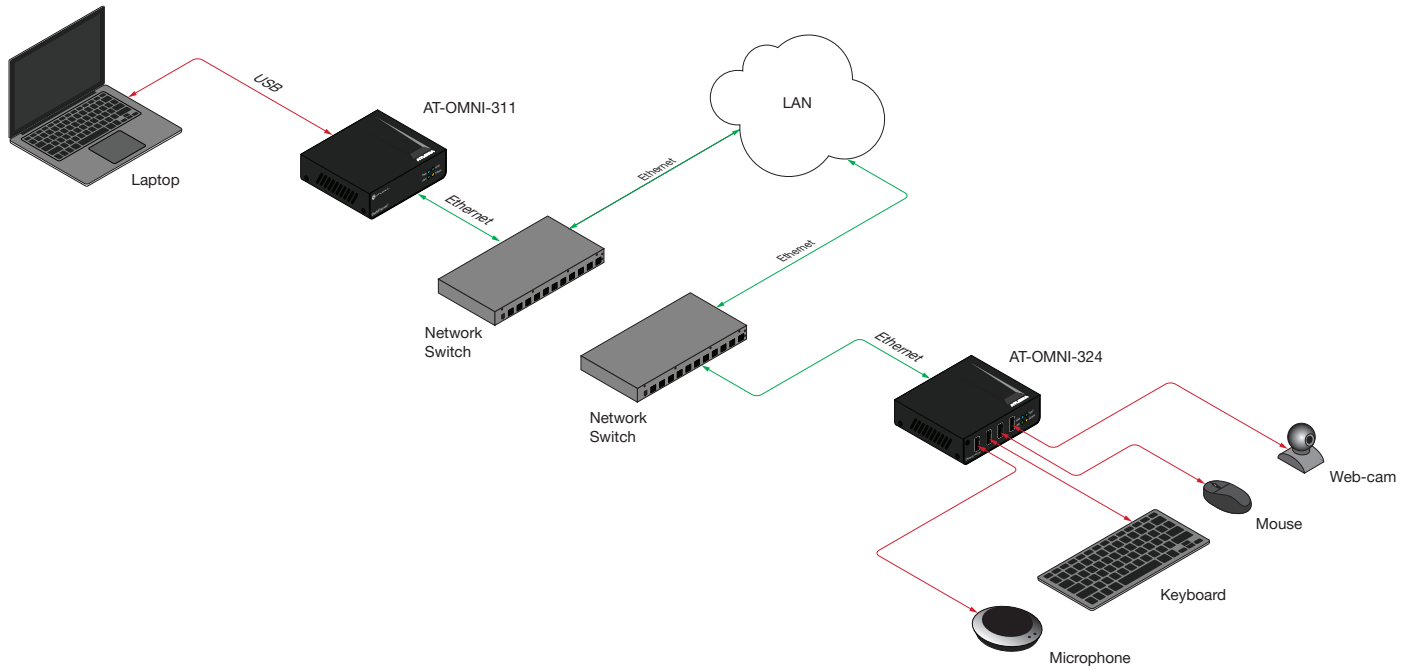



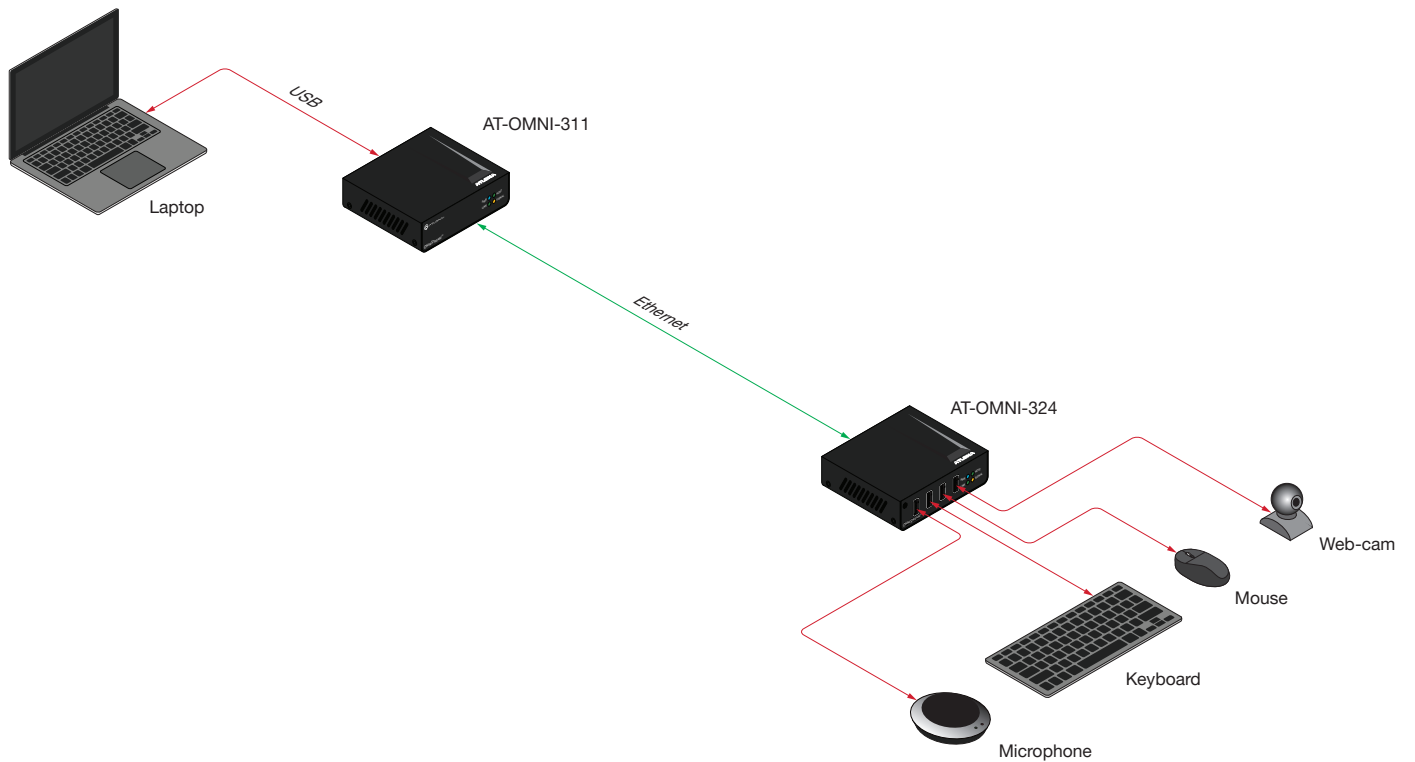







Direct Connection



Basic Operation

LED Indicators

The **PWR**, **LINK**, **HOST**, and **SIGNAL** LED indicators on the OmniStream 311 provide basic information on the current status of the unit.

LED		Description
PWR	Solid green 	Unit is powered.
	Off 	Unit is not powered. <ul style="list-style-type: none"> Verify that a USB Type-B cable is connected from the HOST port to the host computer.
LINK	Solid green 	The link integrity between the transmitter and the receiver is good.
	Blinking green (slow) 	The transmitter is attempting to establish a link to the receiver.
	Blinking green (fast) 	The transmitter is in Pairing Mode.
	Off 	There is no link between the transmitter and the receiver. <ul style="list-style-type: none"> Direct Mode: Verify that an Ethernet cable is connected between the LAN port on the transmitter and the receiver. Network Mode: Verify that an Ethernet cable is connected between the LAN port on the transmitter and the network switch. Check that the Ethernet cable is not physically damaged. Make sure that the Ethernet cable does not exceed 330 feet (100 meters).
HOST	Solid green 	The transmitter is properly enumerated on the host computer.
	Blinking green 	The transmitter is in a suspended state.
SIGNAL	Blinking green 	This LED indicator will blink intermittently when data is being transmitted between the transmitter and the receiver.
	Off 	The transmitter is in Suspend Mode.

Pairing

Pairing an OmniStream 311 to a OmniStream 324 (not included) is managed using the Atlona Management System (AMS). AMS is free and can be downloaded from <https://atlona.com/AMS>. The pairing process can also be performed using the Server Appliance for Atalona Management System (AT-AMS-HW).

Using AMS

1. Launch a web browser and enter the IP address of AMS, in the address bar.
2. Enter the required login credentials.

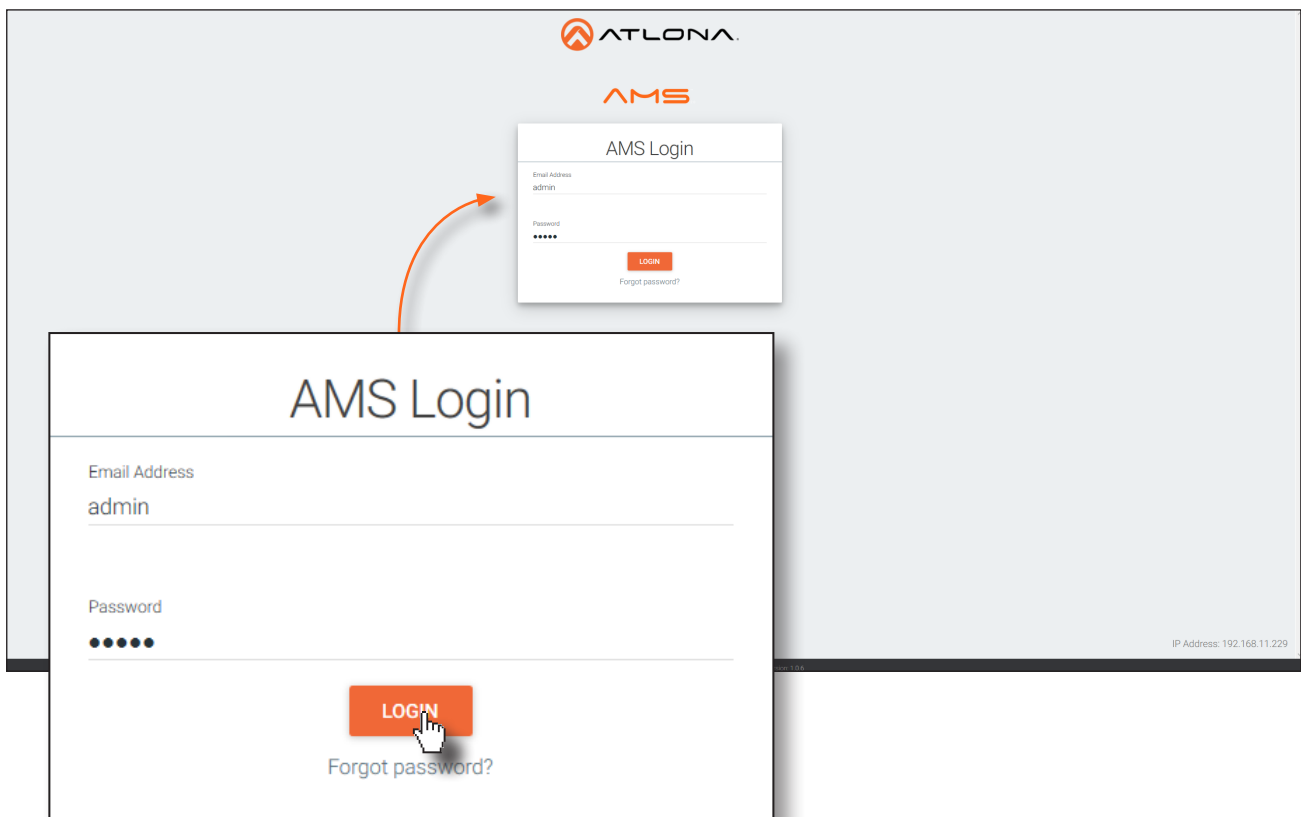

3. Click the **Login** button.
4. The AMS Dashboard will be displayed.
5. Click the  icon, in the upper-left corner of the AMS Dashboard.
6. Click **Devices > Unassigned** from the fly-out menu.

All available OmniStream 311 devices will be displayed under the **Unassigned** category. When a device is unassigned, it means that the device has not yet been assigned to a site, building, and/or room. Refer to the AMS User Manual for more information on these topics.

- Click one of the drop-down lists and select the desired OmniStream 324. In this example, only a single OmniStream 324 is connected to the network. Therefore, this is the only available option.

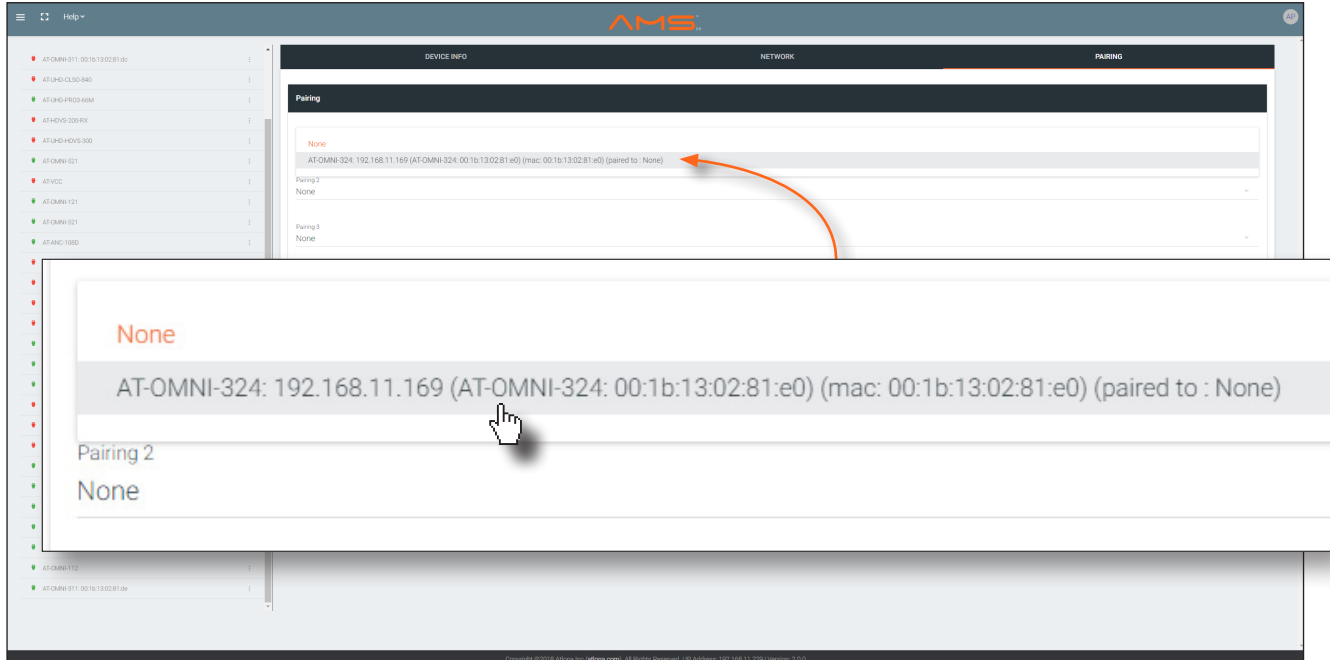

- Click the **SAVE** button at the bottom of the page.
- The pairing process is complete. Repeat steps 7 through 10 for each OmniStream 311 on the network.

To unpair an OmniStream 311 from a OmniStream 324, select **None** from the drop-down list and then click the **SAVE** button.

Manual Pairing

The OmniStream 311 and OmniStream 324 can also be paired manually. This applies when the OmniStream 311 and OmniStream 324 are connected, either through a network switch (on the same broadcast domain) or directly to one another using category cable. This instructions below cover manual pairing for both the OmniStream 311 and OmniStream 324.

1. Make sure both the OmniStream 311 and OmniStream 324 are connected, either directly or through a network switch, and that all USB connections have been made.

OmniStream 311

2. Press and hold the **PAIRING** button, for no more than 10 seconds, on the OmniStream 311 using the end of a paperclip or other pointed object.



IMPORTANT: Pressing the **PAIRING** button for *more* than 10 seconds will cancel the pairing mode.

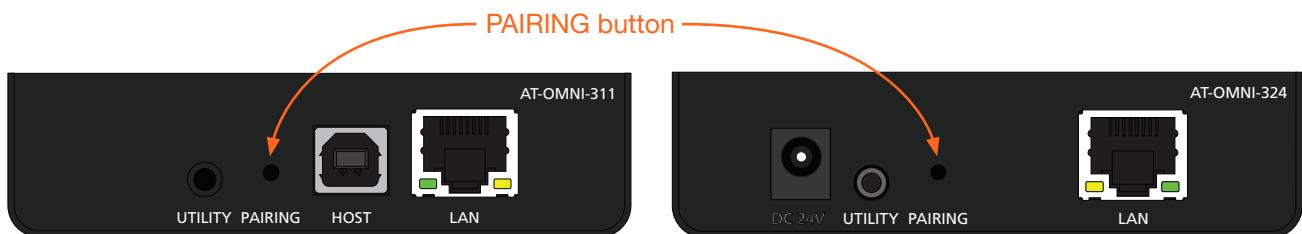

3. Release the **PAIRING** button. The **LINK** LED indicator will begin flashing. Pairing mode is now active on the OmniStream 311.



NOTE: To cancel pairing mode, press and hold the **PAIRING** button for more than 10 seconds.

OmniStream 324

4. Press and hold the **PAIRING** button on the OmniStream 324, for *no more* than 10 seconds, using the end of a paperclip or other pointed object.



IMPORTANT: Pressing the **PAIRING** button for *more* than 10 seconds will cancel the pairing mode. The **PAIRING** button on the OmniStream 324 must be pressed within 10 minutes of activating pairing mode on the OmniStream 311. If not, then the pairing process will automatically be cancelled.

5. Release the **PAIRING** button. The **LINK** LED indicator will begin flashing. Pairing mode is now active on the OmniStream 324.

The OmniStream 311 and OmniStream 324 will begin the linking process. During the linking process, the **LINK** LED indicator on both unit may flash more slowly. This is normal behavior.

Once both **LINK** LED indicators are solid green, the pairing process will be complete.

Unpairing an Extender

To unpair one extender from the other, press and hold the **PAIRING** button, on either of the connected units, for *more* than 10 seconds, then release.

Using Velocity™

The following section provides instructions on pairing AT-OMNI-311 units with AT-OMNI-324 units using the Atlona Velocity Control Software. Familiarity with the Velocity software is assumed. Refer to the *Atlona Velocity User Manual* for more information, if necessary.

1. Launch a web browser and enter the IP address of Velocity, in the address bar.
2. Enter the required login credentials.
3. Click the **Login** button.
4. The Velocity Dashboard will be displayed.
5. Click the ☰ icon, in the upper-left corner, to display the fly-out menu.

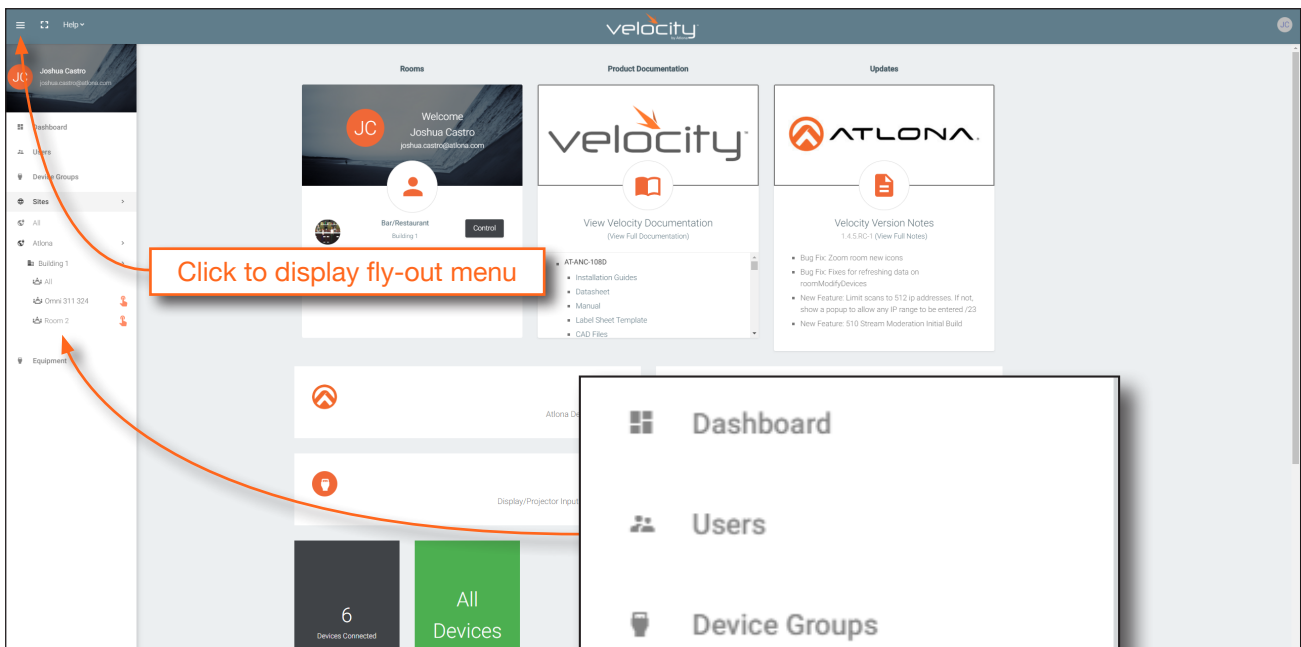

6. Click **Sites** in the menu bar to expand the list of buildings and rooms.
7. Click the desired room from the list.

In the example on the right, a set of units have been set up in a room called **Omni 311 324** within **Building 1**.

Refer to the *Velocity User Manual* for instructions on creating rooms and adding devices to rooms.

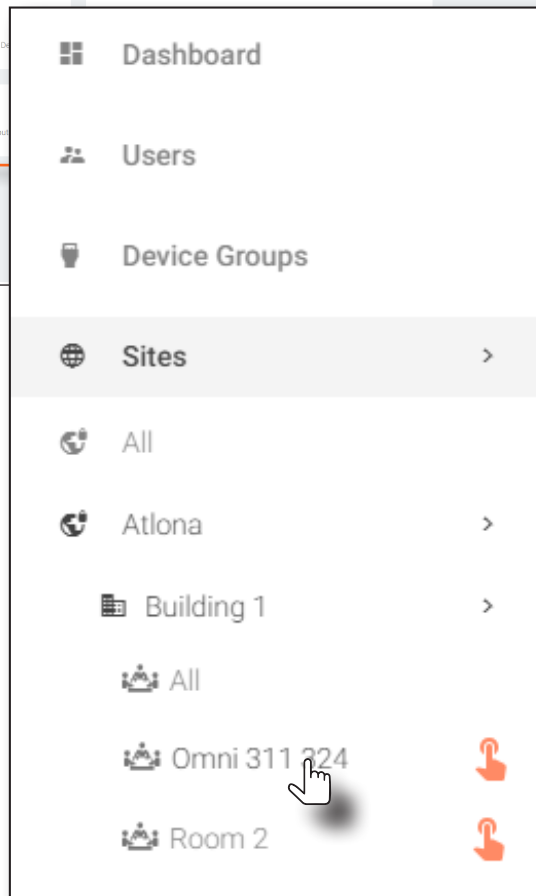

- The **Modify Room** screen will be displayed. Click the **Room Control Options** icon, in the upper-right corner of the **Technology** bar.

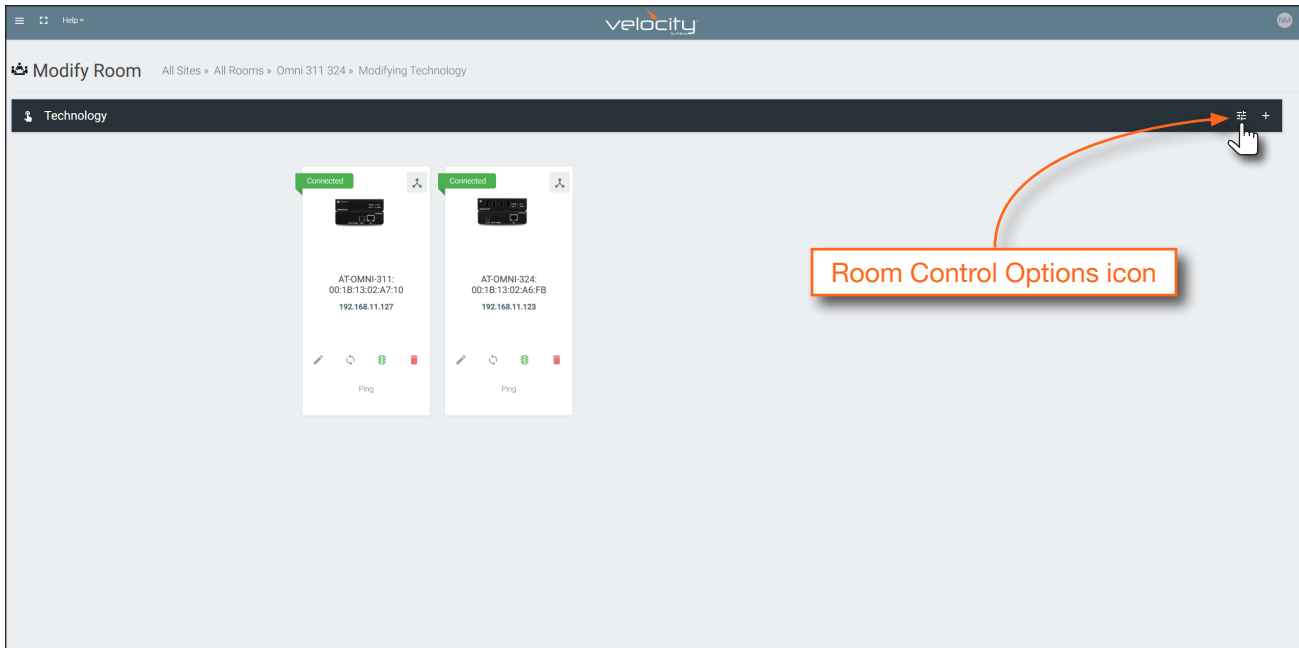

- The **Room Control Options** screen will be displayed. In order to allow units to be paired or unpaired, two macros will need be created: one for pairing and one for unpairing.

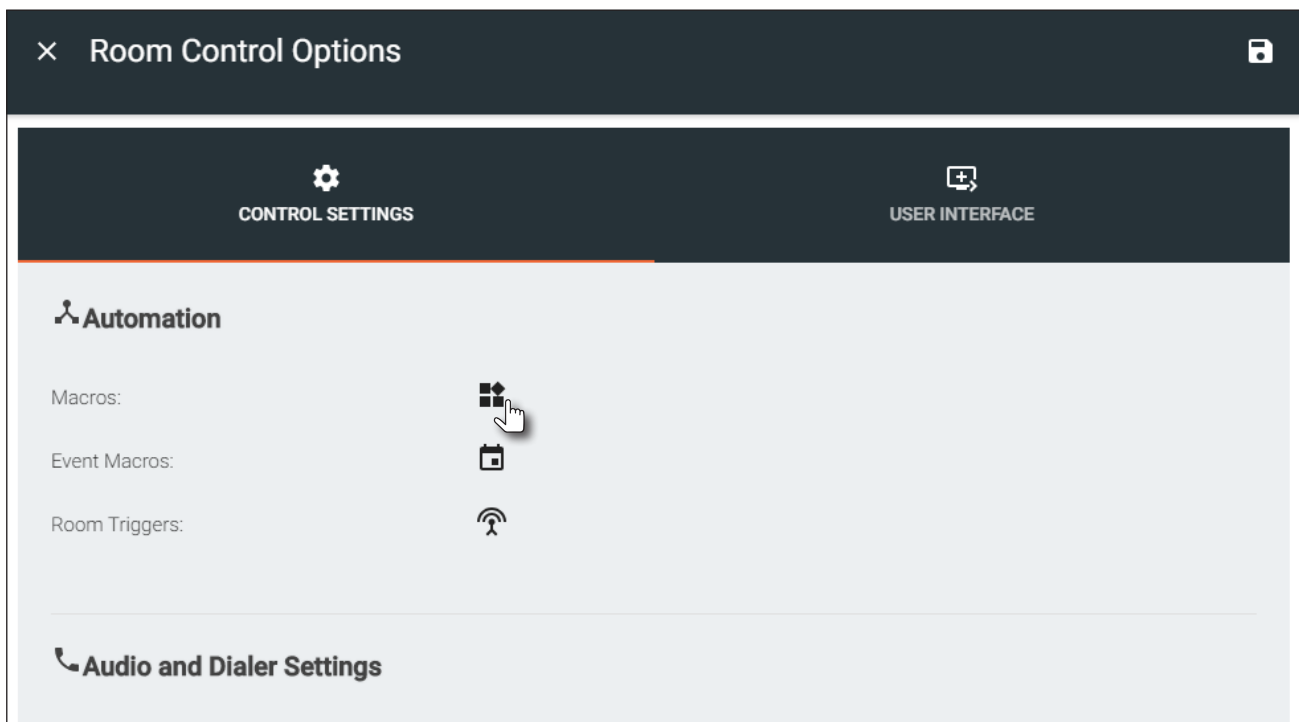

- Click the **Macros** icon to display the **Room Macros** screen.

Creating the Unpair Macro

1. In the **Room Macros** screen, click the **+** icon, in the upper-right corner of the screen.

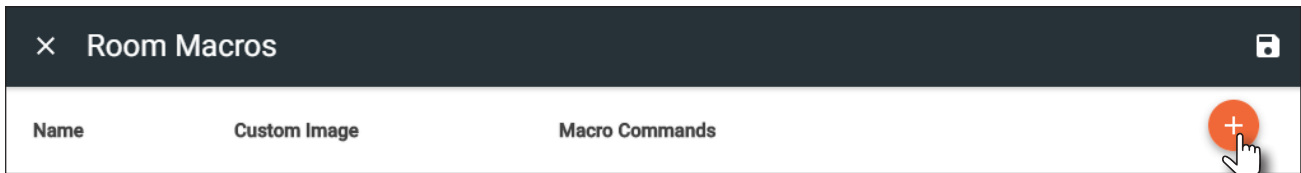

2. Enter the name of the macro in both the **Name** and **Macro Commands** text field. The name of the macro should be descriptive of what option is being performed.
3. Click the **+** icon to display the macro configuration dialog.



4. Click the **Device** drop-down list and select one of the device from this list. Since the “Unpair” macro will disconnect the two units from one another, either the AT-OMNI-311 or AT-OMNI-324 can be selected from this drop-down list. In this example, the AT-OMNI-324 is selected.

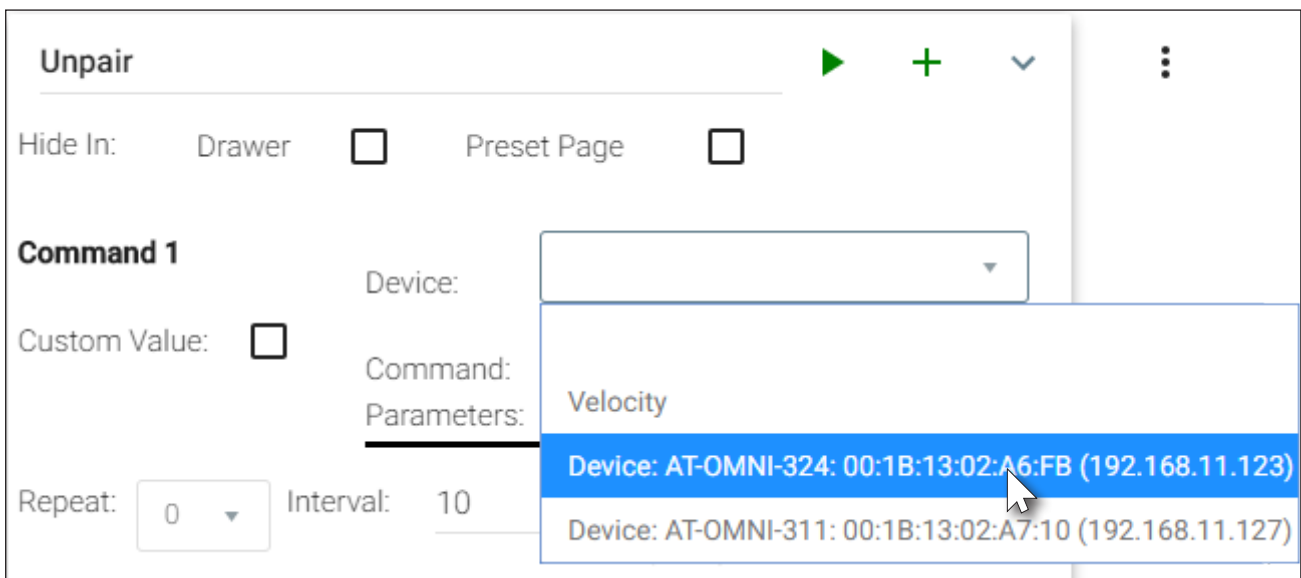

5. Click the **Command** drop-down list and select **Remove All Pairings**.
6. Repeat steps 3 through 5: when repeating these steps, select the AT-OMNI-311 from the **Device** drop-down list.
7. Click the **Save** icon in the top-right portion of the **Room Macros** bar.

Creating the Pair Macro

1. In the **Room Macros** screen, click the **+** icon, in the upper-right corner of the screen.

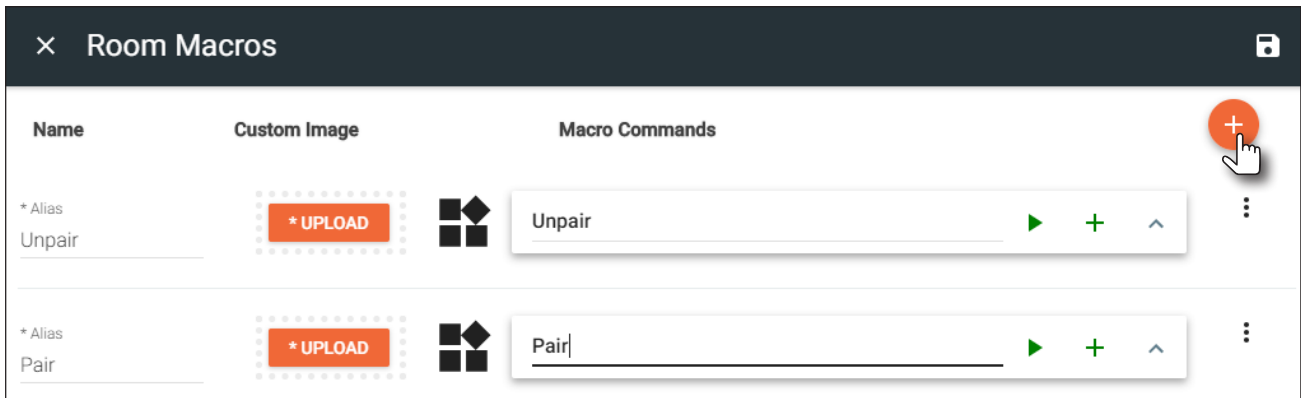

2. Enter the name of the macro in both the **Name** and **Macro Commands** text field. In this example, "Pair" will be used.
3. Click the **+** icon to display the macro configuration dialog.
4. Click the **Device** drop-down list and select the AT-OMNI-324.
5. Click the **Command** drop-down list and select **Pair (Auto)**.
6. Click the second **Device** drop-down list and select the unit to be paired. Since the AT-OMNI-324 was already selected, select the AT-OMNI-311 from the drop-down list.

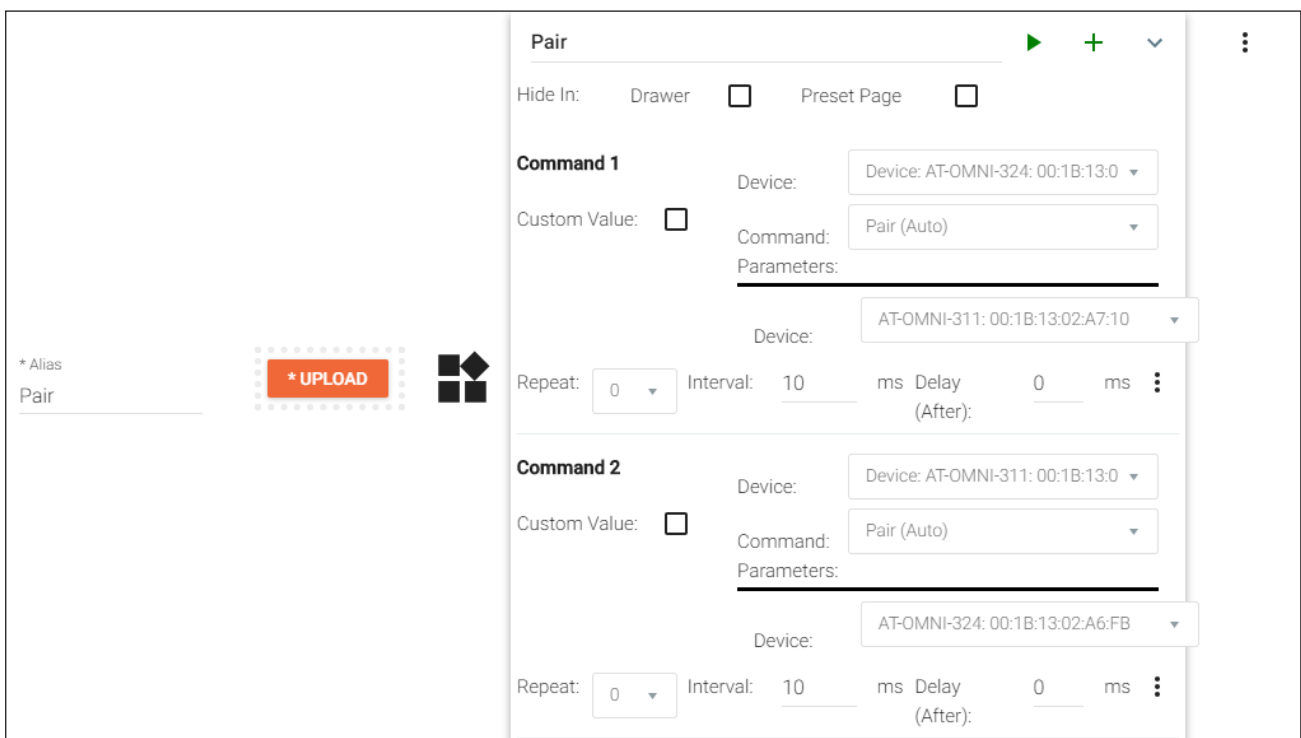

7. Repeat steps 2 through 5: For the first **Device** drop-down list, select the AT-OMNI-324, and for the second **Device** drop-down list, select the AT-OMNI-311. When this macro is completed, it should appear similar to the following:
8. Click the **Save** icon, in the top-right portion of the **Room Macros** bar.

Pairing and Unpairing Units

IMPORTANT: Before pairing units, make sure to unpair (remove) any existing pairings using the “unpair” macro that was created on page 19.

1. Click the ▶ icon for the “Unpair” macro. This will remove any possible “out-of-the-box” (factory) pairing that may exist.
2. Click the ▶ icon for the “Pair” macro to pair the two units.

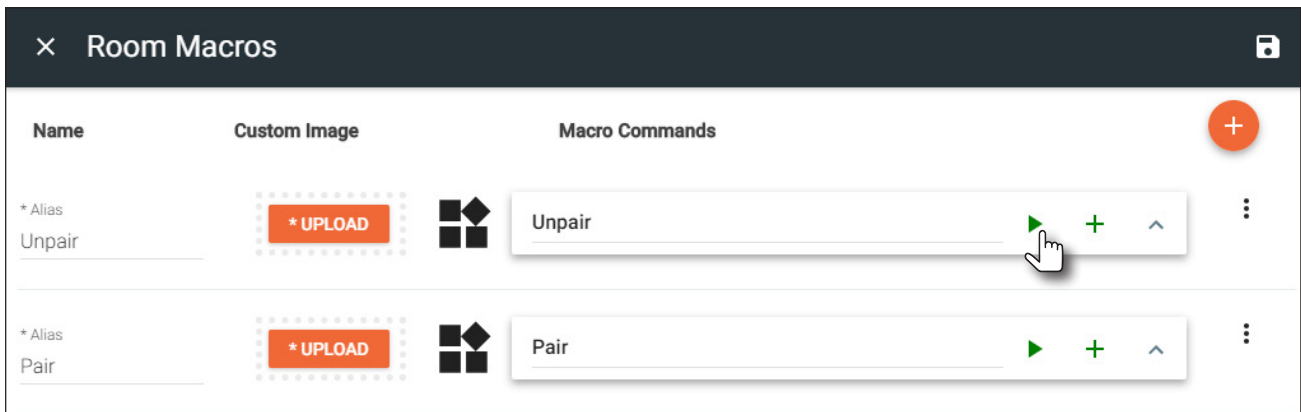

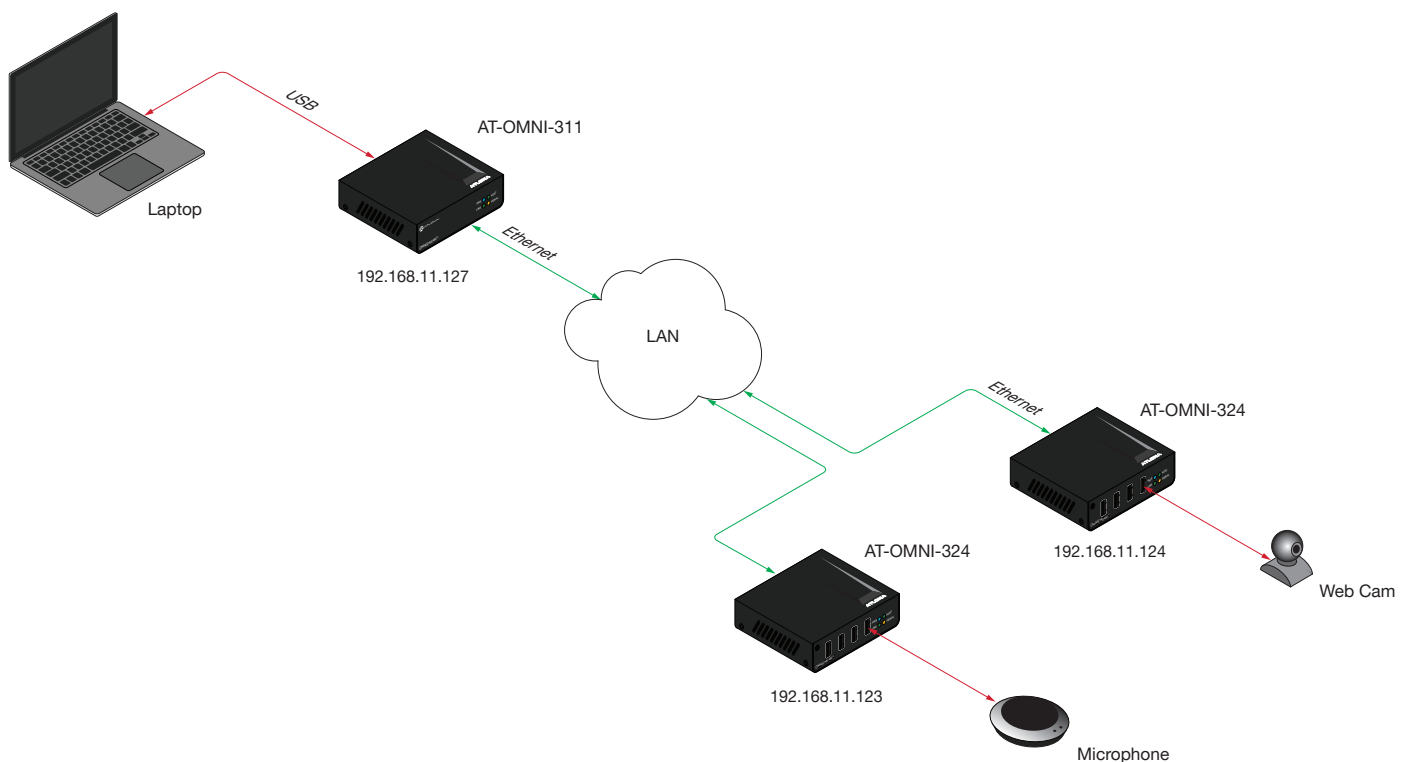

Example: Pairing two AT-OMNI-324 to a single AT-OMNI-311

The following illustration depicts an example of how to pair two AT-OMNI-324 units to a single AT-OMNI-311. Refer to the instructions on the following page for how to configure this setup. Note that arbitrary IP addresses have been assigned for reference.



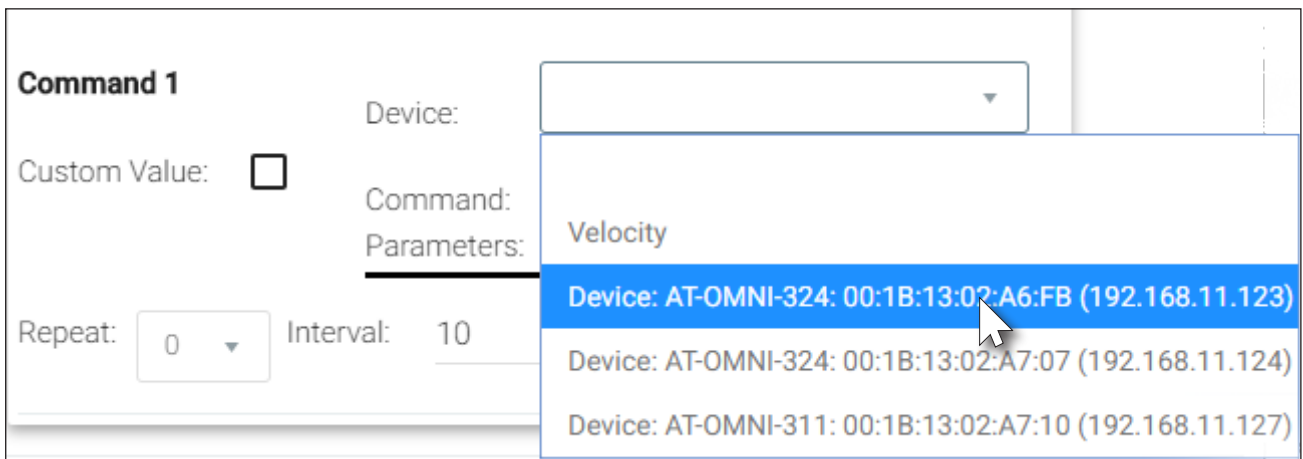

Basic Operation

1. In the **Room Macros** screen, click the  icon, in the upper-right corner of the screen.
2. Enter “Unpair” for both the **Name** and **Macro Commands** text field.
3. Click the  icon to display the macro configuration dialog.
4. Click the **Device** drop-down list and select one of the devices from this list. Since the “Unpair” macro will be disconnecting a total of three units from one another, the “Unpair” macro will contain a total of three commands. In this example, the AT-OMNI-324 is arbitrarily selected.

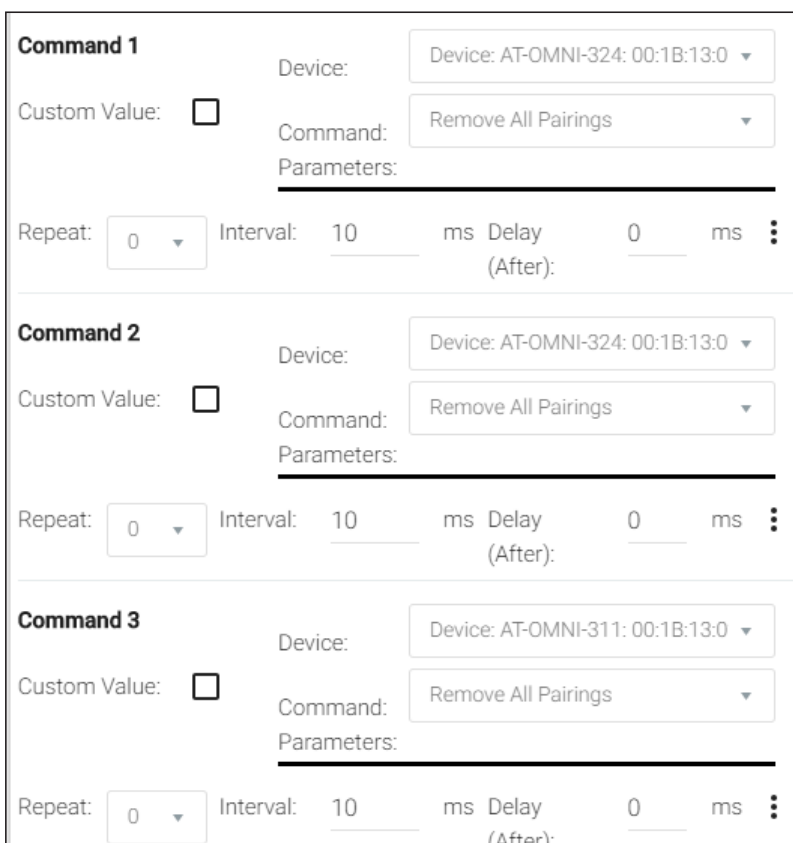

5. Click the **Command** drop-down list and select **Remove All Pairings**.
6. Repeat steps 3 through 5, selecting the second AT-OMNI-324 and then the AT-OMNI-311 from the **Device** drop-down list. When completed, the “Unpair” macro should appear as follows:



7. Click the **Save** icon in the top-right portion of the **Room Macros** bar.
8. Create a “pairing” macro by clicking the  icon, in the upper-right corner of the screen.

Note that since there are two AT-OMNI-324 units, creating the “Pair” macro can be achieved using two different methods:

- a. Create two separate macros: one to pair the AT-OMNI-311 and the AT-OMNI-324 with the camera, and another one to pair the AT-OMNI-311 with the AT-OMNI-324 with the speakerphone. This method provides more control, providing the option of which AT-OMNI-324 is paired with the AT-OMNI-311.
- b. Create a single macro which pairs both AT-OMNI-324 units to the AT-OMNI-311. This method is more convenient, but does not provide the option of which AT-OMNI-324 is paired with the AT-OMNI-311.

For this example, two separate pairing macros will be created:

9. Enter “Pair to camera” in both the **Name** and **Macro Commands** text field. This macro will be used to pair the computer with the camera.
10. Click the  icon to display the macro configuration dialog.
11. Click the **Device** drop-down list and select the AT-OMNI-324 that is connected to the camera. In this example, the AT-OMNI-324 with the IP address of 192.168.11.124 will be selected.
12. Click the **Command** drop-down list and select **Pair (Auto)**.
13. Click the second **Device** drop-down list and select the AT-OMNI-311.
14. Repeat steps 10 through 13: select the AT-OMNI-311 in the first **Device** drop-down list, and then the AT-OMNI-324 with the camera, from the second **Device** drop-down list. The “Pair to camera” macro should now appear as follows:

Pair to camera ▶ + ▾

Hide In: Drawer Preset Page

Command 1

Custom Value:

Device:

Command:

Parameters:

Device:

Repeat: Interval: ms Delay ms ⋮

(After):

Command 2

Custom Value:

Device:



Command:

Parameters:

Device:

Repeat: Interval: ms Delay ms ⋮

(After):

15. Click the **Save** icon in the top-right portion of the **Room Macros** bar.
16. Click the  icon, in the upper-right corner of the screen to create the final macro. This macro will be used to pair the computer with the speakerphone.
17. Enter “Pair to speaker” in both the **Name** and **Macro Commands** text field.
18. Click the  icon to display the macro configuration dialog.
19. Click the **Device** drop-down list and select the AT-OMNI-324 that is connected to the speakerphone. The AT-OMNI-324 with the IP address of 192.168.11.123 will be selected
20. Click the **Command** drop-down list and select **Pair (Auto)**.
21. Click the second **Device** drop-down list and select the AT-OMNI-311.
22. Repeat steps 18 through 21: select the AT-OMNI-311 in the first **Device** drop-down list, and then the AT-OMNI-324 with the speakerphone, from the second **Device** drop-down list. The “Pair to speaker” macro should now appear as follows:

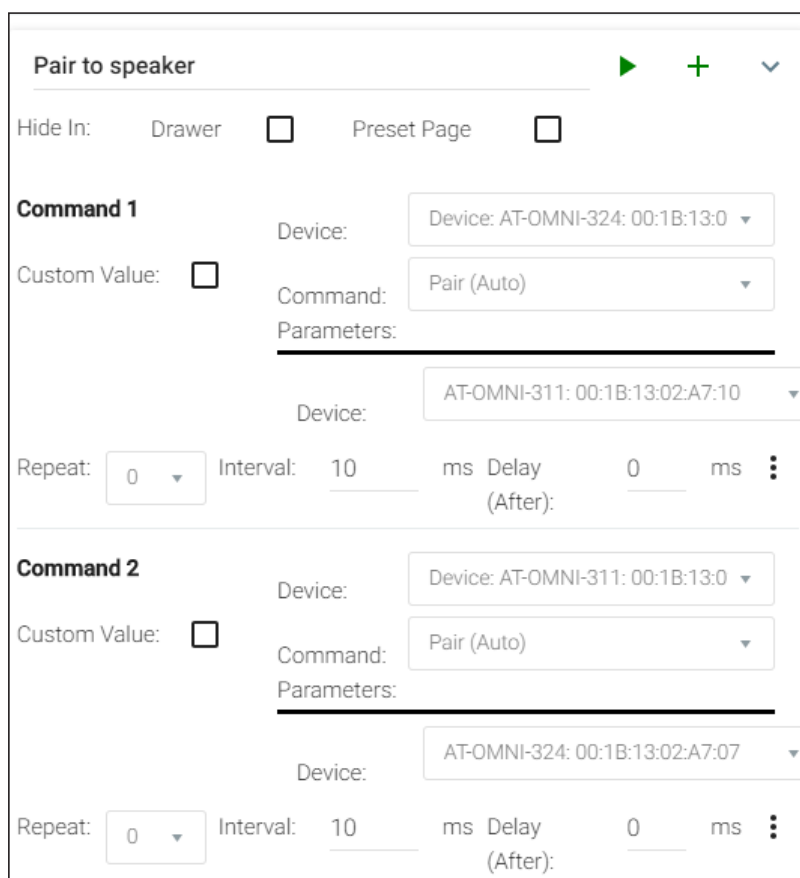

23. Click the **Save** icon in the top-right portion of the **Room Macros** bar.

DHCP Reset

Use the following instructions to reset the device to DHCP mode. Resetting to DHCP mode will not remove any pairings and if the device is already paired, it will remain paired.

1. Disconnect power from the unit.
2. Reconnect power to the unit, and within 5 seconds, press and hold the **PAIRING** button.



3. Continue holding the **PAIRING** button for 15 seconds, then release.
4. Power-cycle the unit once again, by disconnecting and reconnecting the power. Let the unit boot up normally.
5. The unit is now in DHCP mode and will automatically be assigned an IP address by the DHCP server, if one is present on the network.

The AMS Interface

Device Info tab

The **Device Info** tab provides general information about the OmniStream 311. The OmniStream 324 has an identical interface.

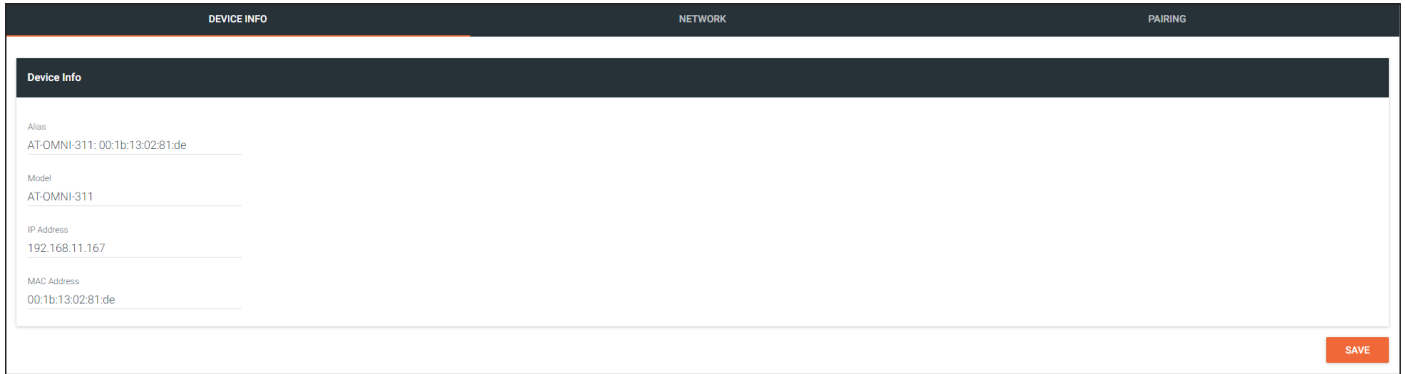

The screenshot shows the AMS interface with three tabs: DEVICE INFO, NETWORK, and PAIRING. The DEVICE INFO tab is active and displays the following information:

Field	Value
Alias	AT-OMNI-311:00:1b:13:02:81:de
Model	AT-OMNI-311
IP Address	192.168.11.167
MAC Address	00:1b:13:02:81:de

A **SAVE** button is located in the bottom right corner of the form.

Alias

Enter a name for the unit in this field. This is optional.

Model

The mode number of the unit.

IP Address

Displays the IP address of the unit.

MAC Address

Displays the MAC address of the unit.

Network tab

The **Network** tab provides the ability to enable or disable DHCP mode. When DHCP mode is disabled, the IP address, subnet mask, and gateway must be provided.

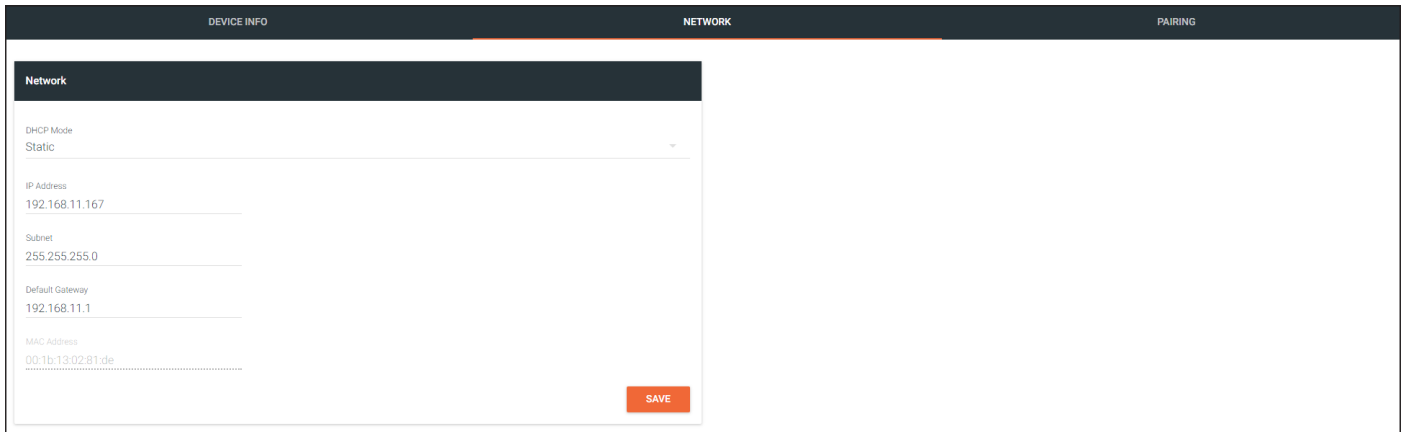

The screenshot shows the Network configuration page. At the top, there are three tabs: "DEVICE INFO", "NETWORK" (which is active), and "PAIRING". Below the tabs is a "Network" section with a dark header. The form contains the following fields:

- DHCP Mode: A dropdown menu currently set to "Static".
- IP Address: A text input field containing "192.168.11.167".
- Subnet: A text input field containing "255.255.255.0".
- Default Gateway: A text input field containing "192.168.11.1".
- MAC Address: A text input field containing "00:1b:13:02:81:de".

A "SAVE" button is located at the bottom right of the form.

DHCP Mode

Click this drop-down list to select the desired network mode. Select DHCP to let the DHCP server (if present) assign the encoder the IP settings; **Subnet** and **Gateway** fields will automatically be populated. When **Static** mode is selected, the information for the **IP Address**, **Subnet**, and **Gateway** fields must be entered.

IP Address

Displays the IP address used by the channel. This field can only be changed if **Static** mode is selected.

Subnet

Displays the subnet mask for the channel. This field can only be changed if **Static** mode is selected.

Gateway

Displays the gateway (router) address for the channel. This field can only be changed if **Static** mode is selected.

MAC Address

The MAC address of the Ethernet channel.

Pairing tab

The **Pairing** tab provides the ability to pair the OmniStream 311 with up to seven OmniStream 324 devices.

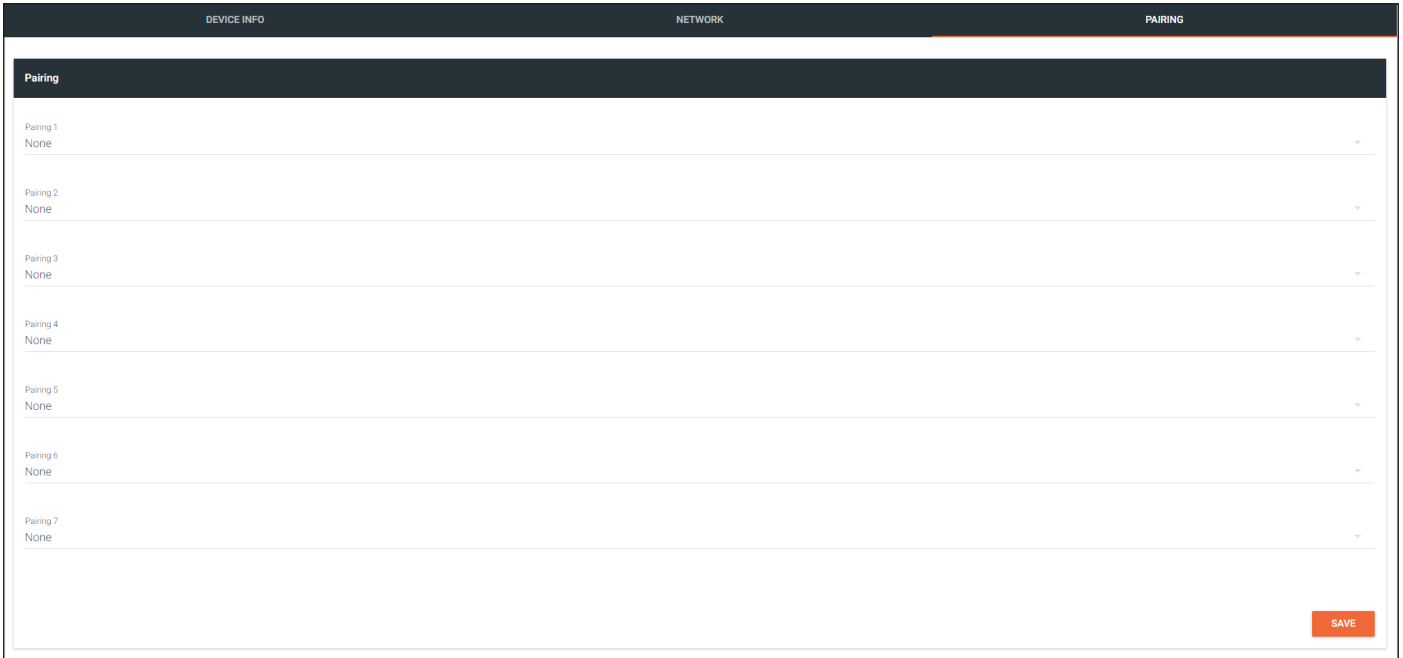

The screenshot shows the AMS interface with three tabs: DEVICE INFO, NETWORK, and PAIRING. The PAIRING tab is active and displays a table with seven rows, each labeled 'Pairing 1' through 'Pairing 7'. Each row has a dropdown menu currently set to 'None'. A 'SAVE' button is located in the bottom right corner of the interface.

Pairing	Device
Pairing 1	None
Pairing 2	None
Pairing 3	None
Pairing 4	None
Pairing 5	None
Pairing 6	None
Pairing 7	None

Pairing (1 - 7)

Click this drop-down list to pair the OmniStream 311 with the desired OmniStream 324. To unpair an OmniStream 311 and an OmniStream 324, select the **None** option.

Appendix

Specifications

USB	
Signal	2.0
Maximum Data Rate	480 Mbps

Distance	Feet	Meters
Per hop of Ethernet cable	330	100

Connectors, Controls, and Indicators	
USB	1 - Type B, 4-pin female
LAN	1 - RJ45, shielded
UTILITY	1 - 3.5 mm mini-stereo
PAIRING	1 - Push button, tact-type, recessed
PWR indicator	1 - LED, green
LINK indicator	1 - LED, green
HOST indicator	1 - LED, green
SIGNAL indicator	1 - LED, green

Temperature	Fahrenheit	Celsius
Operating	32 to 122	0 to 50
Storage	-20 to 70	-4 to 158

Humidity	
Operating (RH)	20% to 80% (non-condensing)
Storage (RH)	10% to 90% (non-condensing)

Power	
Supply	Powered by USB host device

Dimensions	Inches	Millimeters
H x W x D	1.04 x 3.92 x 3.01	26.40 x 99.50 x 76.45

Weight	Pounds	Kilograms
Device	0.50	0.23

Certifications	
Device	CE, FCC, CB, RoHS

