



Introduction

Video support.....	3
USB support.....	4
Audio support.....	4
Serial communication support.....	4
Tips for achieving good quality links.....	5
AdderLink XD522 unit features.....	6
Supplied items.....	7
Optional extras.....	8

Installation

Mounting.....	9
Connections.....	10
Transmitter.....	10
Video connections.....	10
USB connections.....	10
Audio connections.....	11
Serial connection.....	12
Link connections.....	12
Power connection.....	13
Receiver.....	14
Video display connections.....	14
USB connections.....	15
Audio connections.....	16
Serial connection.....	18
Link connections.....	18
Power connection.....	19

Configuration

Performing an upgrade.....	20
Choosing the audio input mode.....	20

Operation

Front panel indicators.....	21
Operating Modes.....	21
Using hotkeys.....	22
The Dashboard.....	22

Further information

Getting assistance.....	23
General specifications.....	23
Appendix A.....	24
Appendix B.....	25
Appendix C.....	26
Appendix D.....	27

Index

Introduction

AdderLink XD522 is a high performance DisplayPort KVM (Keyboard, Video, Mouse) extender that enables you to locate your critical computing hardware in a secure and temperature controlled environment away from the user work station whilst maintaining the same user desktop experience.

Using either one or two CATx cable links you can achieve separation distances of up to 150 meters/492 feet between the AdderLink XD522 transmitter and receiver units. At such distances the units can transfer high resolution DisplayPort video, USB 2.0 (low/full and Hi-Speed), digital and analog audio plus RS232 serial.

The units actively monitor the link quality and at link distances of less than 100 meters/328 feet, High Rate Mode* becomes possible; providing a second video port and more than twice the video bandwidth capability. In High Rate Mode, there is more than enough video bandwidth to support a single very high resolution 2560 x 1600 display or two 1920 x 1200 displays (@ 60Hz refresh) or even 4K video - 4096 x 2160 (@ 30Hz refresh, single display).

For AdderLink XD522 modules with firmware version 2.01 or later, the DisplayPort Audio and High Dynamic Range video capabilities are fully supported.

- For DisplayPort Audio, providing your host PC video circuitry and video display support the standard, up to eight channels of digital audio can be extended across the link.
- High Dynamic Range (HDR) supports a 10-bit color depth, allowing the primary video display to show a wider gamut of 1.06 billion colours rather than the usual 16 million (when using an 8 bit colour depth). *Note: The maximum video resolution is reduced slightly when HDR 10-bit color is used.*

* subject to link cable quality

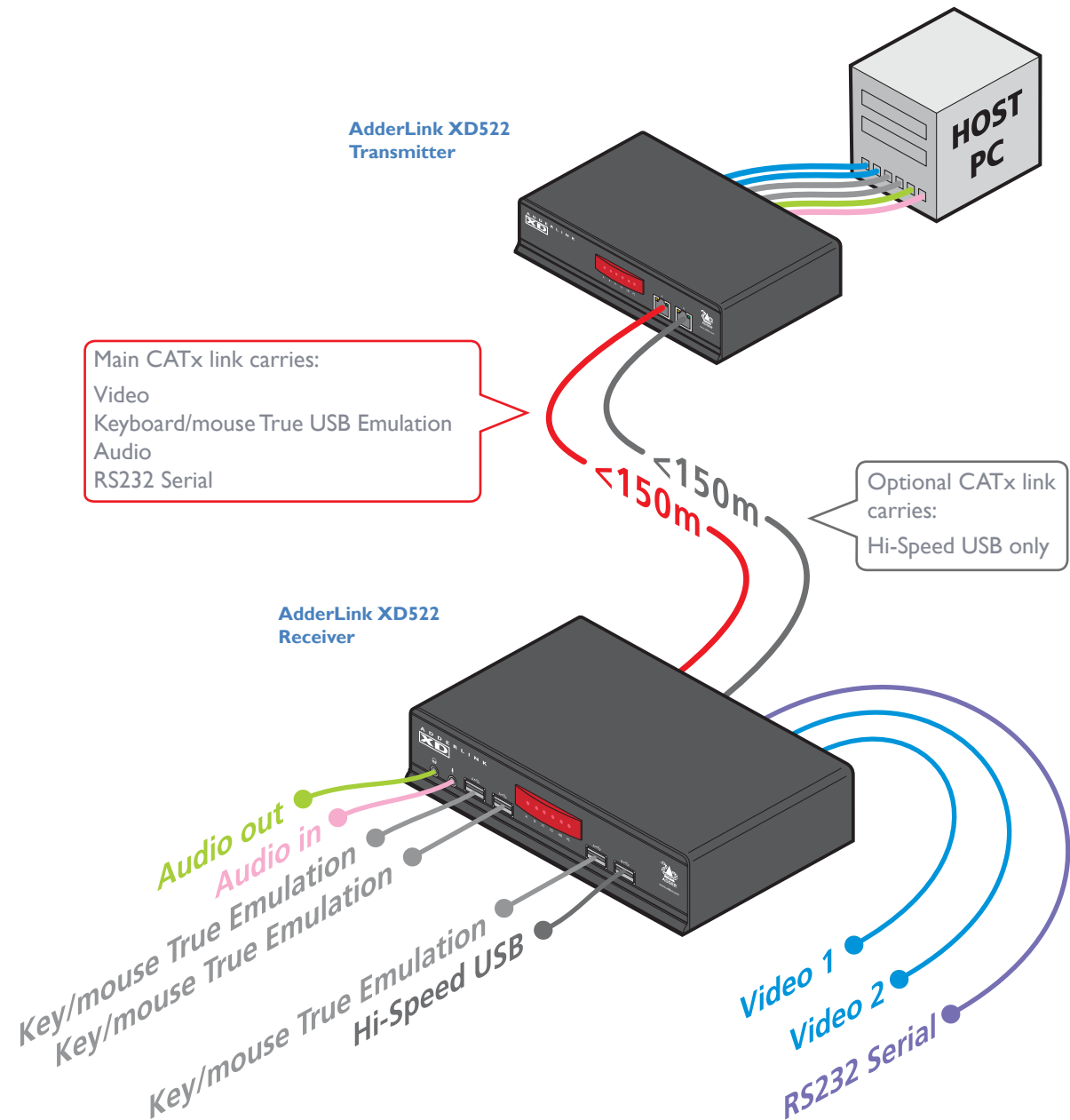

VIDEO SUPPORT

AdderLink XD522 works hard to transfer the highest possible video bandwidth between the transmitter and receiver units. To allow for the differing grades of CATx links used to join the transmitter and receiver, AdderLink XD522 periodically checks the quality of link A (the primary cable joining the transmitter and receiver). In this way it can accurately determine which of two video transfer modes can be supported. Please see [Tips for achieving good quality links](#) for further information. Please also see [Tested video resolutions](#).

On the front panel, the **HR** indicator will illuminate when High Rate mode is available, whereupon the second video port is enabled and the total available bandwidth for video signals is more than doubled.

The manner in which bandwidth is made available to the two video ports differs between the Low and High Rate modes, as described here:

Low rate mode

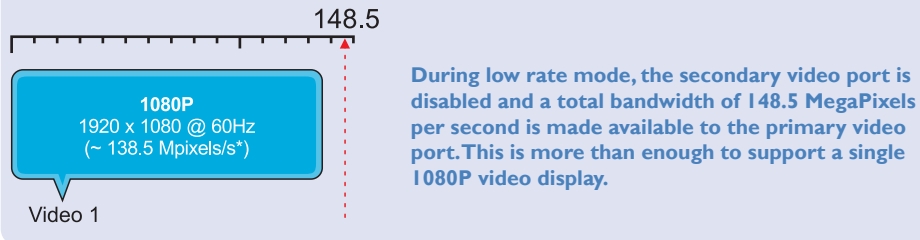

Notes:

- The AdderLink XD522 is not recommended for use with the NVIDIA Quadro FX 3800 graphics card. Please contact Adder technical support for more information.
- The example modes shown here are for illustrative purposes and are based upon average requirements for current video displays. Video displays from some manufacturers may consume more signal bandwidth than those shown here.

* All approximate video mode bandwidth figures are quoted with reduced blanking.

EDID management

AdderLink XD522 intelligently manages the EDID (Extended Display Identification Data) information that each video display provides (detailing their supported resolutions) before reporting them to the host PC. In this way AdderLink XD522 can mask the resolution modes that cannot be supported within the available bandwidth. The display attached to Video port 1 will always be given priority. If sufficient bandwidth does not exist for the modes declared by the second display, then it will not be reported to the host PC. Please see [Appendix B](#) for details about how the EDID details supplied by each display are managed.

High rate mode

This diagram indicates how the total bandwidth of the high rate mode can be shared between the two video ports.

Video port 1 (which has priority) may take up 280 MegaPixels per second (of the total 308 Mpix/sec bandwidth); while port 2 can use a maximum of 154 Mpix/sec (subject to port 1 using no more than 154 Mpix/sec of the available total bandwidth).

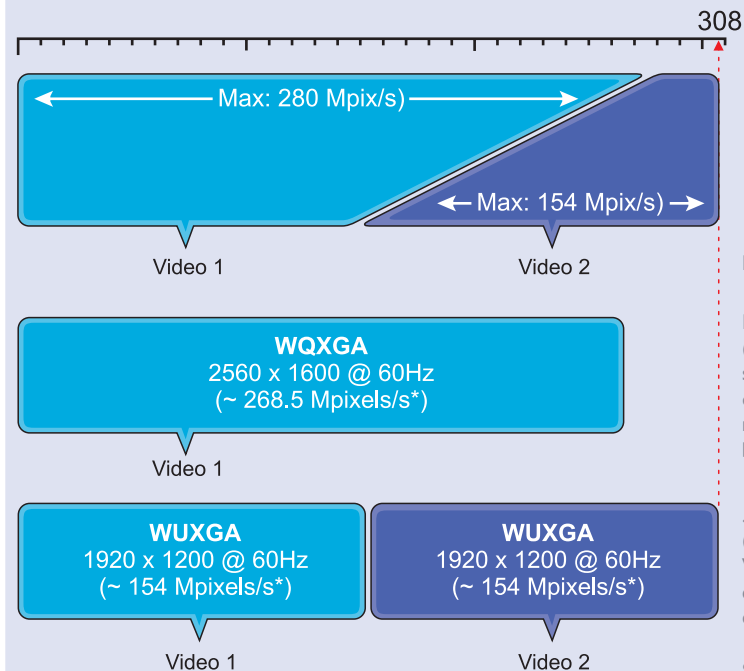

For example:

Priority mode
(Hotkey option 7) A single WQXGA mode display could consume nearly all of the port 1 bandwidth alone, or...

... **Balanced mode**
(Hotkey option 6) Two WUXGA mode displays could share the total evenly.

See "Using hotkeys" on page 22 for more details.

USB SUPPORT

AdderLink XD522 units provide support for a wide range of USB devices via four ports on the receiver unit. Three of the ports (labeled A) support low/full speed (v2.0) USB and are made possible using Adder's proprietary *True USB Emulation* technique which is specifically designed to overcome the problems usually encountered when remotely connecting USB keyboards and mice. The fourth port (labeled B) provides Hi-Speed (v2.0) USB with transfer rates up to 480Mbits/sec.

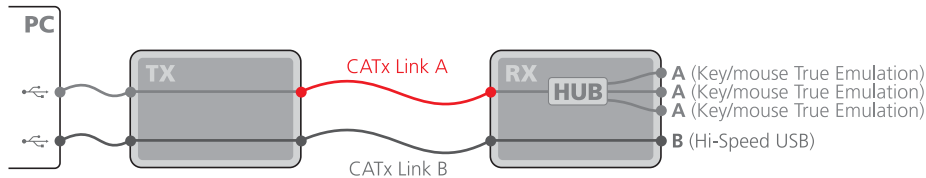

The three A ports support only USB keyboards and mice.

Port B provides Hi-Speed USB support for mass storage and isochronous devices.

Note: Availability of the fourth (B) USB port depends upon the use of CATx Link B which is used solely for the transport of Hi-Speed USB signals.

AUDIO SUPPORT

The AdderLink XD522 units can transfer analog and digital audio signals across the CATx cable link. Standard analog audio is supported through 3.5mm jacks on the transmitter and receiver units: Line In/Out on the transmitter; Line In/Out plus Microphone/Headphones on the receiver.

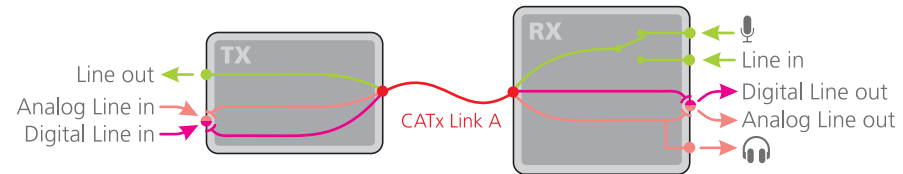

Additionally, the Line In socket on the transmitter and the Line Out socket on the receiver are dual purpose. They can accept either 3.5mm analog jacks or mini-TOSLINK optical fiber connectors. The latter provide access to the optical S/PDIF (Sony/Philips Digital InterFace) capabilities supported by the AdderLink XD522 system, which transmits PCM (Pulse Code Modulation) audio at 96KHz. The digital and analog channels run independently alongside each other via the CATx link.

Third party adaptors (not supplied) are available to convert between the mini-TOSLINK connections used on the AdderLink XD522 units and the more common full size TOSLINK connectors found on many audio/visual devices.

Note: DisplayPort audio is supported if the monitor and graphics card of the host PC support this. Up to 8 audio channels are supported via the DisplayPort connector.

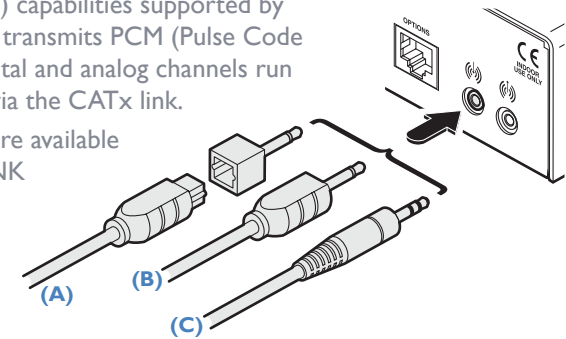

- (A) TOSLINK connector with mini-TOSLINK converter
- (B) Mini-TOSLINK connector
- (C) Standard analog 3.5mm stereo jack

SERIAL COMMUNICATION SUPPORT

The AdderLink XD522 transmitter and receiver both have serial Options ports which are used for firmware upgrades but are also available during normal use for transferring high speed serial data across the CATx link. This means that you can connect the serial port of the Host computer to the transmitter and any serial device to the receiver. These can then freely communicate at up to 115,200 baud across the transparent link. No serial configuration is required on the AdderLink XD522 units as they merely pass through the serial signals.

TIPS FOR ACHIEVING GOOD QUALITY LINKS

Due to the large volumes of data that must be transferred between the transmitter and receiver, every AdderLink XD522 installation is highly dependent upon good quality CATx cable links. Video performance is particularly reliant on high speed communication channels. For this reason, the AdderLink XD522 units periodically test the link quality to determine which of two video transfer modes can be supported: Low Rate or High Rate. Please see [Video support](#) for details about high and low rate video modes.

The main factors that affect link quality are:

- The length and type of CATx cable used,
- The number, length and type of intermediate patch connections,
- The quality of the cable terminations.

Essential cable properties

- A gauge (thickness) of 23AWG or better is recommended.
 - The cable screening should be: S/FTP, S/STP or PiMF.
- Please see [Appendix D - Link cable interference protection](#) for details.

As illustrated in the table below, the cable type has quite a marked effect on the maximum distance that can be achieved with High Rate mode:

Low rate mode



To achieve 150m (in LR mode), the cable thickness is important: Use 23AWG (or thicker).

High rate mode

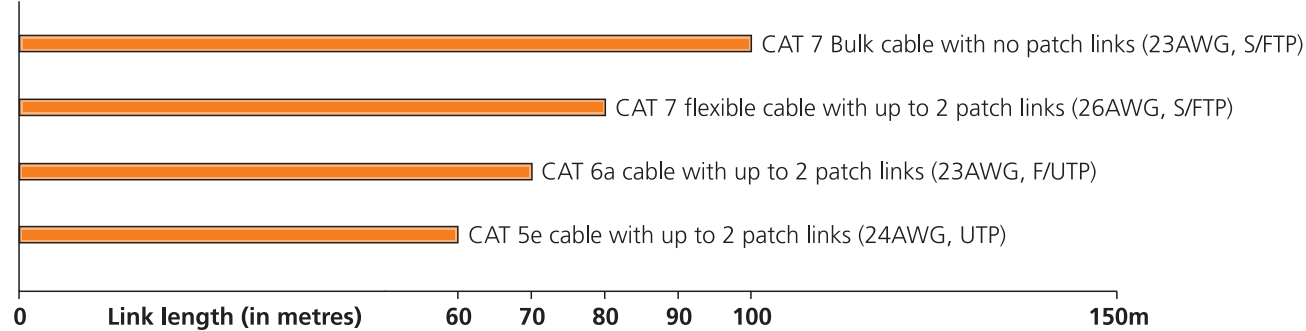

To achieve 100m (in HR mode), both the thickness *and* screening are important: Use 23AWG (or thicker) with S/FTP screening.

As mentioned above, patch links affect performance. For each additional break/patch within a run, you will need to reduce the distance given above by roughly 5 meters.

For best results, patch cables should be of type CAT 7a and be less than 2 meters in length. If patch cables are greater than 2 meters, then they must be CAT 7a.

Adder recommend the following CAT 7 shielded, foiled, twisted pair cables:

- Flexible patch cable Daetwyler 7702 (26AWG S/FTP)
- Bulk cable Daetwyler 7120 (23AWG S/FTP)

Please see [Appendix D - Link cable interference protection](#) for details about cable screening and shielding.

ADDERLINK XD522 UNIT FEATURES

The AdderLink XD522 units are housed within durable, metallic enclosures with port connectors situated on the front and rear panels. The smart front faces also feature the operation indicators.

Transmitter - front

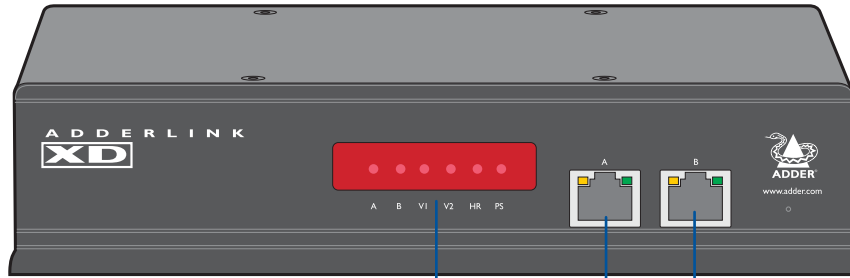

Main A link
Optional B link

Receiver - front

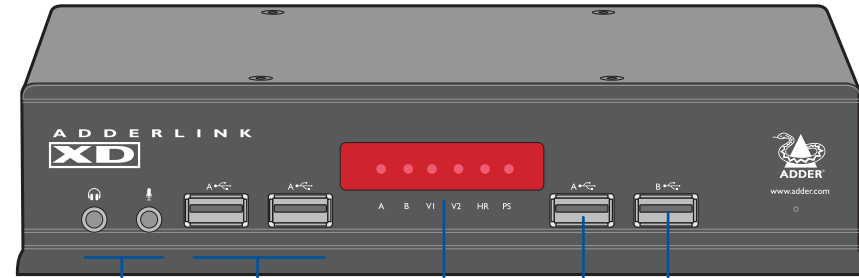

Headphone/microphone sockets
True Emulation USB ports
True Emulation USB port
Hi-Speed USB port

Indicators

These six indicators clearly show the key aspects of operation:

- | | |
|--|--|
| <ul style="list-style-type: none"> • A On Main A link is connected.
Flashes Main A link is not connected.
Off No power is present. • B On Optional B link is connected.
Off Optional B link is not connected. • VI On Video port 1 is connected and receiving video.
Flashes Video port 1 is connected but not receiving video.
Off Video port 1 is not connected. | <ul style="list-style-type: none"> • V2 On Video port 2 is connected and receiving video.
Flashes Video port 2 is connected but not receiving video.
Off Video port 2 is not connected. • HR On High Rate mode is active.
Flashes High Rate mode is preferred but cannot be established, LR mode active.
Off Low Rate mode is active. • PS On Power connected.
Flashes Upgrade error (other indicators show error code).
Off No power. |
|--|--|

Transmitter - rear

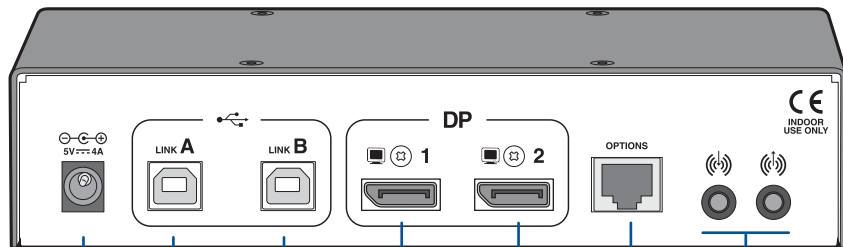

Power input
USB link A port
USB link B port
Primary DisplayPort video input
Secondary DisplayPort video input
Multi function Serial port
Audio line in/out
Line In jack supports mini-TOSLINK

Receiver - rear

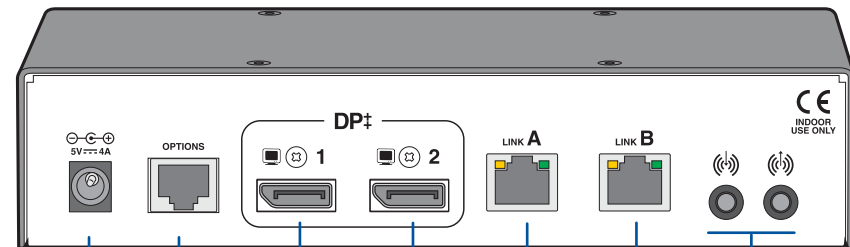

Power input
Multi function Serial port
Primary DisplayPort video output
Secondary DisplayPort video output
Main A link
Optional B link
Audio line in/out
Line Out jack supports mini-TOSLINK

SUPPLIED ITEMS

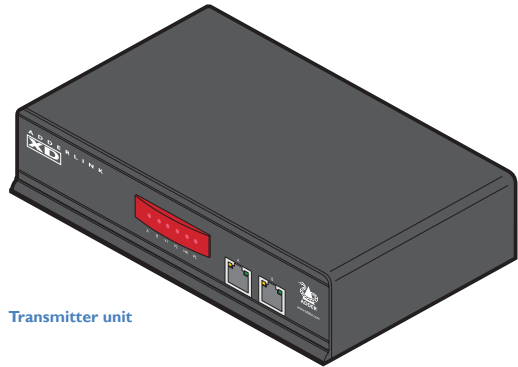

Transmitter unit

Power adaptor (20W) and country-specific power lead

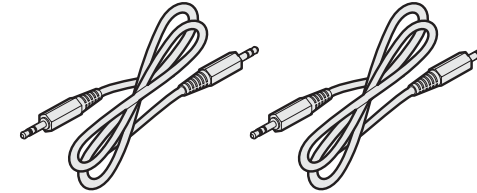
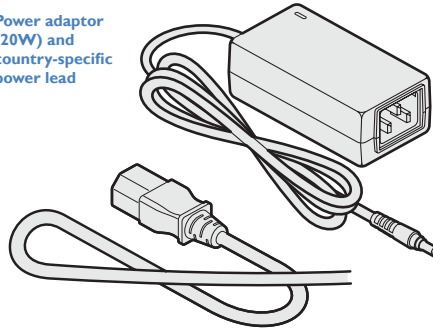

2 x Audio cable 2m (3.5mm stereo jacks)
Part number:VSC22

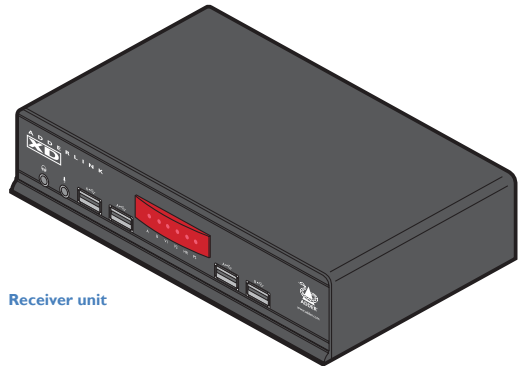

Receiver unit

Power adaptor (20W) and country-specific power lead

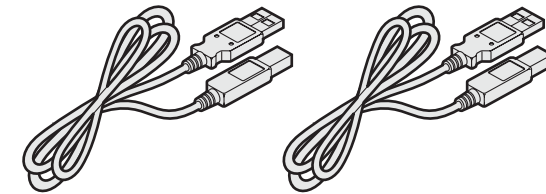
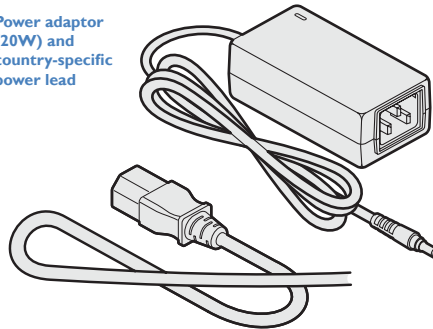

2 x USB cable 2m (type A to B)
Part number:VSC24

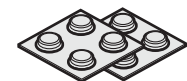

Eight self-adhesive rubber feet

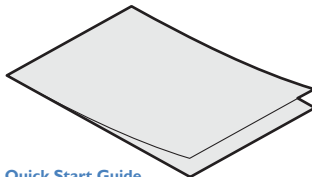

Quick Start Guide

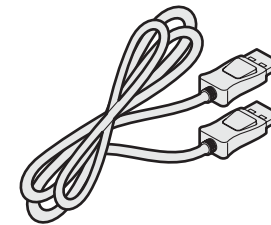

DisplayPort cable
Part number:VCS17

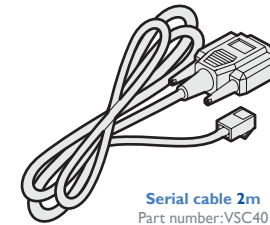

Serial cable 2m
Part number:VSC40

OPTIONAL EXTRAS

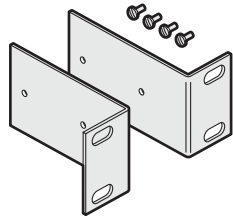

Two 19" rack-mount brackets and four screws

Part numbers:
One unit per 1U rack slot: RMK4S
Two units per 1U rack slot: RMK4D

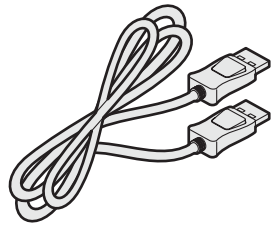

DisplayPort cable
Part number: VCS D17

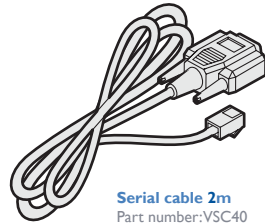

Serial cable 2m
Part number: VSC40

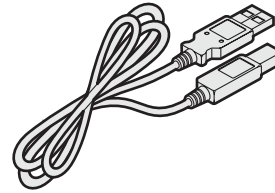

USB cable 2m (type A to B)
Part number: VSC24

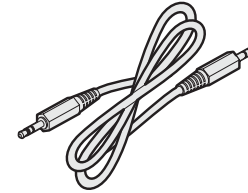

**Audio cable 2m
(3.5mm stereo jacks)**
Part number: VSC22

MOUNTING

There are two main mounting methods for transmitter and receiver units:

- The supplied self-adhesive rubber feet
- Optional rack brackets

[Connections](#)

Note: The units and their power supplies generate heat when in operation and will become warm to the touch. Do not enclose them or place them in locations where air cannot circulate to cool the equipment. Do not operate the equipment in ambient temperatures exceeding 40°C. Do not place the products in contact with equipment whose surface temperature exceeds 40°C.

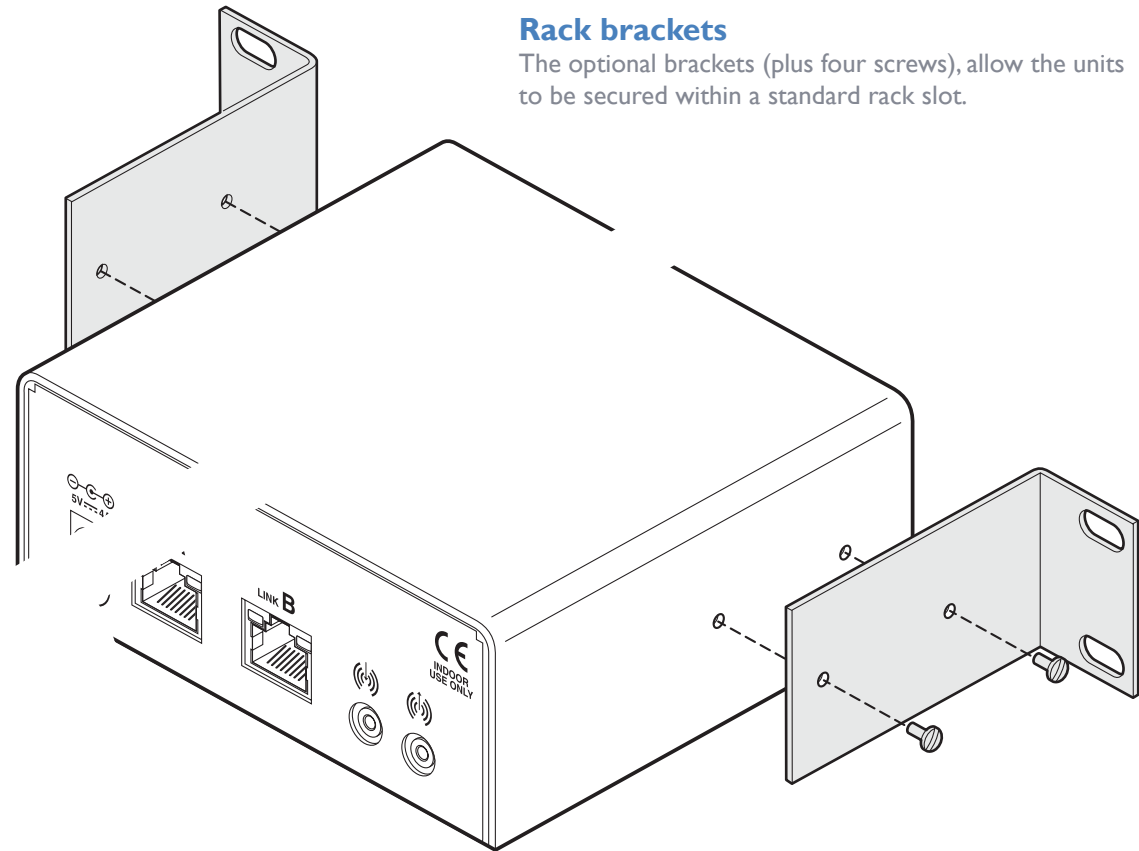

Rack brackets

The optional brackets (plus four screws), allow the units to be secured within a standard rack slot.

CONNECTIONS

Connections to the AdderLink XD522 units do not need to be carried out in the order given within this guide, however, where possible connect the *power in* as a final step.

Transmitter

Video connections

Video connections are made between the host computer and the two DisplayPort sockets on the rear panel of the transmitter unit.

To connect the video ports

- 1 Use the supplied DisplayPort video cable to link DP port 1 on the rear panel of the transmitter unit with the primary video output socket of the host computer.

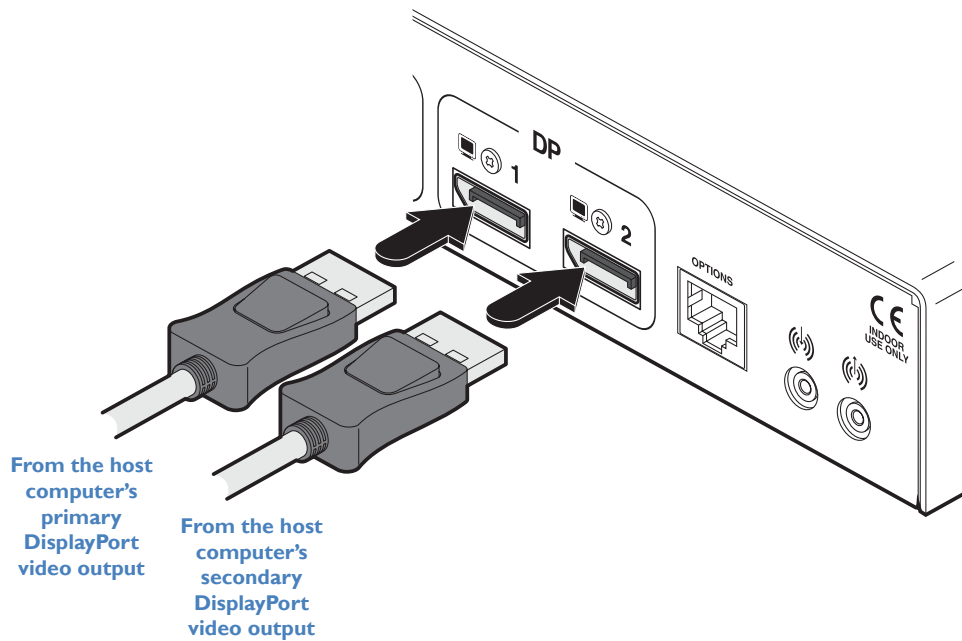

- 2 If a second video display is required, use an additional DisplayPort video cable (Adder part number:VSCD17) to link DP port 2 on the rear panel of the transmitter unit with the secondary video output socket of the host computer.

USB connections

USB connections are made between the host computer and the two sockets on the rear panel of the transmitter unit, labeled Link A and Link B.

Link A provides low/full speed USB to the three USB ports (all labeled A) that are located on the front panel of the AdderLink XD522 receiver. The optional Link B provides Hi-Speed USB to the single USB port (labeled B) that is also located on the front panel of the AdderLink XD522 receiver.

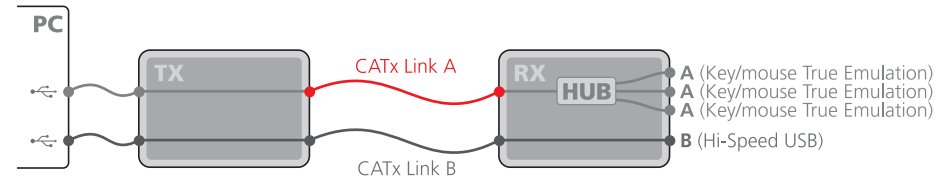

Note: Low/full speed USB devices can also be used on port B; the transfer speed will be automatically reduced. The A ports support USB keyboards and mice only.

To connect the USB ports

- 1 Use one of the supplied USB cables to connect the Link A socket on the rear panel of the transmitter unit with a vacant USB socket on the host computer.

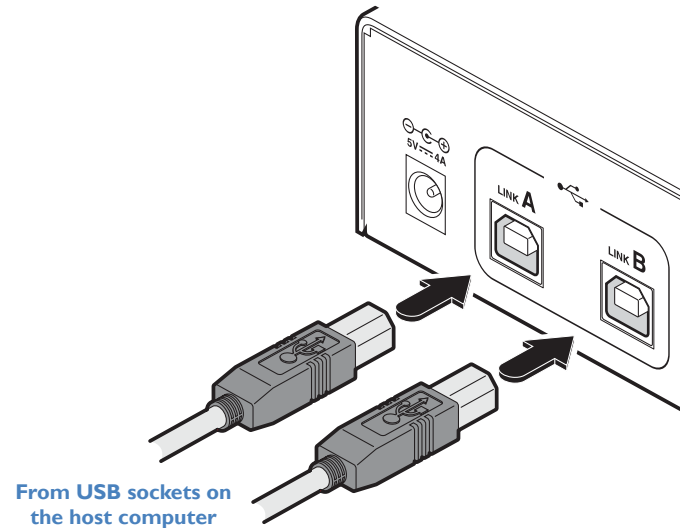

- 2 If the USB port B is required (on the receiver unit), use the second supplied USB cable to connect the Link B socket on the rear panel of the transmitter unit with a vacant USB socket (v2.0) on the host computer.

Audio connections

The AdderLink XD522 units support analog and digital audio. Line in and line out connectors are provided on both the transmitter and receiver units. Additionally, the receiver has dedicated headphone and microphone jacks on its front panel.

The Line In (🔊) socket on the transmitter and the Line Out (🔊) socket on the receiver are dual purpose. They can accept either 3.5mm analog jacks or mini-TOSLINK optical fiber connectors. The latter provide access to the optical S/PDIF (Sony/Philips Digital InterFace) capabilities supported by the AdderLink XD522 system, which transmits PCM (Pulse Code Modulation) audio at 96KHz. The digital and analog channels run independently alongside each other via the CATx link.

Third party adaptors (not supplied) are available to convert between the mini-TOSLINK connections used on the AdderLink XD522 units and the more common full size TOSLINK connectors found on many audio/visual devices.

To connect analog audio

- 1 Use the supplied 3.5mm jack audio cable to connect the Line In (🔊) socket on the transmitter to the analog Line Out or speaker socket of the host computer.

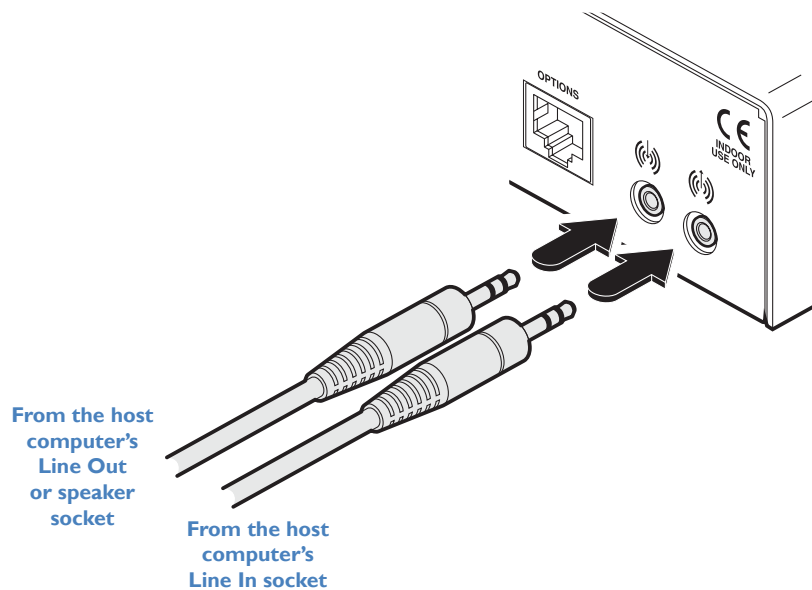

- 2 If a microphone or other audio input is required (from the AdderLink XD522 receiver back to the host computer), use another 3.5mm jack audio cable to connect the Line Out (🔊) socket on the transmitter to the analog Line In socket of the host computer

To connect digital audio

- 1 Use either a mini-TOSLINK fiber optic cable (or a full size TOSLINK fiber optic cable plus a mini-TOSLINK adaptor) to connect the Line In (🔊) socket on the transmitter to the digital Line Out socket of the host computer.

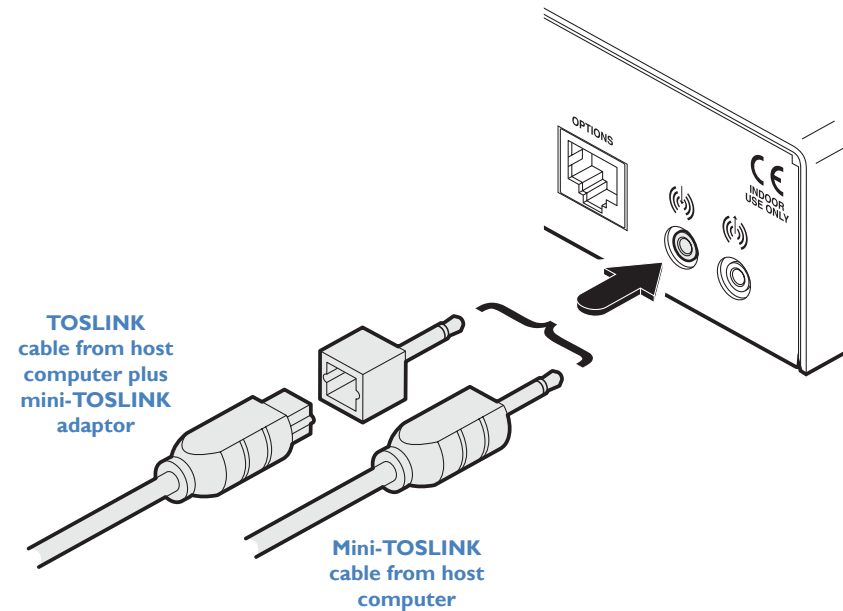

Note: This digital input is fed across the main CATx link to the optical connection of the receiver's Line Out socket only. There is no crossover between the analog and digital audio subsystems of the AdderLink XD522 installation.

Serial connection

The Options port on the rear panel of every AdderLink XD522 unit operates as a serial connection that can either:

- Be used to update the firmware of the unit (see [Performing an upgrade](#) for details), or
- Provide an RS232 serial connection that is passed between the transmitter and receiver.

Whenever the AdderLink XD522 units are not in upgrade mode, they are ready to transfer serial data between them at rates up to 115200 baud. When serial devices are attached to the Options ports on the transmitter and receiver, the units transparently convey the signals between them - no serial configuration is required.

To connect serial devices

- 1 Use the supplied serial cable to link the Options port on the rear panel of the transmitter unit with a vacant RS232 serial port on the host computer.

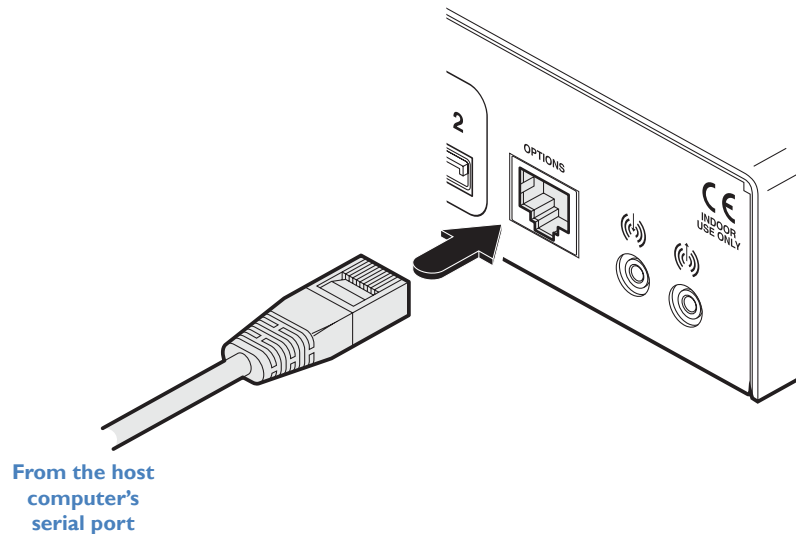

Please see [Appendix A](#) for pin-out details of the Options port.

Link connections

AdderLink XD522 transmitter and receiver units are linked by either one or two CATx cables at a distance of up to 150 meters (492 feet). The type and quality of the CATx cables used are crucial to the mode of operation (please see the section [Tips for achieving good quality links](#)). If Hi-Speed USB is not needed at the receiver then a CATx link between the B ports of the units is not necessary.

IMPORTANT: The signals sent through the link cables are NOT compatible with standard networking equipment and could cause damage if connected. Do not connect the transmitter or receiver modules to any other networking devices.

To link the units

- 1 Connect the CATx link cable from port A of the receiver unit to port A on the front panel of the transmitter unit.

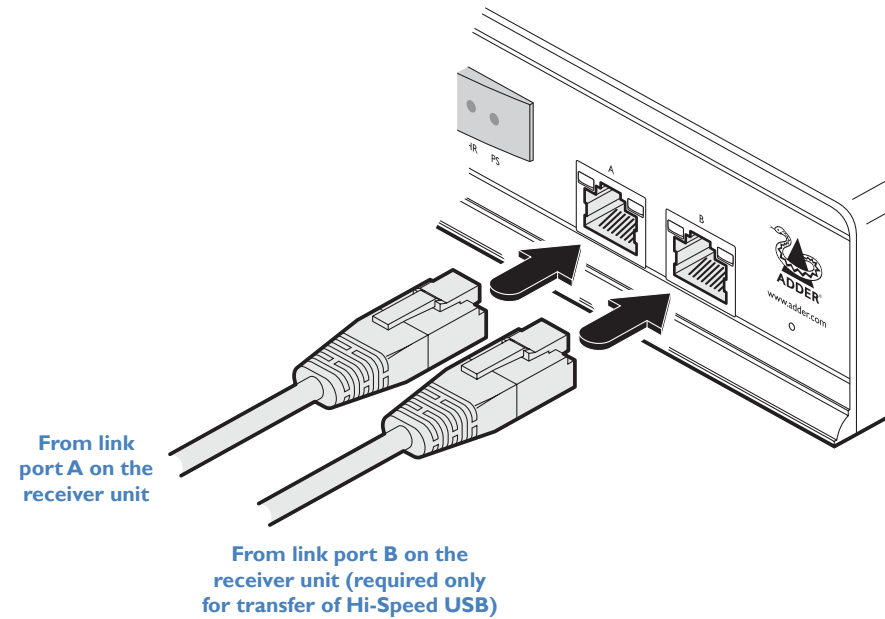

- 2 If Hi-Speed USB is required, connect the CATx link cable from port B of the receiver unit to port B on the front panel of the transmitter unit.

Power connection

Each AdderLink XD522 unit is supplied with a 20W power adaptor. There is no on/off switch on the unit, so operation begins as soon as a power adaptor is connected.

To connect the power supply

- 1 Attach the output lead from the power adaptor to the 5V socket on the rear panel of the unit.

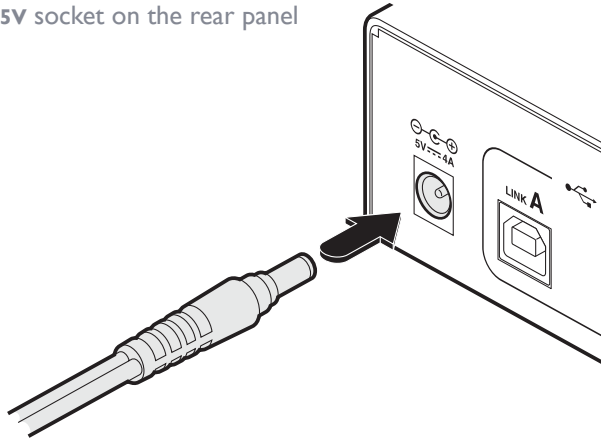

Note: Both the unit and its power supply generate heat when in operation and will become warm to the touch. Do not enclose them or place them in locations where air cannot circulate to cool the equipment. Do not operate the equipment in ambient temperatures exceeding 40 degrees Centigrade. Do not place the products in contact with equipment whose surface temperature exceeds 40 degrees Centigrade.

- 2 Connect the IEC connector of the supplied country-specific power lead to the socket of the power adaptor.

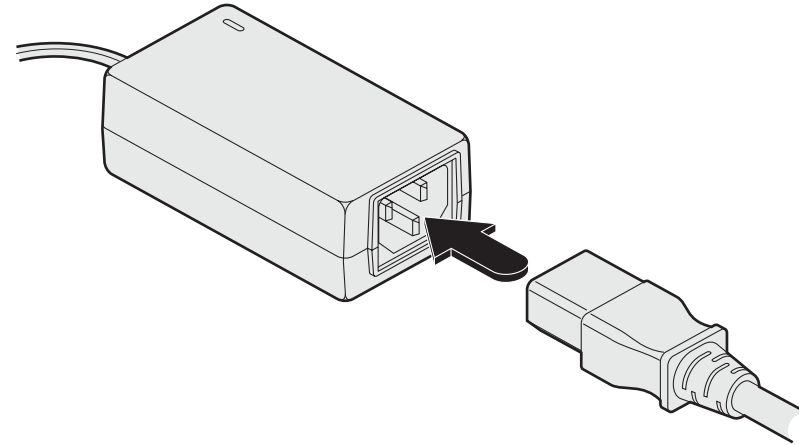

- 3 Connect the power lead to a nearby mains supply socket.

Receiver

Video display connections

Two DisplayPort sockets are provided on the rear panel of the receiver unit. When using high resolution video displays, it is important that their video bandwidth requirements lie within the capabilities of the DisplayPort socket to which they are attached. The bandwidth available at the two sockets on the receiver unit can be different and are greatly affected by the mode in which the AdderLink XD522 system is running. Please see [Video support](#) for details about high and low rate video modes and supported resolutions.

The link capacity (between transmitter and receiver) is checked periodically to determine which rate mode can be supported. Checks are generally made: When the units are powered up; when the main CATx link is made; if cables are disconnected or if the CATx link is lost for some other reason such as electrical interference. You can choose which rate mode is preferred (see [Using hotkeys](#)).

Support for other video standards

Both sockets support the DP++ (aka: DisplayPort Dual-Mode) standard, which means that as well as providing high resolution DisplayPort signals they can also sense when a single-link HDMI or DVI adaptor is attached. When this occurs, the output signals are adjusted accordingly to support those display types. Additionally, a (more complex) dual-link DVI adaptor can be attached (to port 1 only), which provides higher resolution signals for special DVI displays. Some adaptors use power from the video socket whereas others require an external power supply and this is usually gained from a spare USB socket. Port 1 can provide a higher bandwidth than port 2 (which is limited to a maximum of 154Mpixels/per second). Single-link DVI can require up to 165Mpixels/per second.

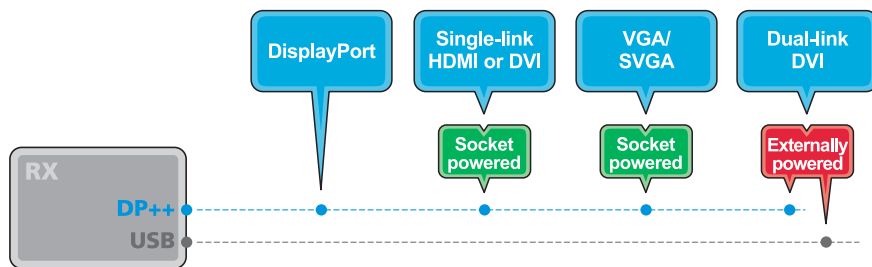

EDID management

AdderLink XD522 [intelligently manages](#) the EDID (Extended Display Identification Data) information that each video display provides (detailing their supported resolutions) before reporting them to the host PC. In this way AdderLink XD522 can mask the resolution modes that cannot be supported within the available bandwidth. The display attached to Video port 1 will always be given priority. If sufficient bandwidth does not exist for the modes declared by the second display, then it will not be reported to the host PC. EDID information is checked whenever a new monitor connection is sensed whereupon it is passed to the PC.

To connect the video ports

- 1 Connect the DisplayPort video cable from the primary video display to the DP++ port 1 on the rear panel of the receiver unit.

If an adaptor is being used to convert signals, connect it to the DP++ port 1 and connect the cable from the video display to the output of the adaptor. If an externally powered adaptor is required, you may need to also connect it to one of the USB ports in order to derive its power.

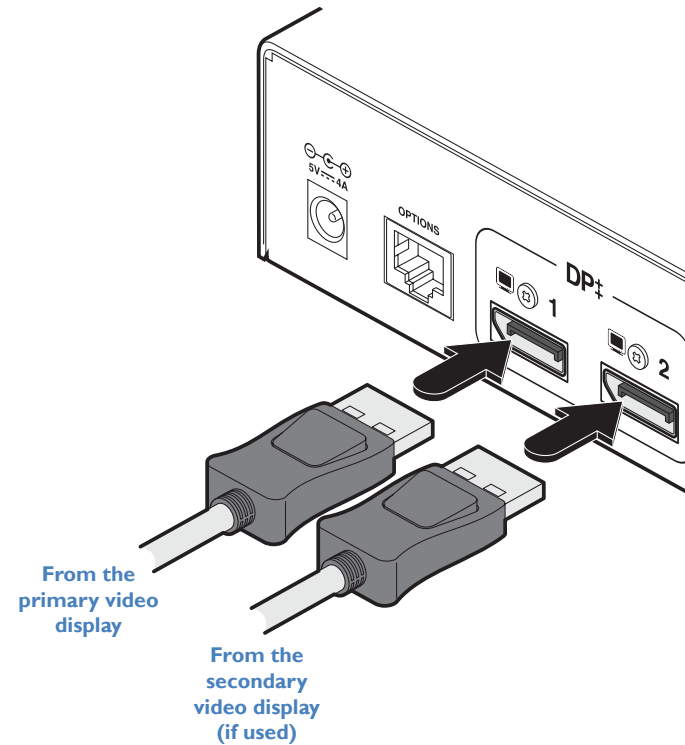

- 2 If a second video display is to be used, connect its cable to the DP++ port 2 on the rear panel of the receiver unit. If an adaptor is required, see above.

Note: Although port 2 supports DP++ dual-mode operation, it is limited to 154Mpixels/sec (when the AdderLink XD522 units are running in high rate mode). Some single-link video connections require up to 165Mpixels/sec.

USB connections

The AdderLink XD522 receiver provides four USB sockets on its front face:

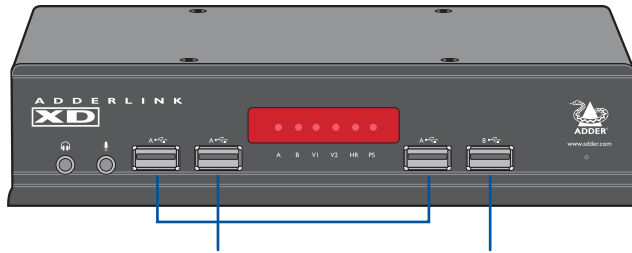

These three sockets are all labeled **A** and provide True Emulation ports for low/full speed USB keyboards and mice only. These are also suitable for providing power to 3rd party DisplayPort adaptors.

The fourth socket is labeled **B** and delivers Hi-Speed USB providing that:

- One of the host computer's USB sockets is connected to the Link B socket on the AdderLink XD522 transmitter and supports USB v2.0, and
- The second CATx link (B) is in place.

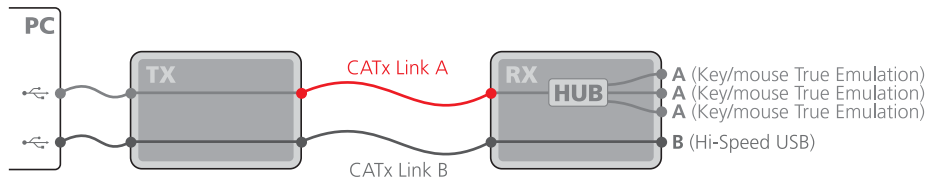

Note: Low/full speed USB devices can be used on port B; the transfer speed will be automatically reduced to support them.

To connect the USB ports

- 1 Connect the cable from your USB device to one of the vacant USB sockets on the receiver front panel.

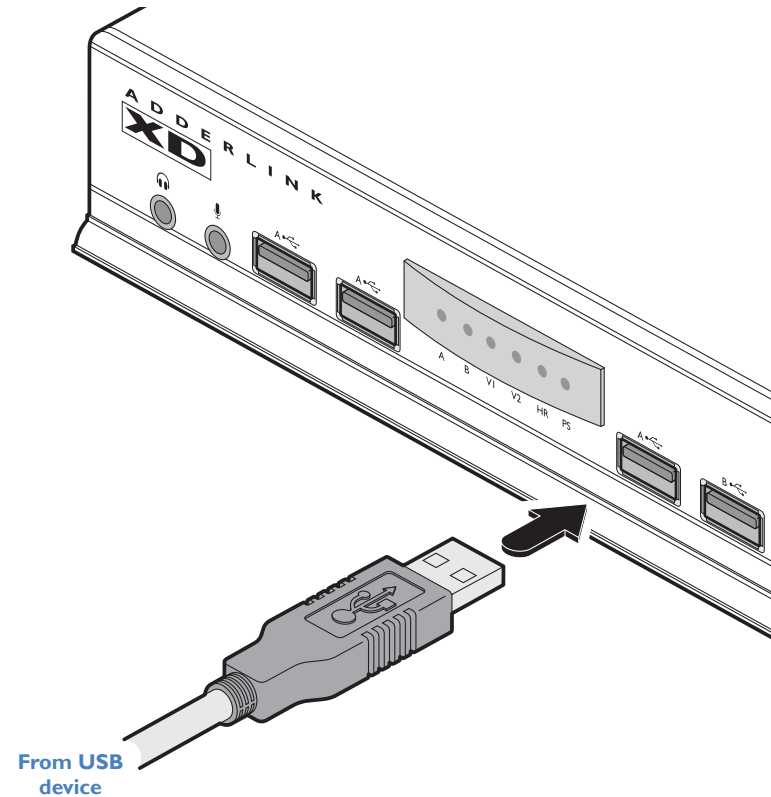

For Hi-Speed USB peripherals, such as mass storage devices, use socket **B**.

Audio connections

The AdderLink XD522 units support analog and digital audio. Line in and line out connectors are provided on both the transmitter and receiver units. Additionally, the receiver has dedicated headphone and microphone jacks on its front panel.

On the receiver, the analog portion of the Line Out (🔊) socket on the rear panel and the headphone socket on the front panel are joined and both provide the same output (but have different electrical properties). For the Microphone socket on the front panel and the Line In (🔊) socket on the rear, you can choose between the two inputs using a hotkey switch (see below for details).

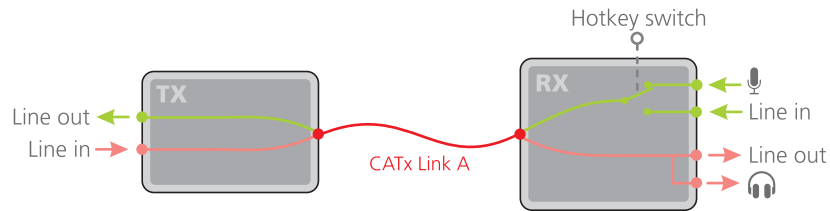

To connect headphones and/or a microphone

- 1 Connect the 3.5mm jack from your headphones to the 🎧 socket on the front panel of the receiver unit.

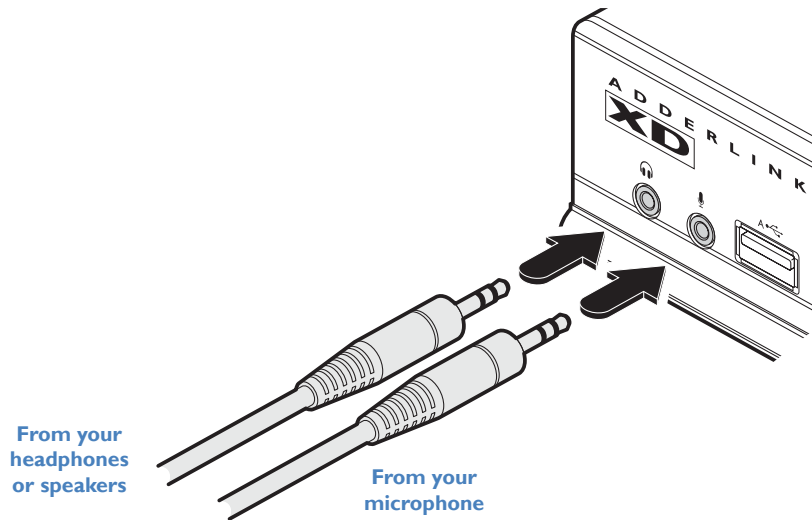

- 2 If a microphone is required, connect the 3.5mm jack from your microphone to the 🎤 socket on the front panel of the receiver unit.
- 3 Ensure that the microphone input is selected using the hotkey switch: Once the AdderLink XD522 receiver is powered on, use a USB keyboard attached to one of the A ports and press the **Ctrl** key **three times** in succession. Then press the **3** key (not from the numeric keypad), to select *Microphone* mode. The 🎤 icon will be displayed on screen to confirm your selection.

To connect speakers/line in/analog line out

- 1 Connect the 3.5mm jack from your powered speakers or the Line In socket of your audio device to the Line Out (🔊) socket on the rear panel of the receiver unit.

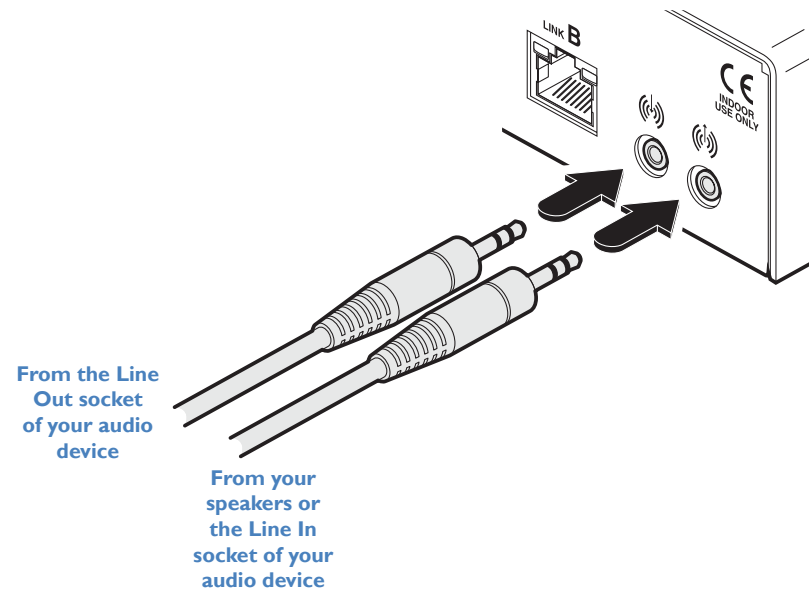

- 2 Connect the 3.5mm jack from the Line Out socket of your audio device to the Line In (🔊) socket on the rear panel of the receiver unit.
- 3 Ensure that the Line In input is selected using the hotkey switch: Once the AdderLink XD522 receiver is powered on, use a USB keyboard attached to one of the A ports and press the **Ctrl** key **three times** in succession. Then press the **2** key (not from the numeric keypad), to select *Line In* mode. The 🔊 icon will be displayed on screen to confirm your selection.

continued

Digital audio support

The Line In (🔊) socket on the transmitter and the Line Out (🔊) socket on the receiver are dual purpose. They can accept either 3.5mm analog jacks or mini-TOSLINK optical fiber connectors. The latter provide access to the optical S/PDIF (Sony/Philips Digital InterFace) capabilities supported by the AdderLink XD522 system, which transmits PCM (Pulse Code Modulation) audio at 96KHz. The digital and analog channels run independently alongside each other via the CATx link.

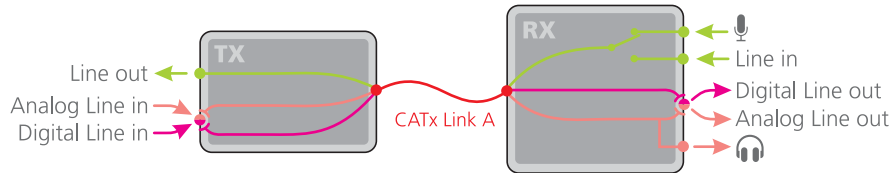

Third party adaptors (not supplied) are available to convert between the mini-TOSLINK connections used on the AdderLink XD522 units and the more common full size TOSLINK connectors found on many audio/visual devices.

To connect digital audio

- Use either a mini-TOSLINK fiber optic cable (or a full size TOSLINK fiber optic cable plus a mini-TOSLINK adaptor) to connect the Line Out (🔊) socket on the receiver to the digital Line In socket of the digital audio device.

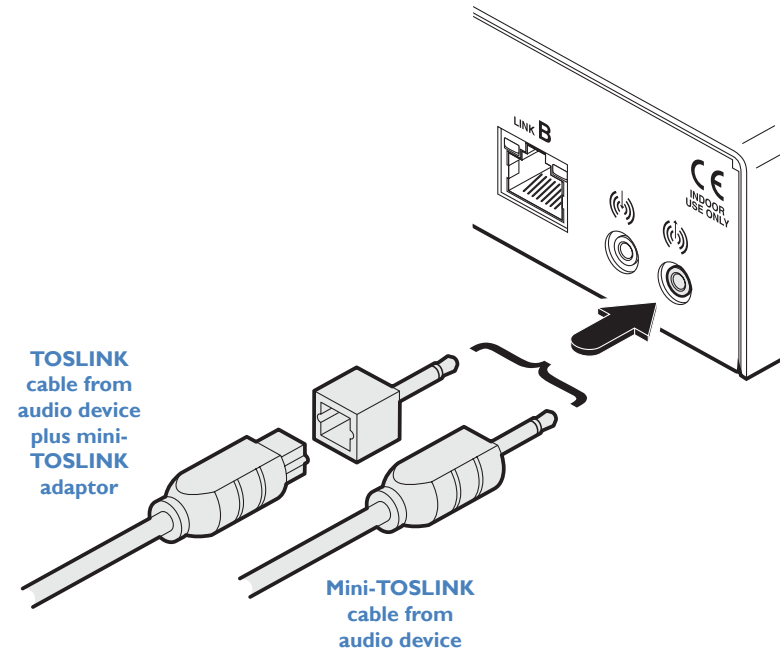

Note: This digital output is fed via the main CATx link from the optical connection of the transmitter's Line In socket only. There is no crossover between the analog and digital audio subsystems of the AdderLink XD522 installation.

Serial connection

The Options port on the rear panel of every AdderLink XD522 unit operates as a serial connection that can either:

- Be used to update the firmware of the unit (see [Performing an upgrade](#) for details), or
- Provide an RS232 serial connection that is passed between the transmitter and receiver.

Whenever the AdderLink XD522 units are not in upgrade mode, they are ready to transfer serial data between them at rates up to 115200 baud. When serial devices are attached to the Options ports on the transmitter and receiver, the units transparently convey the signals between them - no serial configuration is required.

To connect serial devices

- 1 Use a serial cable to link the Options port on the rear panel of the receiver unit with the serial device.

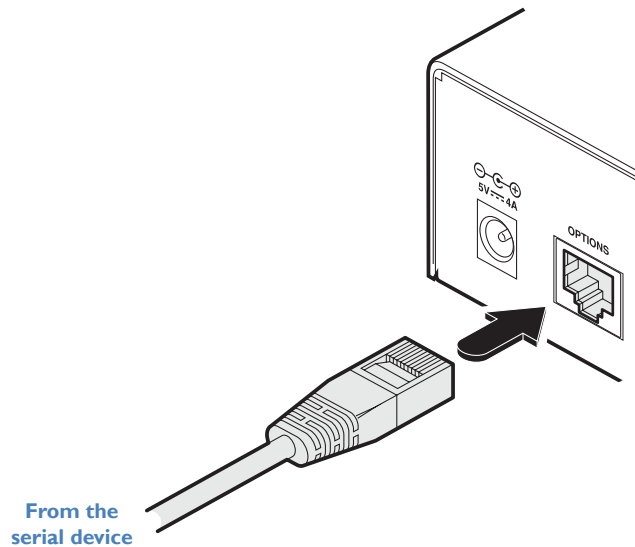

Link connections

AdderLink XD522 transmitter and receiver units are linked by either one or two CATx cables at a distance of up to 150 meters (492 feet). The type and quality of the CATx cables used are crucial to the mode of operation (please see the section [Tips for achieving good quality links](#)). If Hi-Speed USB is not needed at the receiver then a CATx link between the B ports of the units is not required.

IMPORTANT: The signals sent through the link cables are **NOT** compatible with standard networking equipment and could cause damage if connected. Do not connect the transmitter or receiver modules to any other networking devices.

To link the units

- 1 Connect the CATx link cable from port A (on the front panel) of the transmitter unit to the LINK A port on the rear panel of the receiver unit.

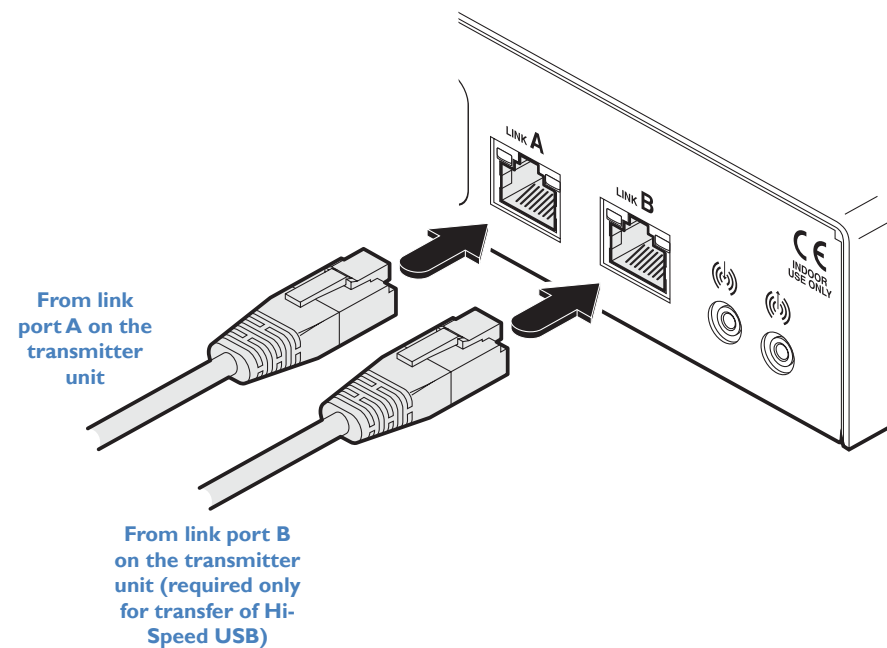

- 2 If Hi-Speed USB is required, connect the CATx link cable from port B (on the front panel) of the transmitter unit to the LINK B port on the rear panel of the receiver unit.

Power connection

Each AdderLink XD522 unit is supplied with a 20W power adaptor. There is no on/off switch on the unit, so operation begins as soon as a power adaptor is connected.

To connect the power supply

- 1 Attach the output lead from the power adaptor to the 5V socket on the rear panel of the unit.

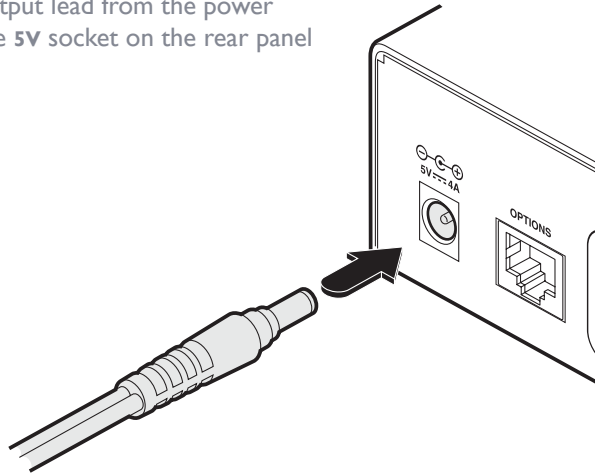

Note: Both the unit and its power supply generate heat when in operation and will become warm to the touch. Do not enclose them or place them in locations where air cannot circulate to cool the equipment. Do not operate the equipment in ambient temperatures exceeding 40 degrees Centigrade. Do not place the products in contact with equipment whose surface temperature exceeds 40 degrees Centigrade.

- 2 Connect the IEC connector of the supplied country-specific power lead to the socket of the power adaptor.

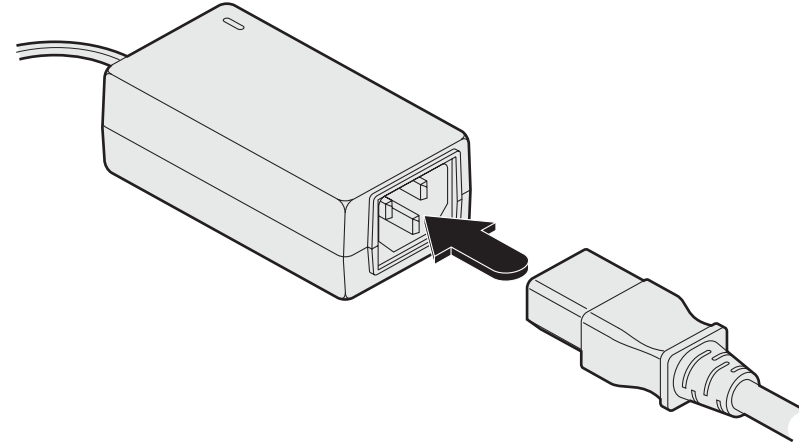

- 3 Connect the power lead to a nearby mains supply socket.

Configuration

PERFORMING AN UPGRADE

AdderLink XD522 units are flash upgradeable using the method outlined here. The same upgrade file is used to upgrade both the transmitter and receiver units (although they are upgraded individually).

Warning: During the upgrade process, ensure that power is not interrupted as this may leave the unit in an inoperable state.

- 1 Download the upgrade file from Adder's website.
- 2 Connect the supplied serial cable (VSC40) between your computer and the Options port of the AdderLink XD522 unit to be upgraded.
- 3 Use a narrow implement (e.g. a straightened-out paper clip) to press-and-hold the recessed reset button on the front panel until the indicators begin pulsing.

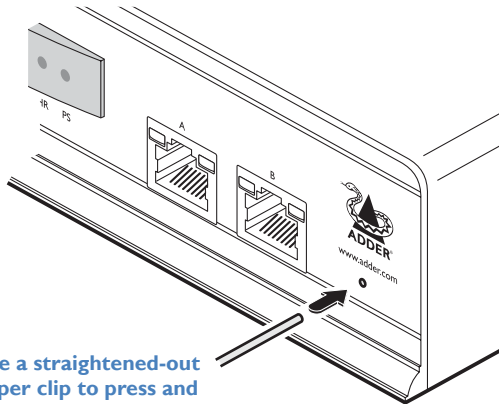

Use a straightened-out paper clip to press and hold the reset button until the front panel indicators respond

- 4 With the unit in download mode, transfer the upgrade file using an XMODEM file transfer via any terminal emulator program. Use the following settings: 115200 baud, 8 bit word, no parity, 1 stop bit (8N1) and no flow control.
- 5 Upon completion of the download, the unit will begin to upgrade its stored firmware. Once this process has completed the unit will reboot itself and begin to operate with the new firmware.

Finding the latest upgrade files

Firmware files for the units are available from the *Support > Firmware Updates* section of the Adder Technology website (www.adder.com).

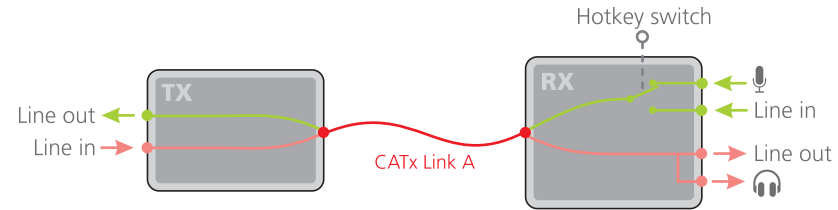

CHOOSING THE AUDIO INPUT MODE

The AdderLink XD522 receiver has two analog audio inputs: A microphone socket on the front panel and a Line In socket on the rear.



You can choose between these two analog inputs using a hotkey switch, as follows:

To choose between the Line In and Microphone inputs

- 1 Using a USB keyboard attached to one of the USB A ports on the AdderLink XD522 receiver, press the **Ctrl** key **three times** in succession. In response, the three keyboard indicators will all flash, once per second.
- 2 Use the numeric keys located above the main section of the keyboard (not the numeric keypad), to choose the required action:
 - 2 to select *Line In* mode. The  icon will be displayed on screen to confirm your selection.
 - 3 to select *Microphone* mode. The  icon will be displayed on screen to confirm your selection.

The chosen socket will be patched through (via the link cable) to the Line Out socket of the transmitter.

In operation, many AdderLink XD522 installations generally require no intervention once configured. The transmitter and receiver units take care of all connection control behind the scenes so that you can continue to work unhindered.

FRONT PANEL INDICATORS

The six front panel indicators on each unit provide a useful guide to operation:

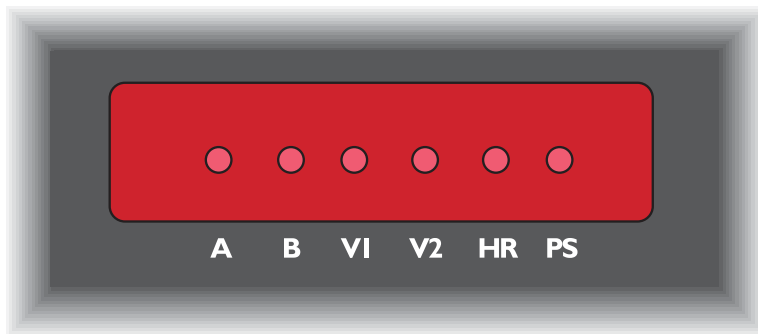

Indicators

These six indicators clearly show the key aspects of operation:

- **A** On Main A link is connected.
Flashes Main A link is not connected.
Off No power is present.
- **B** On Optional B link is connected.
Off Optional B link is not connected.
- **VI** On Video port 1 is connected and receiving video.
Flashes Video port 1 is connected but not receiving video.
Off Video port 1 is not connected.
- **V2** On Video port 2 is connected and receiving video.
Flashes Video port 2 is connected but not receiving video.
Off Video port 2 is not connected.
- **HR** On High Rate mode is active.
Flashes High Rate mode is preferred but cannot be established, LR mode active.
Off Low Rate mode is active.
- **PS** On Power connected.
Flashes Upgrade error (other indicators show error code).
Off No power.

OPERATING MODES

AdderLink XD522 units try at all times to maximize the data that can be transferred between them. The achievable throughput depends upon the length and quality of the cable links that join the units. Please see [Tips for achieving good quality links](#).

Video signals are most sensitive to link quality and for this reason the AdderLink XD522 units have two modes of operation: Low Rate and High Rate. The units periodically check the link quality and determine which video transfer mode can be successfully used. The difference between the two modes is considerable as High Rate mode can deliver over twice the video bandwidth. Please see [Video support](#) for details.

You can also choose which link rate mode you would prefer to use (subject to link cable suitability) by using the [Hotkey](#) functions - please see next page for details.









On-screen icons are displayed on the video display whenever the link mode changes, while the HR indicators on the front panels of both units continually show which mode is currently being used. If a rate change does occur, the entire data link will be reset. This will cause a momentary loss of the video, audio and USB services.

USING HOTKEYS

The AdderLink XD522 units provide hotkey features to allow you to check and adjust certain aspects of operation. Using the hotkeys you can:

- Monitor link quality using the Dashboard (see opposite),
- Choose the preferred link rate mode, and/or
- Choose between line in and microphone modes at the receiver.

To use hotkeys

- Using a USB keyboard attached to one of the USB A ports on the AdderLink XD522 receiver, press (and release) the **Ctrl (Ctrl)** key **three times** in succession (either of the keyboard's Ctrl keys can be used). In response, the three keyboard indicators will all flash, once per second. 
- Use the numeric keys 1 to 8 located above the main section of the keyboard (not the numeric keypad), to choose the required action:
 - Display the Dashboard. See opposite for details.
 - Select *Line In* mode for the receiver's analog audio input. The  icon will be displayed on screen to confirm your selection.
 - Select *Microphone* mode for the receiver's analog audio input. The  icon will be displayed on screen to confirm your selection.
 - Select *Low Rate (LR)* mode as the preferred link speed. The  icon will be displayed on screen to confirm your selection*.
 - Select *High Rate (HR)* mode as the preferred link speed. The  icon will be displayed on screen to confirm your selection*.
 - Select *Balanced* mode (available in HR mode only). The  icon will be displayed. Allows you to share the available video bandwidth equally between two video displays, regardless of the EDIDs being reported by them, e.g. 1920x1200 each on video displays that would ordinarily request a native mode of 2560x1600.
 - Select *Priority* mode (default mode). The  icon will be displayed. Video link 1 will take priority, allowing it to display resolutions greater than 1920x1200 (the limit for video link 2). [Appendix B](#) shows the logic process that is applied to the reported EDID in order to choose the most appropriate resolution.
 - Select *High Dynamic Range (HDR10)* (available in HR mode only). The icon  will be displayed. If your graphics card and monitor support 10 bit colour depth, this will now be sent over the extension link allowing up to 1.06 billion colours to be supported. In this mode the maximum supported video resolution is reduced as there is now more information per pixel (also, the secondary display will be disabled). It is not possible to support 4K video (3840x2160@30Hz) in this mode. The bit rate remains the same at 280Mb/sec.

Note: If you do not press any key within five seconds, or press any key other than the digits 1 to 8 (or once you have successfully chosen an action), the keyboard will revert to normal operation. To use another hotkey function, repeat the whole procedure described above.

The Dashboard

The Dashboard provides a quick overview of link quality as well as confirmation of the current link rate mode and the firmware revisions of both the transmitter and receiver units.



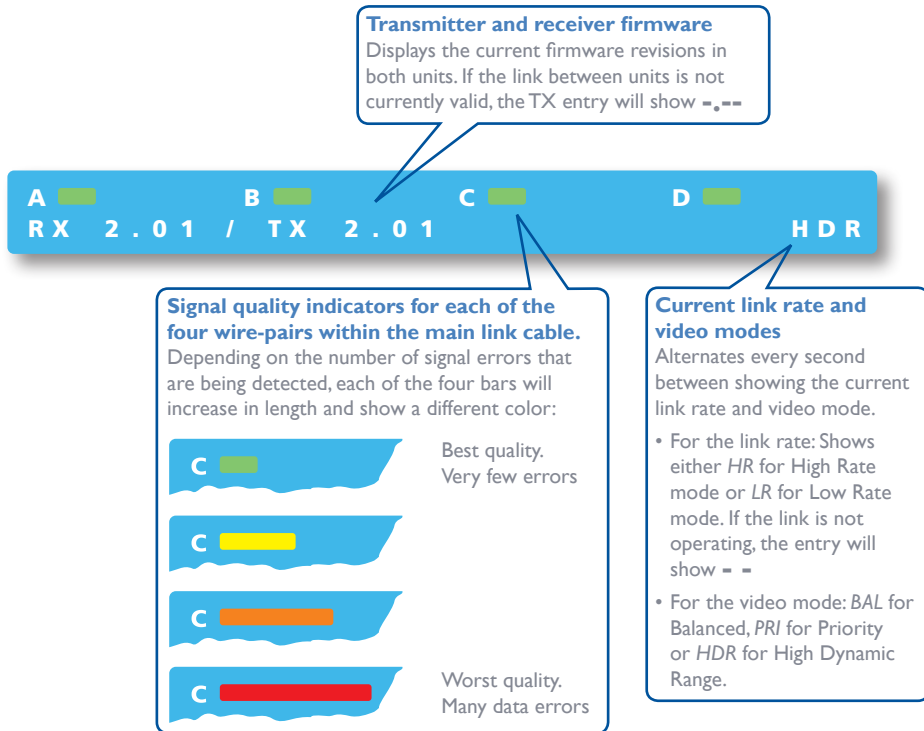

To display the Dashboard

- As discussed in more detail left, press **Ctrl** three times and then press **1**. The Dashboard will be shown at the top of the connected video display:



Transmitter and receiver firmware
Displays the current firmware revisions in both units. If the link between units is not currently valid, the TX entry will show --.

Signal quality indicators for each of the four wire-pairs within the main link cable.
Depending on the number of signal errors that are being detected, each of the four bars will increase in length and show a different color:

	Best quality. Very few errors
	
	
	Worst quality. Many data errors

Current link rate and video modes
Alternates every second between showing the current link rate and video mode.

- For the link rate: Shows either *HR* for High Rate mode or *LR* for Low Rate mode. If the link is not operating, the entry will show --.
- For the video mode: *BAL* for Balanced, *PRI* for Priority or *HDR* for High Dynamic Range.

- To remove the Dashboard, press **Ctrl** three times and then press **1**. The Dashboard will also disappear if you select any of the other hotkeys.

* When changing between preferred link rates, if a rate change subsequently occurs, the entire data link will be reset. This will cause a momentary loss of the video, audio and USB services. A successful switch to High Rate will only be possible if the link cable is able to support the higher rate - Please see [Tips for achieving good quality links](#) for further information.

This chapter contains a variety of information, including the following:

- Getting assistance - see right
- General specifications - see right
- [Appendix A](#) - Options port pin-out
- [Appendix B](#) - EDID management
- [Appendix C](#) - Tested video resolutions
- [Appendix D](#) - Link cable interference protection

GETTING ASSISTANCE

If you are still experiencing problems after checking the information contained within this guide, then please refer to the Support section of our website:

www.adder.com

GENERAL SPECIFICATIONS

Casing (w x h x d):	198mm (7.92") x 44mm (1.76") x 120mm (4.8")
Construction:	1U compact case, robust metal design
Weight:	0.75kg (1.65lbs)
Mount kits:	Rack mount - single or dual units per 1U slot. VESA monitor / wall mount chassis.
Power to adaptor:	100-240VAC 50/60Hz, 0.8A,
Power to unit:	5VDC 20W
Operating temp:	0°C to 40°C (32°F to 104°F)
Approvals:	CE, FCC

Options port pin-out

The Options port on each unit can accept either 8p8c or 10p10c connectors, as required.

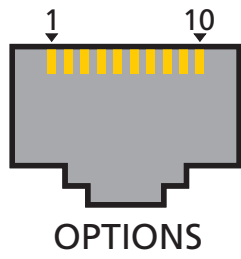

8p8c	10p10c	Signal
	1	Not used
1	2	5VDC power output (100mA max)
2	3	GND reference for all signals
3	4	RS232 (RXD) data receive
4	5	RS232 auxiliary data transmit (reserved)
5	6	RS232 auxiliary data receive (reserved)
6	7	RS232 (TXD) data transmit
7	8	Not used
8	9	Not used
	10	Not used

EDID management

This flowchart highlights how the AdderLink XD522 units determine which of the various modes reported by each video display can be supported by the installation.

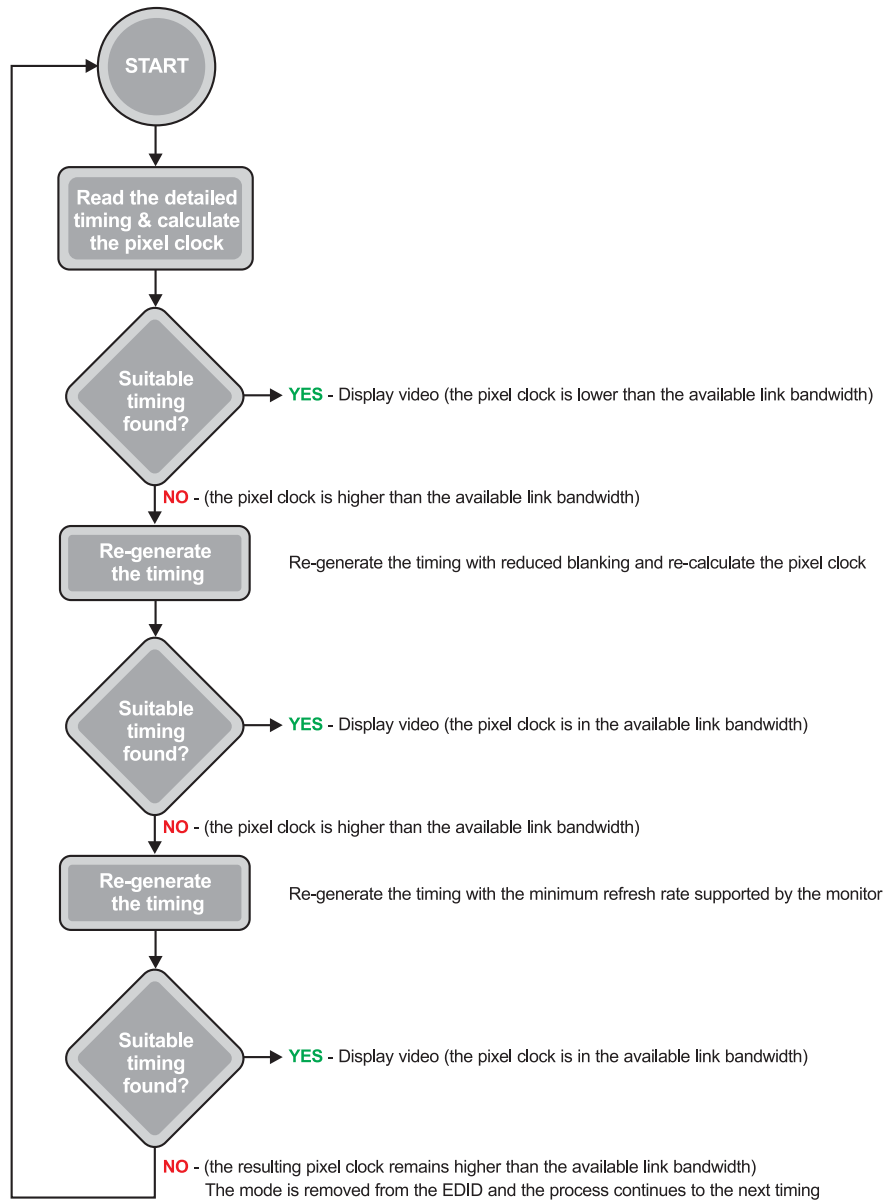

Tested video resolutions

This section details the video resolutions that have been tested with the AdderLink XD522 units and are known to work within the link limitations detailed elsewhere in this guide for the operational modes. All quoted video resolutions have reduced blanking.

Low Rate Mode

Maximum pixel clock: 148.5 Mpixels/sec

Video Head 1 video resolution

Max 148.5Mpix/Sec

2048x1080@60Hz	147Mpix/Sec
2048x768@60Hz	105Mpix/Sec
1920x1080@60Hz	138Mpix/Sec
1680x1050@60Hz	119Mpix/Sec
1600x1200@60hz	130Mpix/sec
1366x768@60Hz	85Mpix/sec
1280x1024@60Hz	109Mpix/sec
1024x768@60Hz	63Mpix/sec
800x600@60Hz	38Mpix/sec

High Rate Mode

Combined maximum pixel clock: 308 Mpixels/sec

Video Head 1 video resolution

Max 280Mpix/Sec

2048x2048@60Hz	279Mpix/Sec
2560x1600@60Hz	269Mpix/Sec
2560x1440@60Hz	242Mpix/Sec
3840x2160@30Hz	263Mpix/Sec
4096x2160@30Hz	280Mpix/Sec
2048x1080@60Hz	147Mpix/Sec
2048x768@60Hz	105Mpix/Sec
1920x1200@60Hz	154Mpix/Sec
1920x1080@60Hz	138Mpix/Sec
1680x1050@60Hz	119Mpix/Sec
1600x1200@60hz	130Mpix/sec

Video Head 2 video resolution

Max 154Mpix/Sec

Not supported	
Not supported	
Not supported	
Not supported	
2048x1080@60Hz	147Mpix/Sec
2048x768@60Hz	105Mpix/Sec
1920x1200@60Hz	154Mpix/Sec
1920x1080@60Hz	138Mpix/Sec
1680x1050@60Hz	119Mpix/Sec
1600x1200@60hz	130Mpix/sec

Note: Entering balanced mode will limit the supported video display resolutions up to and including 1920x1200@60Hz (154Mpixels per second), even if the connected monitors are capable of supporting higher resolutions.

Link cable interference protection

While the Category rating (e.g. CAT 5e, CAT 6a, etc.) determines the electrical performance of a cable, another vital part of the overall cable specification is its protection from interference. As cabling distances and data rates increase, so too does the susceptibility to interference, from both external and internal sources.

Proximity to other electromagnetic sources are the main external threat and these can be subdued using overall screening that surrounds all four of the cable pairs. However, interference is also possible from neighbouring twisted pairs within the same cable and this can be just as hazardous to data integrity. Such *crosstalk* is countered by shielding each cable pair separately.

Within each Category rating, you can specify different combinations of external screening and internal shielding to suit the environment into which the link is being placed. Please see the section [Tips for achieving good quality links](#) for suggested combinations.

Interference protection codes

Interference protection is now classified in the following manner:

U/UTP

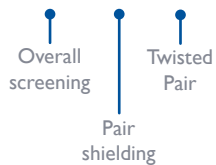

where

U = unshielded

F = foil shielding

S = braided shielding

PiMF = Pairs in Metal Foil

Name	Overall Screening	Pair Shielding
U/UTP	✗	✗
F/UTP	✓	✗
U/FTP	✗	✓
S/FTP or S/STP or PiMF	✓	✓

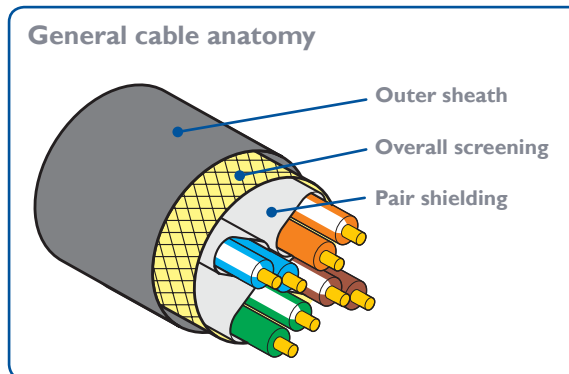
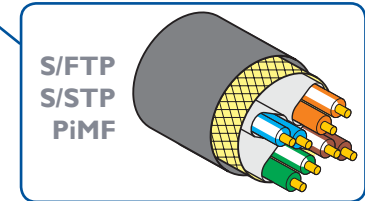
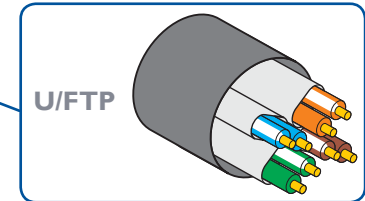
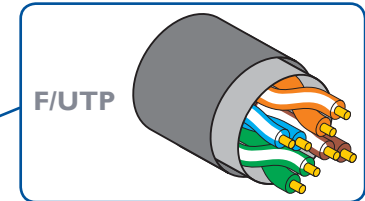
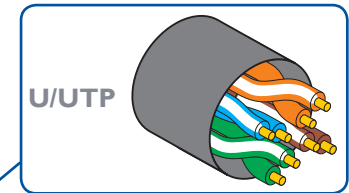

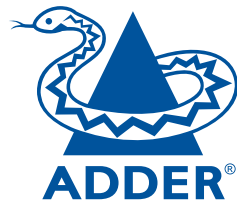

www.adder.com

Documentation by:



www.ctxd.com

© 2021 Adder Technology Limited
All trademarks are acknowledged.
Part No. MAN-XD5x2-ADDER • Release 1.4

A

Analogue audio 11
Audio
 hotkey switch 16
 RX connections 16
 TX connections 11
Audio input mode 20
Audio support 4

B

Bandwidth
 video 3

C

Cable pairs 27
Cables
 included 7
 optional 8
Category rating 27
CATx links 5
Crosstalk 27

D

Dashboard 22
Digital audio 11,17
DisplayPort
 TX connections 10
DP++ 14
DVI
 adapter 14

E

EDID 25,26,27
EDID management 3

F

Flash upgrade 20
Front panel indicators 21

G

Getting assistance 23

H

HDMI
 adapter 14
High Rate mode 3,22
Hotkeys 22
Hotkey switch
 audio 16
HR 21

I

Indicators 6,21
Interference
 protection 27

L

Line In 20,22
Link
 RX connections 18
 TX connections 12
Link quality 5
Low Rate mode 3,22
LR 22

M

Microphone 20,22
mini-TOSLINK
 fibre connector 11
Mounting 9

O

Operating Modes 21
Options port
 pin-out 24,25,26,27

P

Patch cable 5
Power
 RX connection 19
 TX connection 13

R

Resolutions
 video 3
RS232 12,18

S

Screening 27
Serial
 RX connection 18
 TX connection 12
Serial comms 4
Shielding 27
Size 23
Specifications 23

T

Temperature
 operating 9,23
TOSLINK
 fibre connector 11

U

Upgrade 20
USB 4
 RX connections 15
 TX connections 10

V

VGA
 adapter 14
Video
 modes 3
 RX connections 14
 TX connections 10
Video bandwidth 14

W

Weight 23