

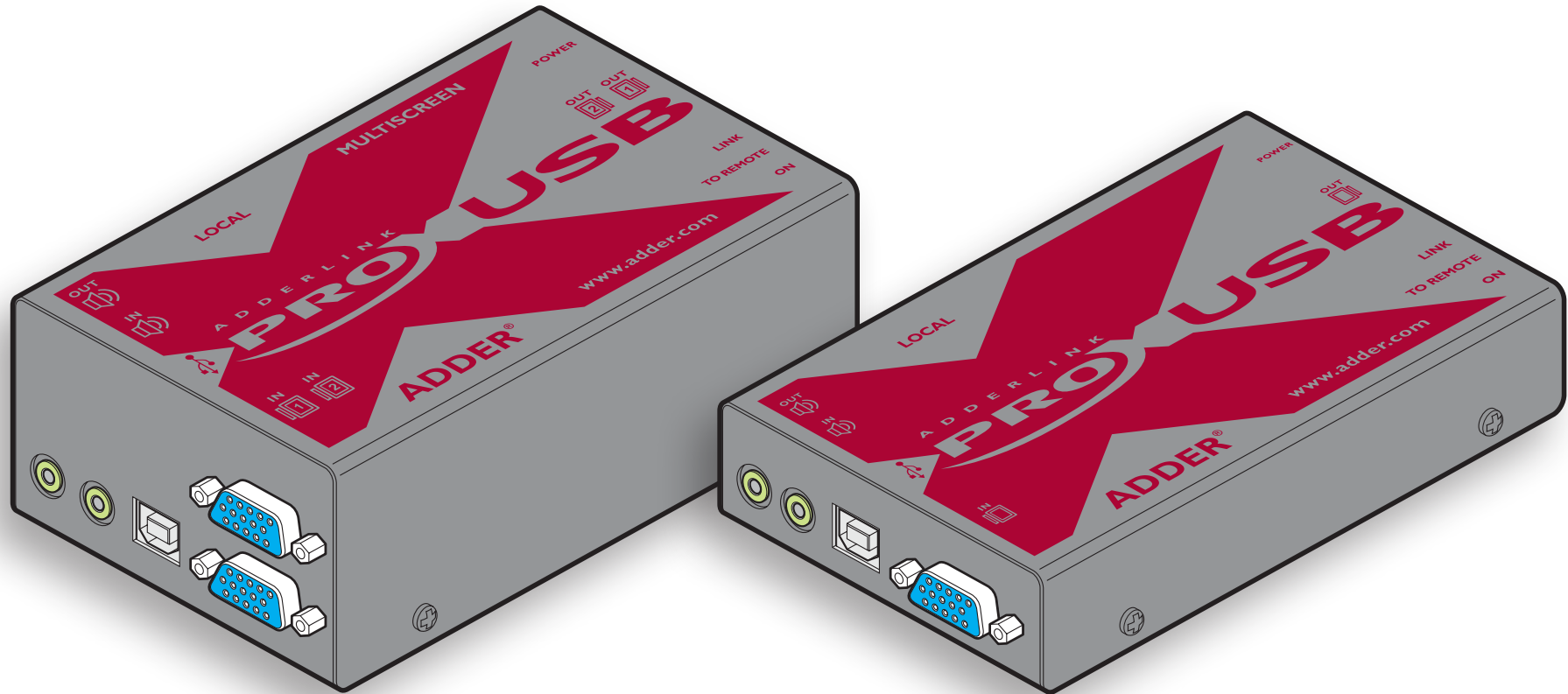

AdderLink X-USBPRO

Analog video and USB extenders



CONTENTS

Contents



Welcome

Introduction	2
Supplied items	3
Optional items	4

Installation

Connections	5
Mounting	5
Connections at the local module	6
Local module power connection	8
Connections at the remote module	9
Dual user configuration	12
Video display (DDC) information	13
Video compensation	14
What is skew and why is compensation needed?	16

Operation

General use	17
Dual user arbitration	17
Peripheral operation	17

Further information

Getting assistance	18
Troubleshooting	18
Warranty	19
Safety information	19
Radio Frequency Energy	20

CONTENTS
WELCOME
INSTALLATION
OPERATION
FURTHER INFORMATION

Welcome



Introduction

Thank you for choosing the AdderLink X-USBPRO or X-USBPRO-MS2 extenders which provide a very effective way to put distance between your computer and its peripherals.

The compact casings and ease of use of the modules belie the ingenuity of their operation. Using our proprietary transmission techniques we are able to reliably transfer more signals than ever before along a single length of Category 5, 5e, 6, 7 or 7a twisted pair cabling. What this means for you is that your video, audio, USB keyboard, USB mouse and two other USB channels are all readily and reliably available at up to 300 metres away.

Using the Adder X-USBPRO extenders does not mean that you need to compromise on functionality in any way. Our highly efficient transmission methods mean that CD quality sound and high video resolutions of up to 1920 x 1200 are fully supported. Any lag effects caused by long cable runs are easily eliminated using the intuitive video compensation system located within the remote module. Three equalisation bands allow you to ensure that every colour arrives at precisely the right time, ensuring a sharp image every time. The X-USBPRO-MS2 model uses an additional CATx connection to provide dual analog video links.

The USB connections are seamless allowing four full speed USB 2.0 devices to be used simultaneously with full support for disconnect/re-connect at any time without causing errors.

The Adder X-USBPRO extenders have been designed to be quick to install and totally transparent in operation: 'Fit and forget' is the motto. So whether you are extending your workplace or creating a cost-effective distributed audio visual system, the X-USBPRO extenders provide the power and flexibility to create the right solution.

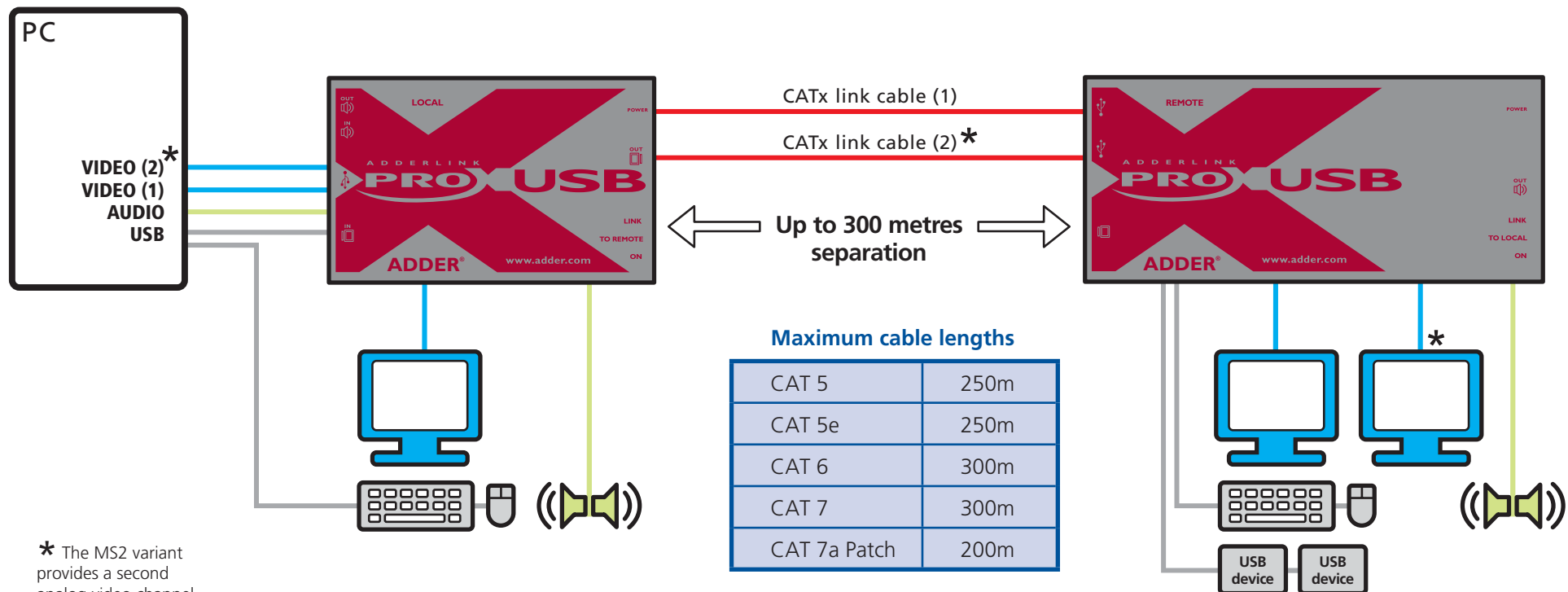

CONTENTS

WELCOME

INSTALLATION

OPERATION

FURTHER INFORMATION

Supplied items

AdderLink X-USBPRO extender modules

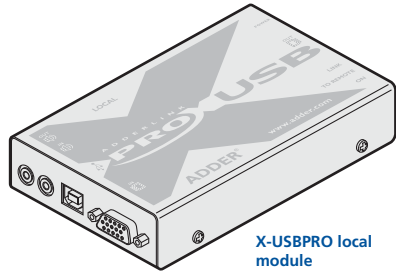

X-USBPRO local module

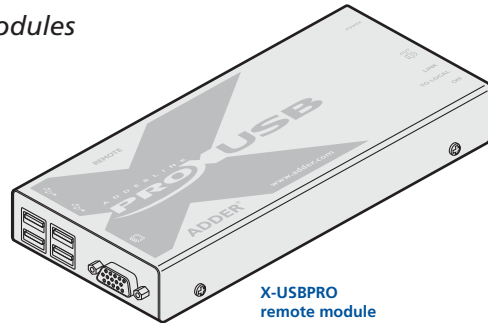

X-USBPRO remote module

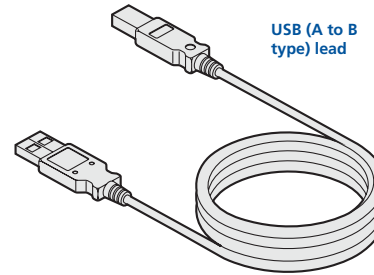

USB (A to B type) lead

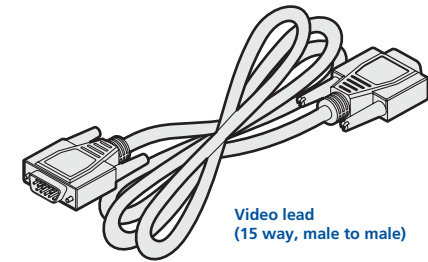

Video lead (15 way, male to male)

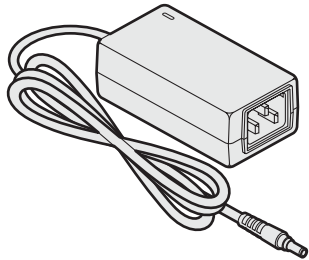

Power adapter and country-specific power lead (for remote module)

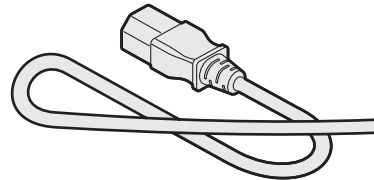

Audio lead (3.5mm jacks)

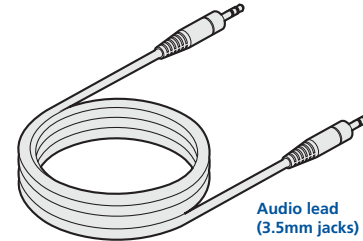

Information wallet containing:
Eight self-adhesive rubber feet
Safety document

AdderLink X-USBPRO-MS2 dual video extender modules

The MS2 variant package includes all of the above ancillary items plus:

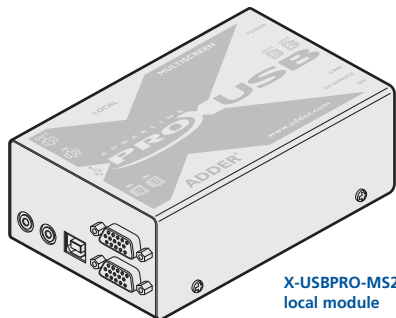

X-USBPRO-MS2 local module

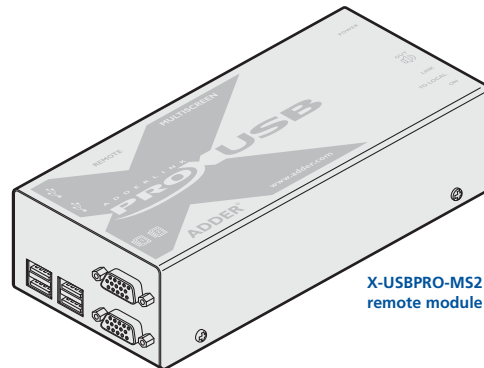

X-USBPRO-MS2 remote module

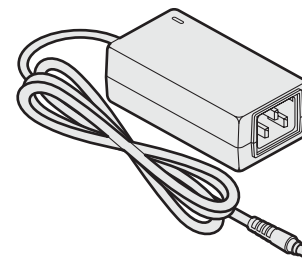

Power adapter and country-specific power lead (for MS2 local module)

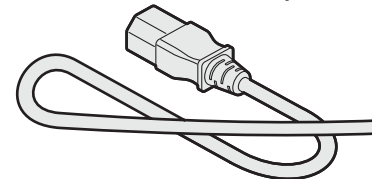

Video lead (15 way, male to male)

Optional items

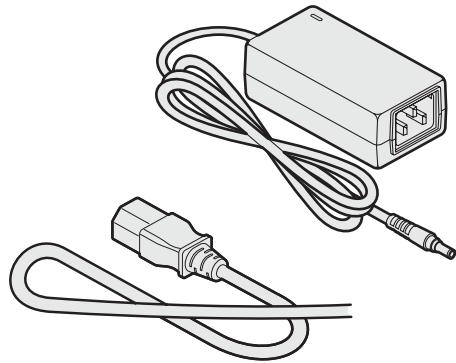

Power adapter for local module (if USB powering not possible)

Part number: PSU-IEC-5VDC-2.5A

Country-specific power cords

- CAB-IEC-AUS (Australia)
- CAB-IEC-EURO (Central Europe)
- CAB-IEC-UK (United Kingdom)
- CAB-IEC-USA (United States)
- CAB-IEC-JAPAN (Japan)

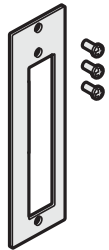

Rack mount plate for X-USBPRO module
(useable for the local or remote modules)
Part number: X-RMK-FASCIA

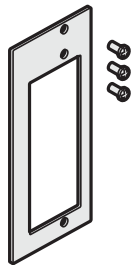

Rack mount plate for X-USBPRO-MS2 module
(useable for the local or remote modules)
Part number: X-RMK-FASCIA-DUAL

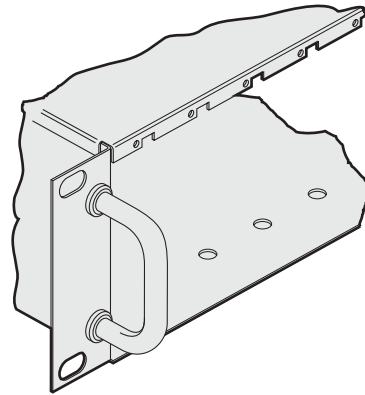

Rack mount chassis
Part number: X-RMK-CHASSIS

Installation

Connections

Installation of the X-USBPRO modules is straightforward with minimal configuration requirements in most cases.

- [Connections at the local module](#)
- [Connections at the remote module](#)

Important

The X-USBPRO can be used with other USB hubs in the system, but please note that due to power constraints, the local unit should not be connected to the downstream port of a bus-powered USB hub. Additionally, X-USBPRO-MS2 local units must always be powered using their supplied power adapter. Please see page 8 for details.

Mounting

The X-USBPRO modules offer two main mounting methods:

- Supplied four self-adhesive rubber feet
- Optional rack mount brackets - see below

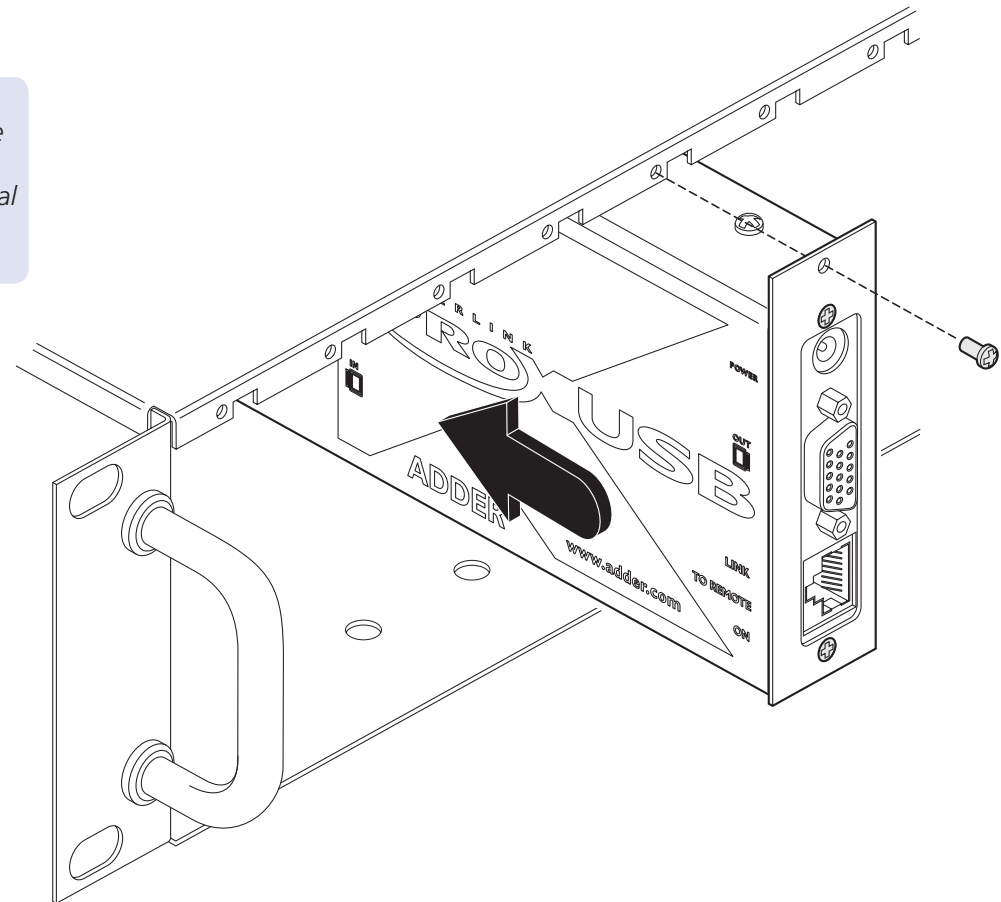

Connections at the local module

- 1 Where possible ensure that power is disconnected from the computer system to be connected.
- 2 Use the supplied video lead to link the video input socket of the local module to the video output port of the computer.

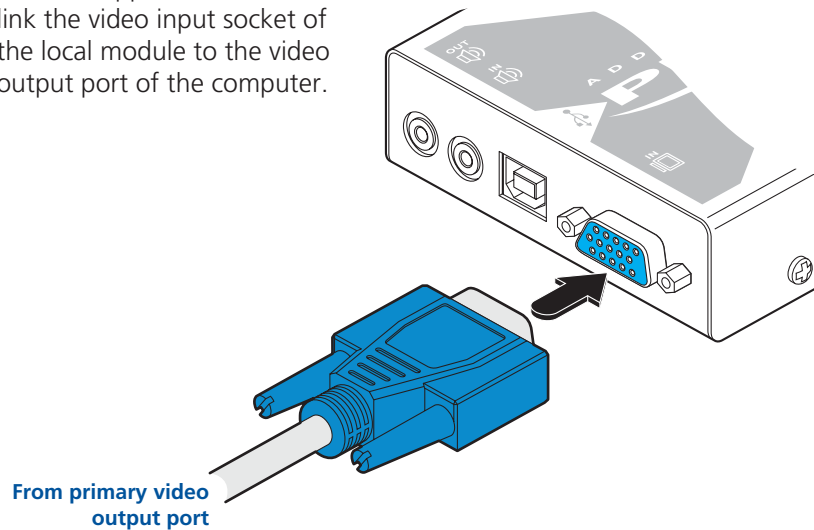

[MS2 variant only] Optionally attach a second video input to the upper video in socket on the MS2 local module.

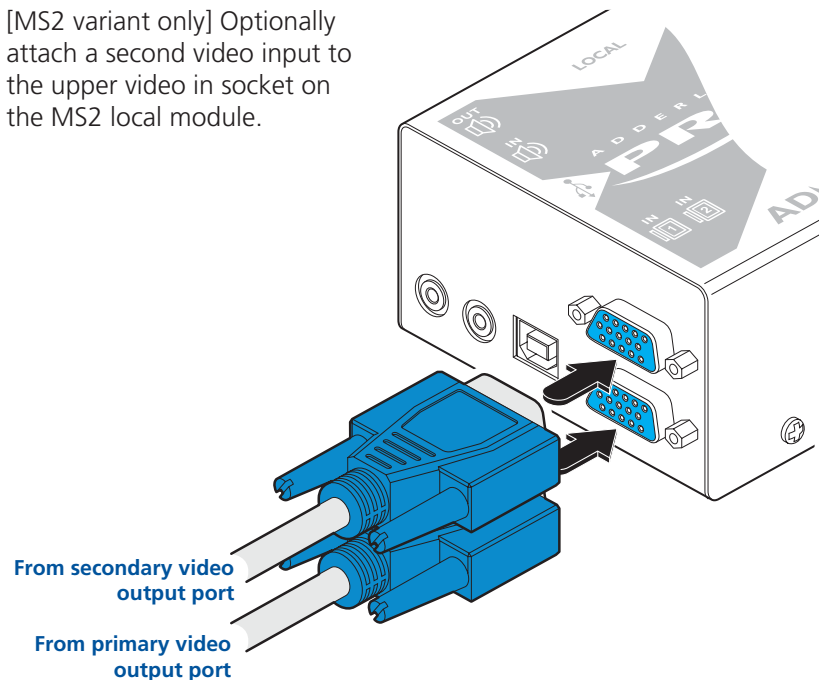

- 3 Use the supplied USB cable to link the USB socket of the local module to a vacant USB socket on the computer.

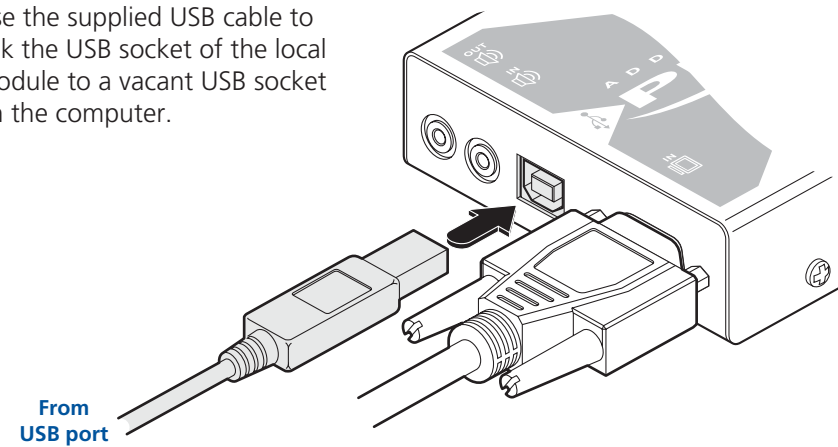

Note: Do not use USB cables longer than 3 metres to connect the local module to the computer.

Important

The X-USBPRO can be used with other USB hubs in the system, but please note that due to power constraints, the local unit should not be connected to the downstream port of a bus-powered USB hub. Additionally, X-USBPRO-MS2 local units must always be powered using their supplied power adapter. Please see page 8 for details.

- 4 Optionally connect an audio link from the computer's speaker port to the audio input port on the local module.

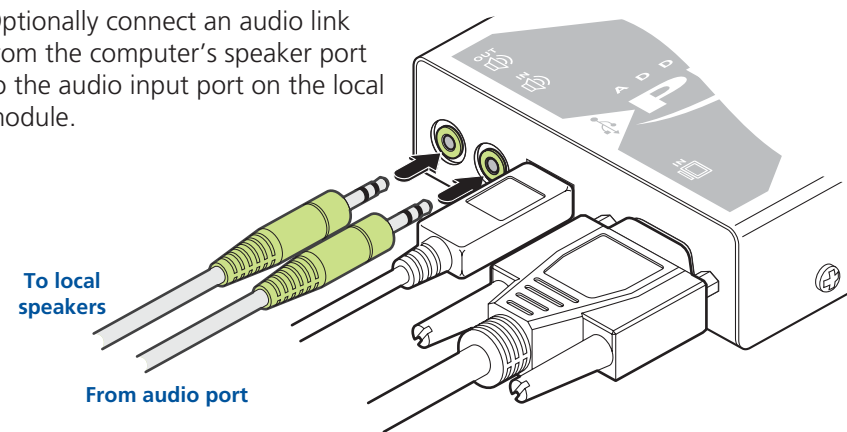

- 5 Optionally connect local speakers to the audio output port on the local module.

- 5 Connect a category 5, 5e, 6, 7 or 7a link cable (up to 300 metres in length) to the 'TO REMOTE' socket on the local module.

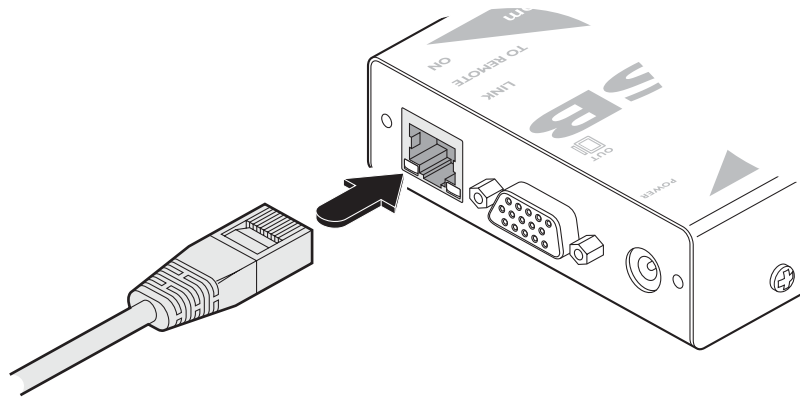

Link to remote module

- 6 Optionally connect a local video display to the video out feed-through connector on the local module.

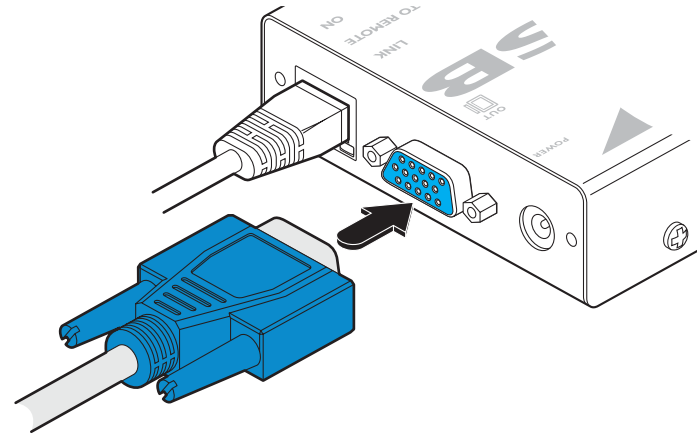

To local video display

[MS2 variant only] Connect a second category 5, 5e, 6, 7 or 7a link cable (up to 300 metres in length) to the upper socket on the MS2 local module.

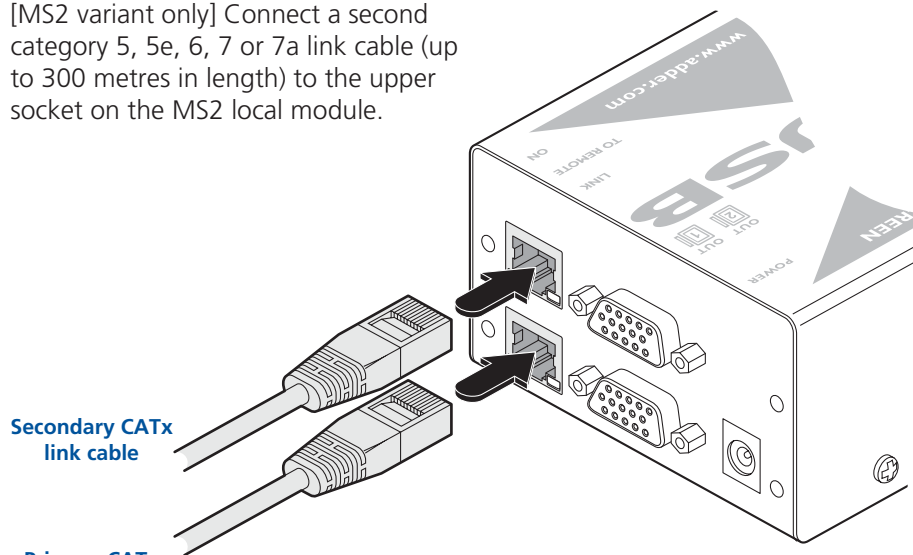

Secondary CATx link cable

Primary CATx link cable

Note: Ensure that the primary and secondary links to the remote module are not crossed.

[MS2 variant only] Optionally connect a second local video display to the upper socket on the MS2 local module.

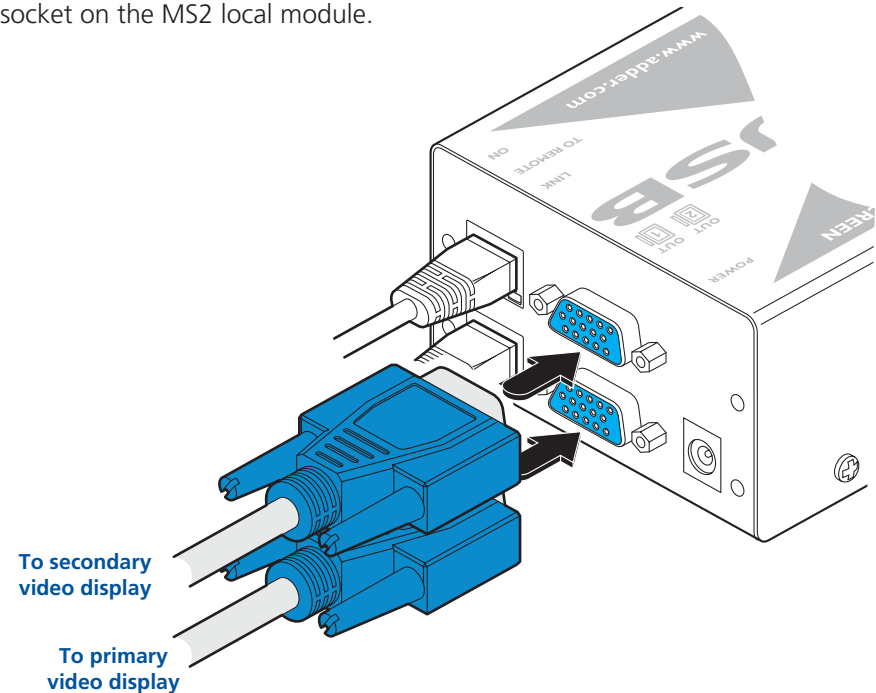

To secondary video display

To primary video display

Local module power connection

The standard X-USBPRO and the X-USBPRO-MS local modules differ in the way that they are powered:

- The X-USBPRO local module is designed to derive its power from the host computer via the USB connection. If this is not possible, then use an optional Adder power adapter (part number: PSU-IEC-5VDC-2.5A), available from your Adder stockist
- The X-USBPRO-MS2 local module always requires the use of a power adapter and hence two power adapters are supplied with all X-DVIPRO-MS2 units.

For all X-USBPRO-MS2 and optionally for X-USBPRO units:

- 1 Connect the output lead of the optional power adapter to the socket labelled 'POWER' on the local module.

X-USBPRO: Use an optional power adapter only if power from the host (via USB) is not possible.

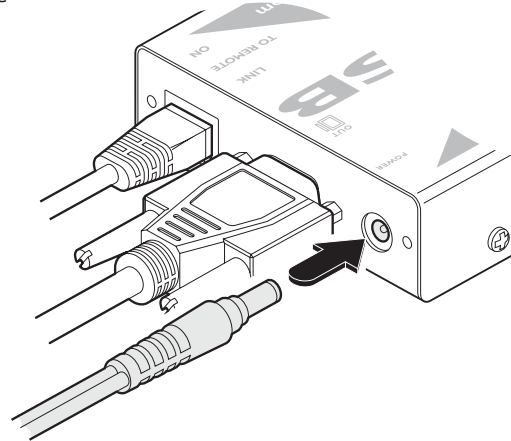

Note: After all connections are made, power up the monitor and the REMOTE module first (followed by the LOCAL module, if using the X-USBPRO-MS2 variant) and then switch on the computer.

X-USBPRO-MS2: Use the supplied power adapter for all installations.

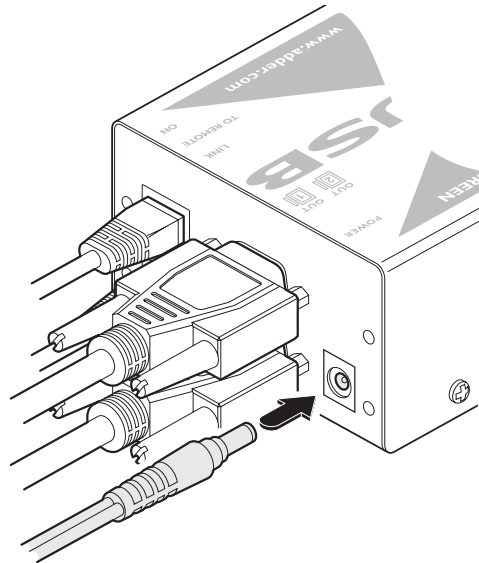

- 2 Insert the IEC connector of the separate power lead into the corresponding socket of the power adapter.

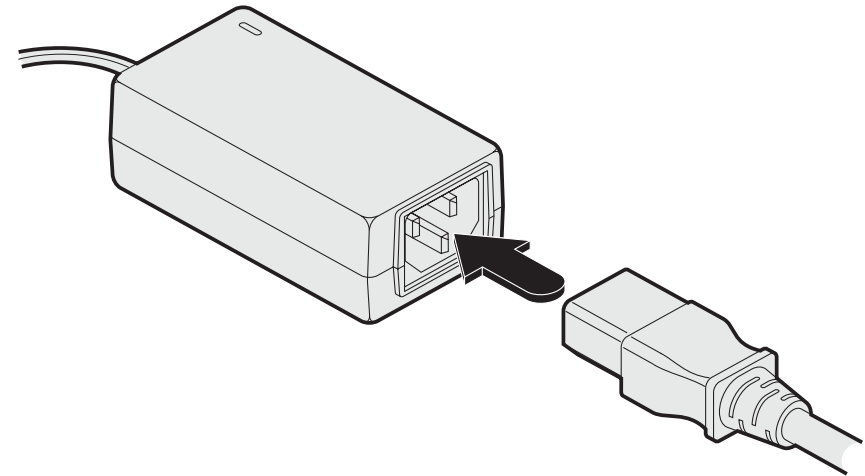

- 3 When all other connections have been made at the transmitter and receiver modules, connect the other end of the power cable to a nearby earthed power outlet.

Connections at the remote module

- 1 Place the remote module adjacent to the user location.
- 2 Attach the leads of up to four USB devices (two of which are usually a keyboard and mouse) to the sockets located adjacent to the video output connector.

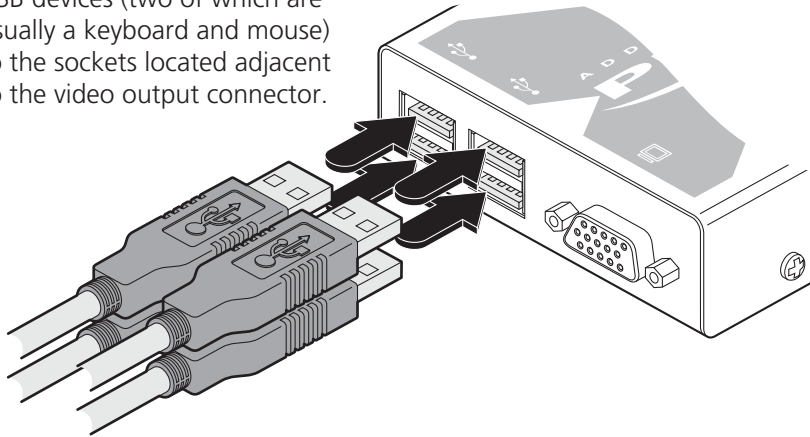

- 3 Attach the lead from the video display to the video out socket on the remote module.

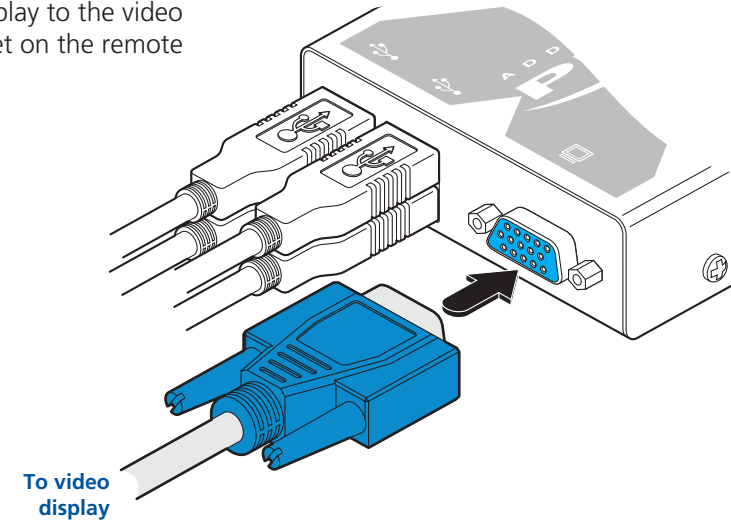

[MS2 variant only] When connecting four USB devices to the unit, ensure that their total power requirements do not exceed 1700mA (1.7A). The USB standard states a maximum allowable current draw of 500mA (0.5A) per device, although most devices remain well below this limit - USB keyboards and mice typically require 100mA. Each X-USBPRO contains a self-resetting fuse that will prevent damage by shutting down the unit if the total power draw becomes excessive.

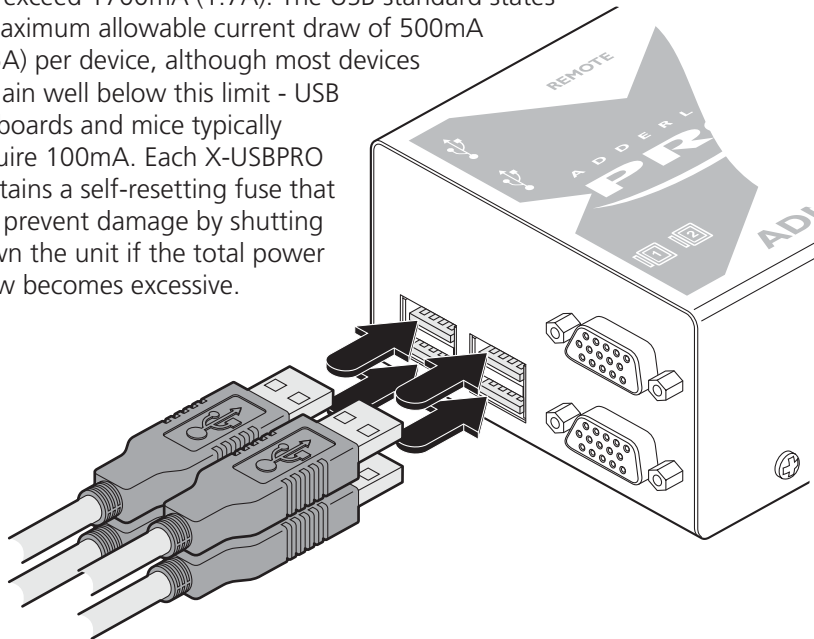

[MS2 variant only] Optionally attach the lead from a second video display to the upper video out socket on the MS2 remote module.

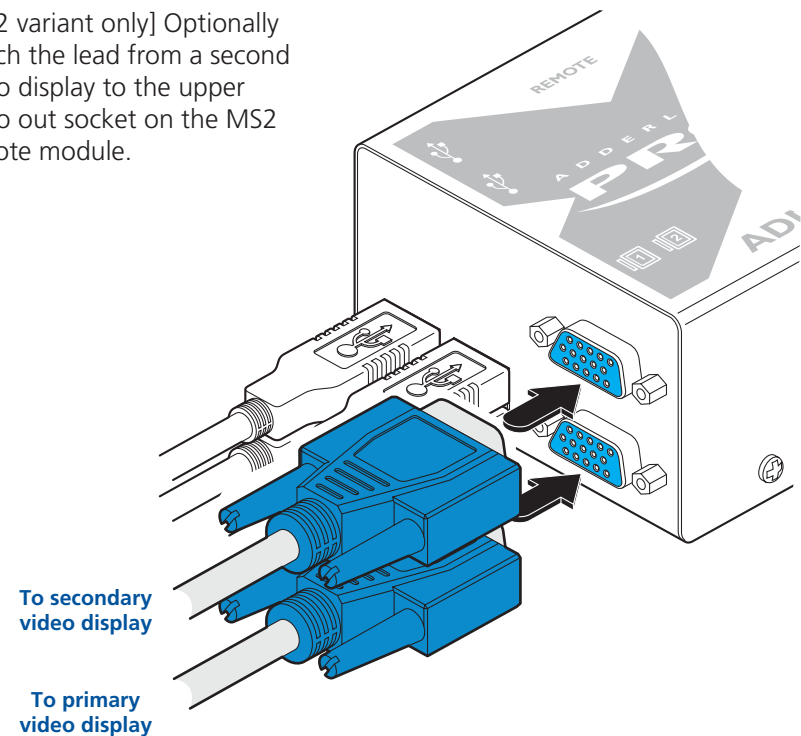

- Attach the connector of the category 5, 5e, 6, 7 or 7a link cable (up to 300 metres in length) to the 'TO LOCAL' socket on the remote module.

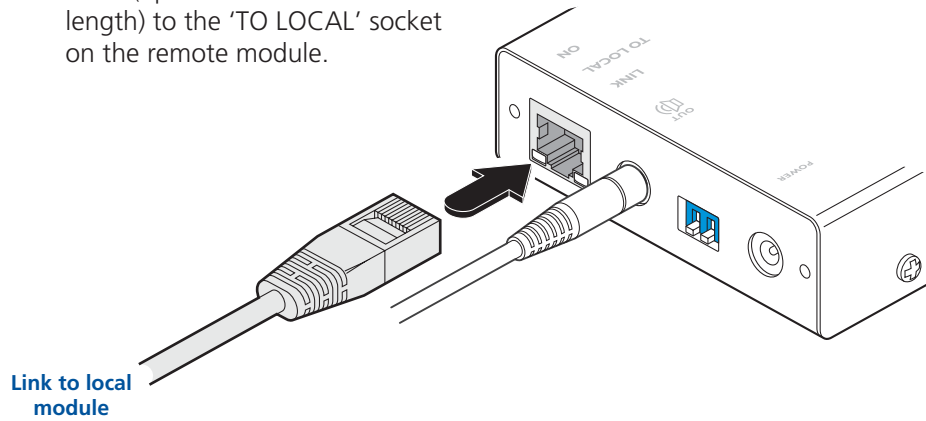

- Optionally attach the lead from your stereo speakers to the audio output socket on the remote module.

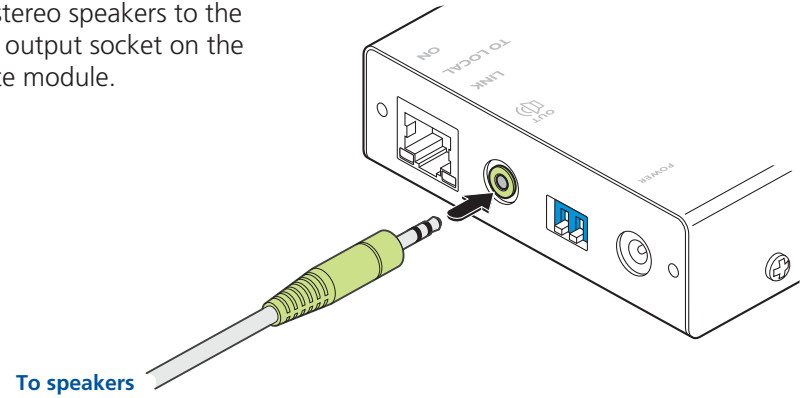

[MS2 variant only] Connect a second category 5, 5e, 6, 7 or 7a link cable (up to 300 metres in length) to the upper socket on the MS2 remote module.

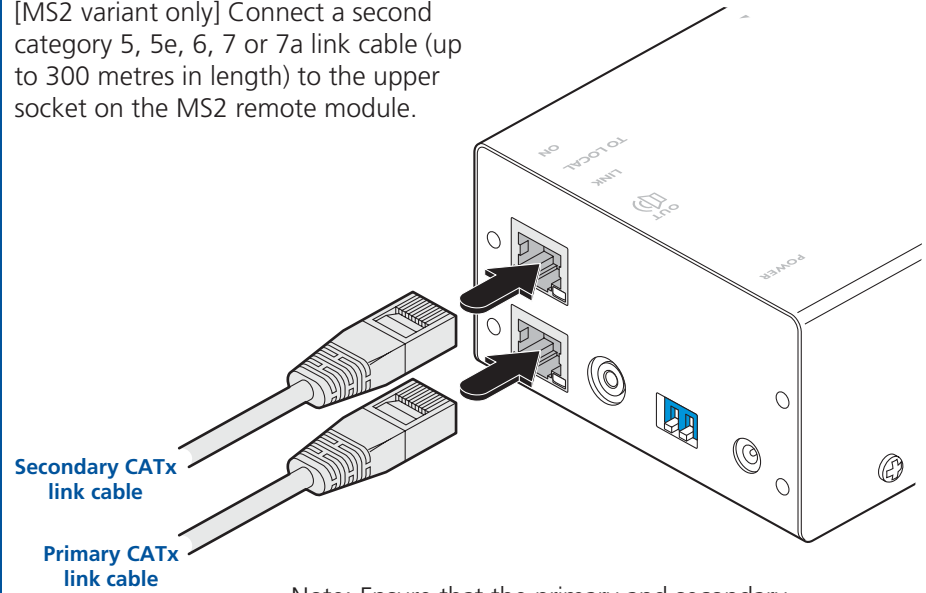

Note: Ensure that the primary and secondary links from the local module are not crossed.

continued



- CONTENTS
- WELCOME
- INSTALLATION
- OPERATION
- FURTHER INFORMATION

- 6 Attach the output connector of the power supply to the 'POWER' socket of the remote module.

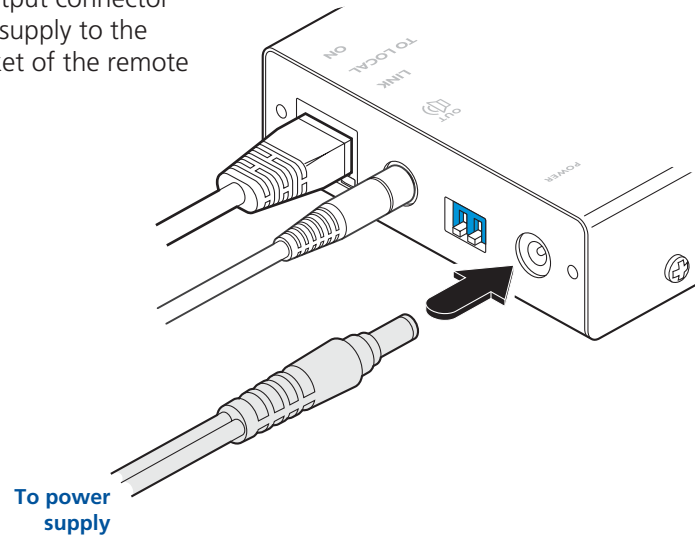

- 7 Attach the IEC power lead to the power supply body and insert the mains plug of the lead to a nearby earthed power outlet.

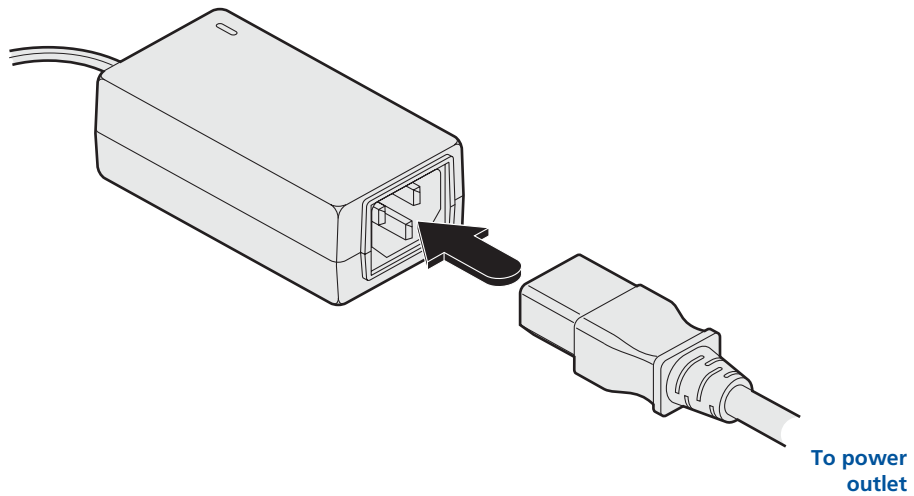

Dual user configuration

You can combine two Adder X-USBPRO (or X-USBPRO-MS2) extender sets to create a dual user configuration. Such an installation would allow a single computer to be controlled from two different positions, with each position receiving the same audio visual output and having equal and concurrent control over the computer. Arbitration between the two positions is handled by the computer's USB system and so this arrangement is better suited to situations where two users would not often require simultaneous access.

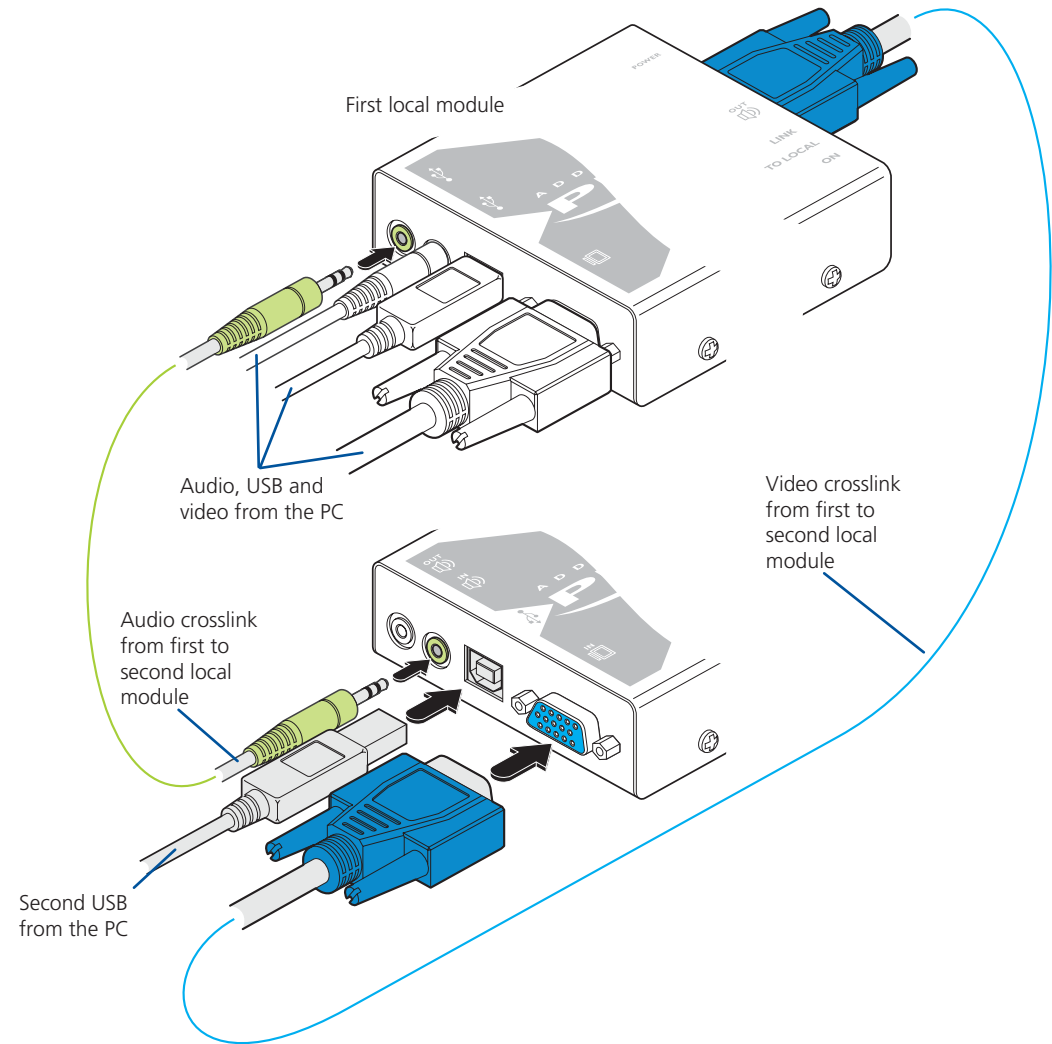
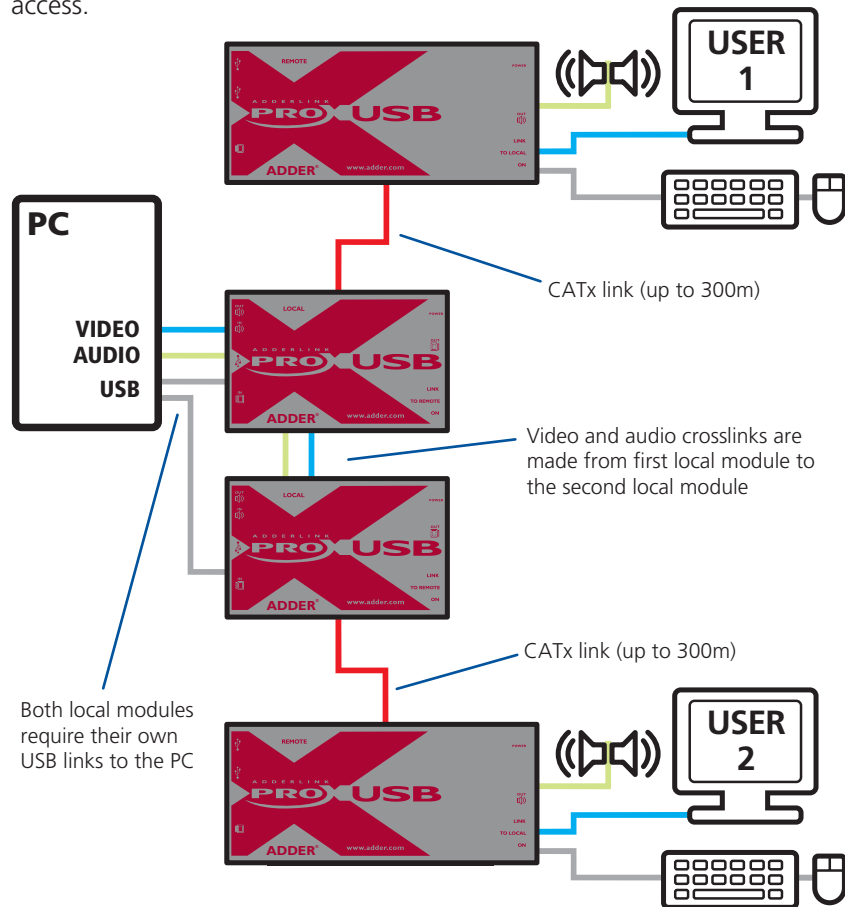

Most of the connections are similar to the standard configuration. The main difference is in the links to the second local module. Use an audio link lead to connect the audio out socket of the first local module to the audio in socket of the second. Similarly, use a video link lead to connect the video out and video in ports. The second local module then requires its own USB link directly to the computer. In all other respects follow the standard instructions to connect CATx links and all of the remote module connections.

Video display (DDC) information

The Display Data Channel (or DDC) is an industry standard scheme that allows video displays to declare their capabilities to the computer's video adapter circuitry, allowing the latter to optimise their outputs accordingly. Since the widespread adoption of the scheme, video adapters have become increasingly dependent on receiving relevant DDC information during startup, before they will output anything more than a rudimentary video signal.

It is not possible to transmit DDC data back from the video display that is attached to the remote module to the computer's video adapter. Therefore, during startup of the local module, it will search for a video display connected to its local feed-through connector:

- If a local video display is found, its DDC information will be compared to the information already stored and, if different, will be copied, stored and presented to the video adapter upon request.
- If no local video display is found, the local module will make available its previously stored set of DDC parameters to the video adapter upon request; or, if none were stored, a default set.

In either case, the DDC information taken by the video adapter will be used to determine the video output that is sent via the X-USBPRO modules to the remote video display.

If you find that the default DDC information is not completely suitable for your remote display, try temporarily connecting your remote display to the video out port of the local module. When the local module is powered up, it will read and store the DDC information from your display. You can then return the display to its remote position and the new DDC information will be used at every power on.

Note: For MS2 variants, the dual video channels are handled separately. Therefore, if you wish to capture both sets of DDC information, you will need to temporarily connect both of your remote video displays to the video output ports of the local module.

DDC indications

When power is first applied to the local module (either from the computer's USB port or an optional power adapter) it will search for valid DDC data on its video out connector. During this process, the green indicator (built into the link connector) will flash to indicate its progress:

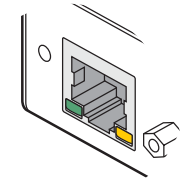

- If no valid DDC information is located, the green indicator will give one very short flash, representing an attempt to read data. No changes will be made to the information already stored within the local module.
- If the DDC information is the same as that already stored, no change will be made and the green indicator will give one single flash as the information is checked and normal operation resumes.
- If different DDC information is located, the green indicator will flash rapidly for 2 to 3 seconds while the new information is stored. A single flash will then be given as the information is checked and normal operation resumes.

The local module's green indicator also provides fault indications to assist with troubleshooting:

- Two flashes - Checksum error prior to copying - no information will be programmed.
- Three flashes - Too much data to fit into the module - the module can hold a maximum of two pages of DDC information.
- Rapid flashing followed by four flashes - data was lost during copying - the default data was substituted. Repeat the power on process.
- Rapid flashing followed by five flashes - Checksum error during copying - the default data was substituted. Repeat the power on process.

Video compensation

The X-USBPRO modules include a video compensation system that allows you to get the best results from your remote video display(s). Using this special mode you can configure:

- **Cable type** - Select the type of link cable used.
- **Cable length** - Enter the length of the link cable.
- **Video gain** - Alter the signal gain for the image.
- **Colour skew** - Adjust the timing of each colour to fine tune the image.

To enter video compensation mode

- 1 Ensure that the two X-USBPRO units are connected to the computer and powered on. A USB keyboard must be connected to the remote unit.
- 2 Arrange your test images on the remote screen. Please refer to the section [Test images while compensating](#).
- 3 On the remote unit, click the miniature switch **1** to its ON position.

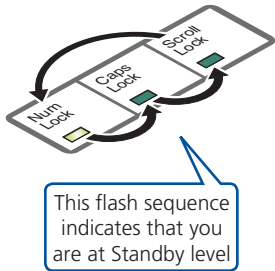
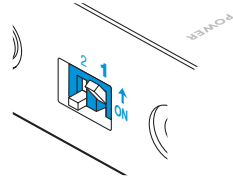

The indicators on the keyboard linked to the remote unit will begin to flash in sequence. Also, the green indicator adjacent to the CATx link socket will flash.

Note: During video compensation mode, the keyboard and any other connected USB devices will be temporarily isolated from the computer.

You are now at the **standby level** within video compensation mode.

From standby, you can choose which adjustments to make. Generally you should set the cable type and cable length options first. Then, if necessary, use the video gain and colour skew adjustments to fine tune the remote video image.

[Please see the next page for details about each adjustment >>>](#)

When your adjustments are complete, return the unit to normal operation as described right.

To exit video compensation mode (return to normal operation)

- 1 Ensure that you are at standby level by exiting from any adjustment options.
- 2 On the remote unit, return the miniature switch **1** to its OFF position. All USB devices will be reconnected to the computer and normal operation will continue.

MS2 variants By default, all video compensation changes that you make will affect both channels equally. If you wish to adjust the channels separately:

- Enter video compensation mode (see left). The green indicators on both link sockets of the remote module will flash.
- From standby, press **H**. The keyboard indicators will alternate between the Num Lock and Scroll Lock, and the Caps Lock. Press **1** or **2** to select the primary or secondary video display, respectively. The green indicator of the link socket corresponding to the chosen video channel will flash (lower=primary, upper=secondary), the other will remain on.
- Make the required compensation changes to the chosen video channel using the techniques described below.
- To return to using both channels, from standby, press **H** and then press **0**. The green indicators of both link sockets will flash.

Video compensation (continued)

Once you have [entered video compensation mode](#), you can choose which adjustments to make. Generally you should set the cable type and cable length options first. Then, if necessary, use the video gain and colour skew adjustments to fine tune the remote video image.

To set the cable type

- From standby, press **C**. The Num Lock and Caps Lock indicators will flash.
- Type the number that corresponds to the category of link cable used:
 - Press **1** for **Cat 5**
 - Press **2** for **Cat 5e**
 - Press **3** for **Cat 6**
 - Press **4** for **Cat 7**
 - Press **5** for **Cat 7a**
- Press **Enter** to save the value and return to standby. Alternatively, press **Esc** to discard any change and return to standby.

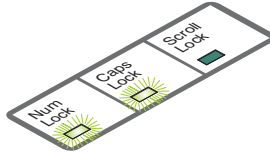

To set the cable length

- From standby, press **L**. The Caps Lock and Scroll Lock indicators will flash.
- Use the keypad to enter the cable length in metres.
- Press **Enter** to save the value and return to standby.
Alternatively, press **Esc** to discard any change and return to standby.

*Note: You can also increase or decrease the cable length setting from the standby level (and view the resulting change in screen image quality) using **↑** and **↓** respectively. If necessary, press **Home** to return to a neutral setting. Such adjustments to the cable length setting are saved automatically.*

To adjust video gain

- From standby, use **←** and **→** to decrease or increase the gain level. If necessary, press **Home** to return to a neutral setting. Gain adjustments are saved automatically.

continued

To adjust colour skew

You will only need to use these adjustments if the video image is not sharp after adjusting the cable type and length. Before entering video compensation mode, display the suggested screen content (see *Test images while compensating* in the box right). Look for colour fringes adjacent to the displayed icons and text. Also check the Adder test pattern generator image to confirm whether the red, green and blue crosses are all vertically aligned.

- From standby, press either **R**, **G** or **B** depending on which colour needs to be adjusted. The Num Lock, Caps Lock or Scroll Lock indicators will flash for the Red, Green and Blue channels respectively.
- Use **←** and **→** to adjust the delay for the chosen colour while watching the results on the remote video display.

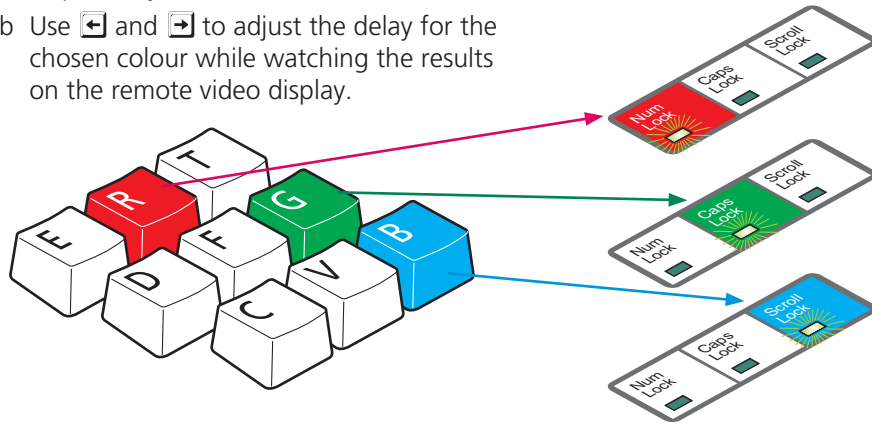

*Note: If the screen goes blank during adjustment, either press the opposite arrow key to the one you last pressed or press **Home** to reset all delays.*

- Press **Enter** to save the setting and return to standby.
Alternatively, press **Esc** to discard any change and return to standby.

To exit video compensation mode (return to normal operation)

- Ensure that you are at standby level by exiting from any adjustment options.
- On the remote unit, return the miniature switch **1** to its OFF position.
All USB devices will be reconnected to the computer and normal operation will continue.

What is skew and why is compensation needed?

The twisted pair cabling supported by the X-USBPRO modules consists of four pairs of wires per cable, three of which are used to convey red, green and blue video signals to the remote video display. Due to the slight difference in twist rate between these three pairs, the red, green and blue video signals may not arrive at precisely the correct times. This is visible as separate colour shadows on high contrast screen images. This effect is particularly apparent when using higher screen resolutions and some types of category 5e cables.

The video compensation system within the remote module allows you to delay or advance the timing of any of the colour signals so that they all arrive at the display at the correct times.

Take a close look at a locally connected display. From left to right, groups of pixels are usually arranged in the order: R / G / B and the signals must arrive in the correct order to obtain the optimum screen image. The Adder test pattern generator (see box below) in particular helps to highlight the pixel layout by showing very narrow horizontal and vertical lines.

To obtain and run the free Adder test pattern generator

- Visit www.adder.com.
- Click the **PRODUCTS** heading and then choose **Management Software**.
- From the list of software utilities, choose the **ADDER Test Pattern Generator** option.
- Click the **Downloads** tab and choose the **ADDER Test Pattern Generator** option to download the utility.
- Unzip the downloaded file and run the **TESTpatterns.exe** file.
- Click the **SKEW** option.

Test images while compensating

For best results while adjusting video compensation, arrange a combination of elements on the remote display. We suggest the following:

- Roughly half of the screen to display standard operating system colour icons on a mid-green wallpaper.
- A quarter screen of the Adder test pattern generator.
- A quarter screen of standard black text on a white background.

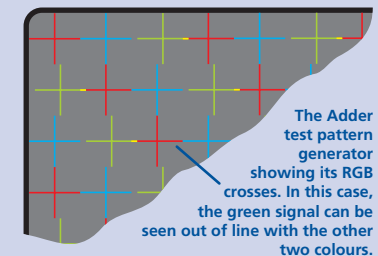

Note: You need to set all of the above BEFORE entering video compensation mode because the USB keyboard will be isolated from the computer.

Operation



General use

In use, the X-USBPRO (and X-USBPRO-MS2) modules should be transparent - the system and its peripherals should operate exactly as normal, the only difference being that they are now up to 300 metres apart.

In some installations, you may see some 'shadows' to the right of high contrast screen characters. This can be caused by an incorrect video compensation setting and it may be necessary to make adjustments to correct this. Please see [Video compensation](#) in the 'Installation' section.

Dual user arbitration

When using two sets of X-USBPRO modules to allow two users to access a single computer, be aware that arbitration between the users is handled by the USB sub-system of the computer. Unlike with other Adder products, this means that both users can control the computer at exactly the same time and the resulting keyboard and mouse influences will be an amalgam of the two inputs - i.e. a mouse move to the right by one user will cancel out a simultaneous left mouse move by the other. The same is also true when the local module has feed-through peripherals attached to it, adjacent to the computer.

For this reason, the X-USBPRO dual user arrangement is better suited to situations where two users would not often require simultaneous access.

Peripheral operation

USB

Each X-USBPRO remote module provides four USB outlets, each of which can support USB 2.0 peripherals at speeds up to 12Mbps. The X-USBPRO appears to the computer as a four port USB hub.

If the link between the modules is interrupted, any connected USB peripherals will be automatically disabled and re-enabled once the connection is restored.

[MS2 variant only] Note: When connecting four USB devices to the unit, ensure that their total power requirements do not exceed 1700mA (1.7A). The USB standard states a maximum allowable current draw of 500mA (0.5A) per device, although most devices remain well below this limit - USB keyboards and mice typically require 100mA. Each X-USBPRO contains a self-resetting fuse that will prevent damage by shutting down the unit if the total power draw becomes excessive.

CONTENTS

WELCOME

INSTALLATION

OPERATION

FURTHER INFORMATION

Further information



Getting assistance

If you are still experiencing problems after checking the information contained within this guide, then we provide a number of other solutions:

- **Online solutions and updates** – www.adder.com/support
Check the Support section of the adder.com website for the latest solutions and firmware updates.
- **Adder Forum** – forum.adder.com
Use our forum to access FAQs and discussions.
- **Technical support** – www.adder.com/contact-support-form
For technical support, use the contact form in the Support section of the adder.com website - your regional office will then get in contact with you.

Troubleshooting

Status indicators

The green indicators built into the link connectors on each module provide useful feedback regarding the connection and power status:

During startup (of the local module)

- One very short green flash: no valid DDC information available from a locally connected video display, no changes made to stored DDC information.
- Single green flash: DDC information being read from a locally connected video display, but no changes made to stored DDC information.
- Rapid green flash for 2 to 3 seconds, followed by single flash: New DDC information being read and stored from a locally connected video display.
- Two green flashes - Checksum error prior to copying - no information will be programmed.
- Three green flashes - Too much data to fit into the module - the module can hold a maximum of two pages of DDC information.
- Rapid green flashing followed by four flashes - data was lost during copying - the default data was substituted. Repeat the power on process.
- Rapid green flashing followed by five flashes - Checksum error during copying - the default data was substituted. Repeat the power on process.

During operation (of either the local or remote module)

- Continual yellow: Valid CATx link to other module sensed (on MS2 variants, only the indicator of the **lower** link connector is used for this purpose).
- Continual green: Correct power input sensed.

Important

The X-USBPRO can be used with other USB hubs in the system, but please note that due to power constraints, the local unit should not be connected to the downstream port of a bus-powered USB hub. Additionally, X-USBPRO-MS2 local units must always be powered using their supplied power adapter. Please see page 8 for details.

CONTENTS

WELCOME

INSTALLATION

OPERATION

FURTHER INFORMATION

Warranty

Adder Technology Ltd warrants that this product shall be free from defects in workmanship and materials for a period of two years from the date of original purchase. If the product should fail to operate correctly in normal use during the warranty period, Adder will replace or repair it free of charge. No liability can be accepted for damage due to misuse or circumstances outside Adder's control. Also Adder will not be responsible for any loss, damage or injury arising directly or indirectly from the use of this product. Adder's total liability under the terms of this warranty shall in all circumstances be limited to the replacement value of this product.

If any difficulty is experienced in the installation or use of this product that you are unable to resolve, please contact your supplier.

Safety information

- For use in dry, oil free indoor environments only.
- Do not use to link between buildings.
- Ensure that all twisted pair interconnect cables are installed in compliance with all applicable wiring regulations.
- Do not connect CATx link interfaces (RJ45 style connectors) to any other equipment, particularly network or telecommunications equipment.
- Warning – the power adapter contains live parts.
- No user serviceable parts are contained within the power adapter - do not dismantle.
- Plug the power adapter into an earthed socket outlet close to the module that it is powering.
- Replace the power adapter with a manufacturer approved type only.
- Do not use the power adapter if the power adapter case becomes damaged, cracked or broken or if you suspect that it is not operating properly.
- If you use a power extension cord with the remote module, make sure the total ampere rating of the devices plugged into the extension cord do not exceed the cord's ampere rating. Also, make sure that the total ampere rating of all the devices plugged into the wall outlet does not exceed the wall outlet's ampere rating.
- Do not attempt to service the modules yourself.
- The power supply can get warm in operation – do not situate it in an enclosed space without any ventilation.



CONTENTS

WELCOME

INSTALLATION

OPERATION

FURTHER
INFORMATION

Radio Frequency Energy

A Category 5 (or better) shielded twisted pair cable must be used to connect the units in order to maintain compliance with radio frequency energy emission regulations and ensure a suitably high level of immunity to electromagnetic disturbances.

All other interface cables used with this equipment must be shielded in order to maintain compliance with radio frequency energy emission regulations and ensure a suitably high level of immunity to electromagnetic disturbances.

European EMC directive 2004/108/EC



This equipment has been tested and found to comply with the limits for a class A computing device in accordance with the specifications in the European standard EN55022. These limits are designed to provide reasonable protection against harmful interference. This equipment generates, uses and

can radiate radio frequency energy and if not installed and used in accordance with the instructions may cause harmful interference to radio or television reception. However, there is no guarantee that harmful interference will not occur in a particular installation. If this equipment does cause interference to radio or television reception, which can be determined by turning the equipment on and off, the user is encouraged to correct the interference with one or more of the following measures: (a) Reorient or relocate the receiving antenna. (b) Increase the separation between the equipment and the receiver. (c) Connect the equipment to an outlet on a circuit different from that to which the receiver is connected. (d) Consult the supplier or an experienced radio/TV technician for help.

FCC Compliance Statement (United States)

This equipment generates, uses and can radiate radio frequency energy and if not installed and used properly, that is, in strict accordance with the manufacturer's instructions, may cause interference to radio communication. It has been tested and found to comply with the limits for a class A computing device in accordance with the specifications in Subpart J of part 15 of FCC rules, which are designed to provide reasonable protection against such interference when the equipment is operated in a commercial environment. Operation of this equipment in a residential area may cause interference, in which case the user at his own expense will be required to take whatever measures may be necessary to correct the interference. Changes or modifications not expressly approved by the manufacturer could void the user's authority to operate the equipment.

Canadian Department of Communications RFI statement

This equipment does not exceed the class A limits for radio noise emissions from digital apparatus set out in the radio interference regulations of the Canadian Department of Communications.

Le présent appareil numérique n'émet pas de bruits radioélectriques dépassant les limites applicables aux appareils numériques de la classe A prescrites dans le règlement sur le brouillage radioélectriques publié par le ministère des Communications du Canada.



CONTENTS

WELCOME

INSTALLATION

OPERATION

FURTHER INFORMATION

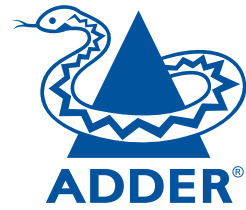

Web: www.adder.com

Contact: www.adder.com/contact-details

Support: forum.adder.com

CONTENTS

WELCOME

INSTALLATION

OPERATION

FURTHER
INFORMATION