

Omega™ 4K/UHD Wallplate Transmitter for HDMI with HDBaseT Output and USB

AT-OME-EX-TX-WP-E

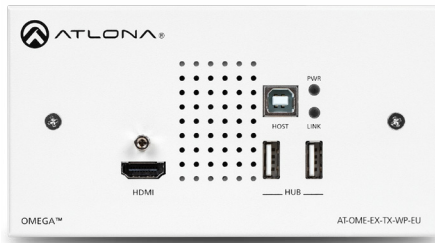

The Atlona **AT-OME-EX-TX-WP-E** is an HDBaseT transmitter for video up to 4K/60 4:2:0, plus embedded audio, control, and USB over distances up to 330 feet (100 meters). It is designed for commercial installations in Europe, and includes interchangeable EU and UK faceplates and brackets. Part of the Omega™ Series of integration products for modern AV communications and collaboration, the OME-EX-TX-WP-E is HDCP 2.2 compliant and transmits RS-232 control signals. With a matching HDBaseT receiver, the integrated USB extension addresses the challenge of connecting between USB devices at remote locations, and is ideal for software video conferencing and touch or interactive displays. The OME-EX-TX-WP-E includes a USB 2.0 host interface for a PC, plus two peripheral devices such as a speakerphone, microphone, or keyboard and mouse. This transmitter is ideal for use with Omega Series receivers as well as switchers with HDBaseT inputs.

Package Contents

- 1 x AT-OME-EX-TX-WP-E
- 1 x White EU wallplate
- 1 x White UK wallplate
- 1 x 3-pin captive screw connector
- 1 x Installation Guide



IMPORTANT: Visit <http://www.atlona.com/product/AT-OME-EX-TX-WP-E> for the latest firmware updates and User Manual.

* The AT-OME-EX-TX-WP-E is not compatible with the AT-UHD-HDVS-300 system for extending USB.

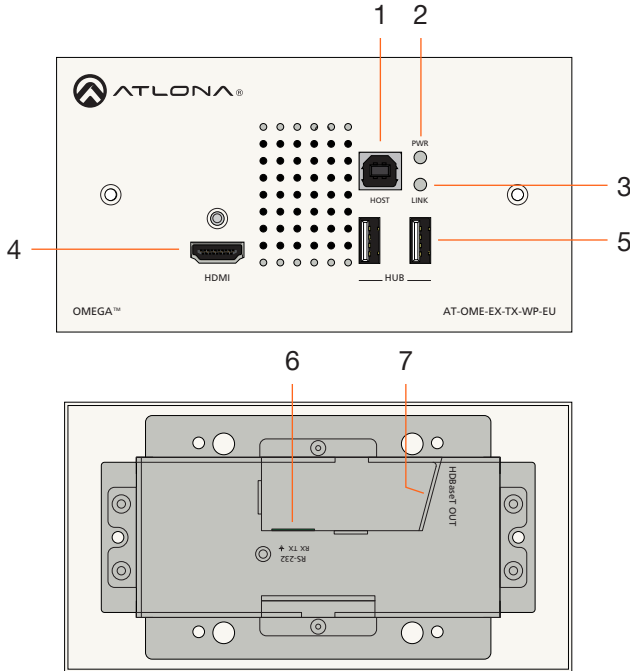

NOTE: Note that the AT-OME-EX-TX-WP-EU and AT-OME-EX-TX-WP-UK are functionally identical, except for the size of the wallplate. The AT-OME-EX-TX-WP-EU is shown above.

- | | |
|--|---|
| <p>1 HOST
Connect a USB cable from the computer to this port.</p> <p>2 PWR
This LED indicator glows solid green when the unit is powered. Refer to LED Indicators (page 7) for more information.</p> <p>3 LINK
This LED indicator glows solid amber to indicate that the HDBaseT signal integrity is good. Refer to LED Indicators (page 7) for more information.</p> <p>4 HDMI
Connect an HDMI cable from this port to a UHD/HD source.</p> | <p>5 HUB
Connect up to two USB devices, such as a speakerphone and keyboard, to these ports.</p> <p>6 RS-232
Connect an RS-232 control system to this port. Connect the included 3-pin captive screw block to this receptacle. Refer to RS-232 (page 3) for more information.</p> <p>7 HDBaseT OUT
Connect a category cable from this port to the HDBaseT IN port of the AT-OME-EX-RX or other PoE-compatible receiver.</p> |
|--|---|

RS-232

The AT-OME-EX-TX-WP-E provides an **RS-232** port which allows communication between a control system and an RS-232 device. This step is optional.

1. Use wire strippers to remove a portion of the RS-232 cable jacket.
2. Remove at least 3/16" (5 mm) from the insulation of the RX, TX, and GND wires.
3. Insert the TX, RX, and GND wires into correct terminal using the included 3-pin captive screw connector.
4. Connect the opposite end of the cable to the control system.

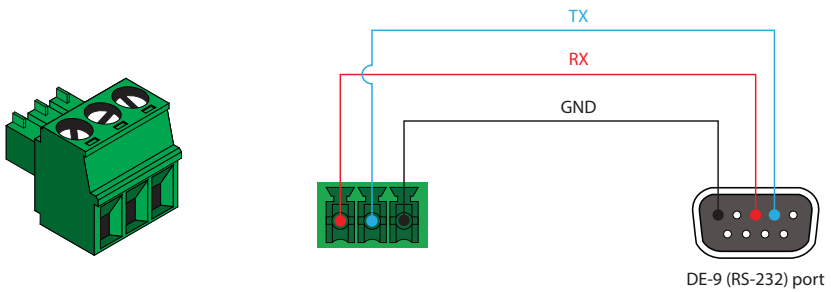

NOTE: Typical DE-9 connectors use pin 2 for TX, pin 3 for RX, and pin 5 for ground. On some devices functions of pins 2 and 3 are reversed.

RS-232 port on back of unit

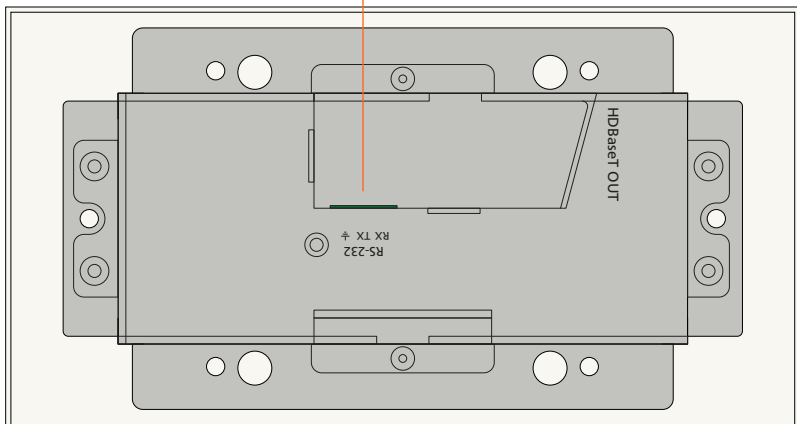

Faceplate Removal and Assembly

Removal of the faceplate requires that the AT-OME-EX-TX-WP-E be disassembled from the electrical box or mud ring. A small Phillips-head screwdriver is required to remove the faceplate.

1. Unscrew both Phillips-head screws and the HDMI connector hex bolt from the front of the faceplate, as shown:
2. Gently remove the faceplate by pulling it toward you.

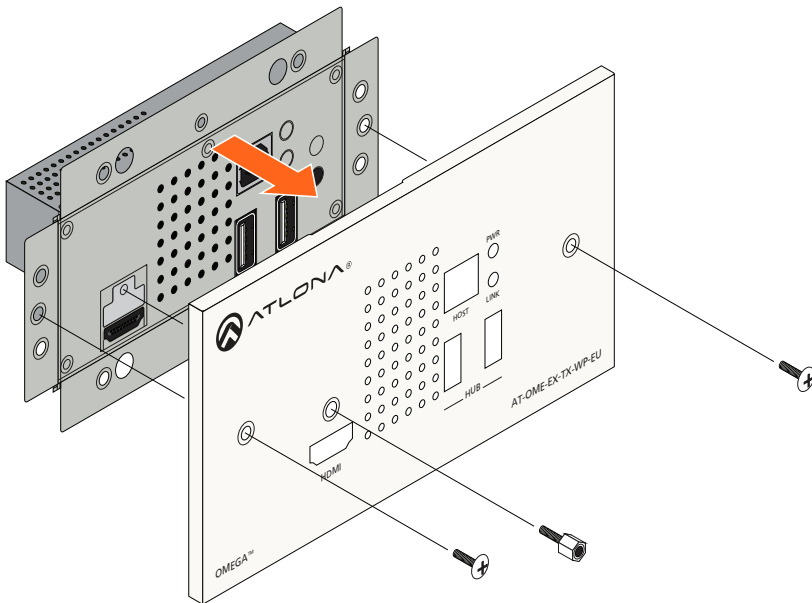

NOTE: It is not required that the AT-OME-EX-TX-WP-E be removed from the electrical box or mud ring before removing the wallplate.



Installation

1. Connect a UHD/HD source to the **HDMI** port.
2. OPTIONAL: Connect a USB cable from the host computer to the **HOST** port.
3. OPTIONAL: Connect up to two USB devices, such as a speakerphone or keyboard to the **HUB** ports.
4. Connect a category cable, from the **HDBaseT OUT** port on the rear of the transmitter, to the **HDBaseT IN** port on the receiver.
5. OPTIONAL: Connect an RS-232 cable between a control system and the **RS-232** port on the transmitter. Refer to **RS-232 (page 3)** for more information.

Cable Recommendation Guidelines

Refer to the tables below for recommended cabling when using Atlona products with HDBaseT. The green bars indicate the signal quality when using each type of cable. Higher-quality signals are represented by more bars.

Core	Shielding	CAT5e	CAT6	CAT6a	CAT7
Solid	UTP (unshielded)	■	■■■	■■■■	N/A
	STP (shielded)	■■	■■■■	■■■■■	■■■■■



IMPORTANT: Stranded or patch cables are not recommended due to performance issues.

Cable*	Max. Distance @ 4K	Max. Distance @ 1080p
CAT5e	295 feet (90 meters)	330 feet (100 meters)
CAT6 / CAT6a / CAT7	330 feet (100 meters)	330 feet (100 meters)

*Atlona recommends TIA/EIA 568-B termination for optimal performance.

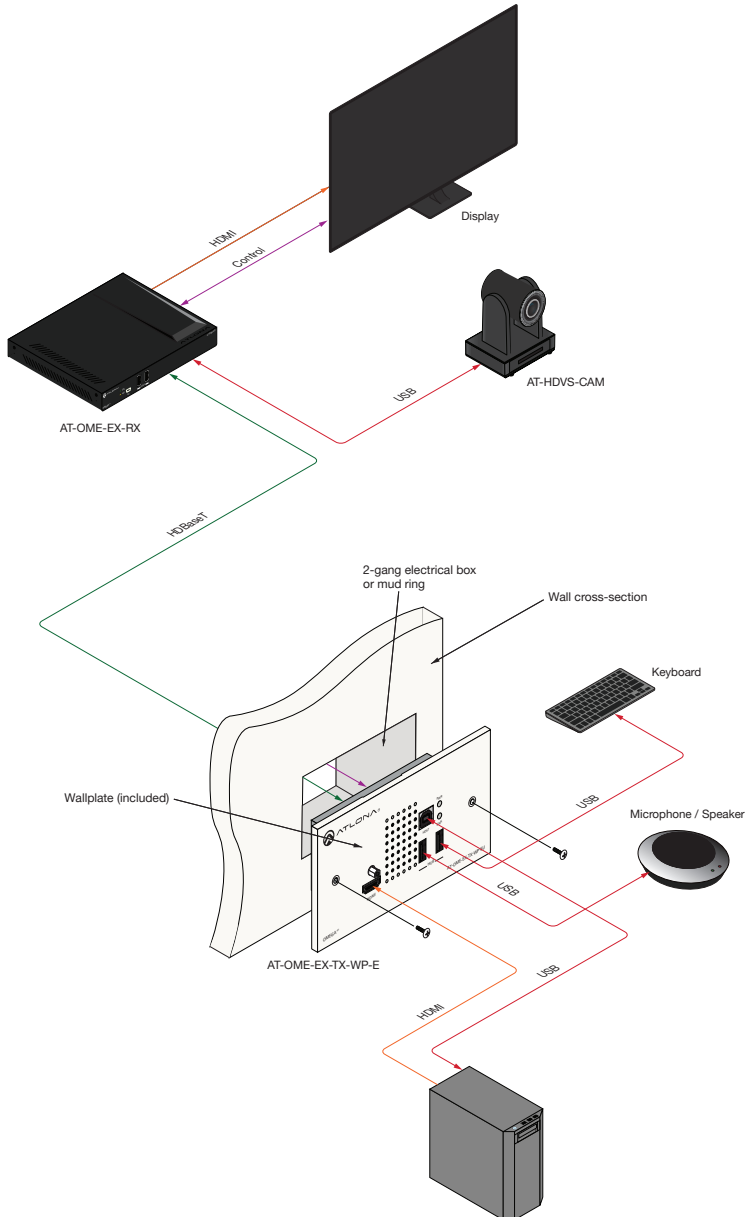

Connection Diagram







LED Indicators

The **PWR** and **LINK** LED indicator on both the transmitter and receiver unit provides basic information on the current status of the AT-OME-EX-TX-WP-E.

PWR		Description
Solid green		Unit is powered. Normal operating mode.
Blinking green		Unit is in firmware update mode. Refer to Updating the Firmware (page 8) for more information.
Off		Unit is not powered. <ul style="list-style-type: none"> Make sure that the category cable between the HDBaseT IN port on the transmitter and the HDBaseT OUT port on the receiver is secure. Make sure that the power supply, at the receiver, is connected to an active AC outlet.

LINK		Description
Solid amber		The link integrity between the transmitter and the receiver is good.
Blinking amber		Poor signal integrity between the transmitter and the receiver. <ul style="list-style-type: none"> Make sure that the category cable between the HDBaseT IN port on the transmitter and the HDBaseT OUT port on the receiver is secure. The category cable may be compromised. Try using a different category cable. Make sure that the cable is solid core. Stranded or patch cables are not recommended.
Off		The link integrity between the transmitter and the receiver is compromised. <ul style="list-style-type: none"> Check the category cable between the HDBaseT IN port on the transmitter and the HDBaseT OUT port on the receiver.

Updating the Firmware

Requirements:

- AT-OME-EX-TX-WP-E
- Firmware file
- Computer running Windows
- USB-A to USB-B cable

1. Disconnect power from the AT-OME-EX-TX-WP-E, which can be done by disconnecting the category cable from the HDBaseT port on the receiver.
2. Remove the faceplate to expose the hidden “firmware update” button, located next to the USB **HUB** ports, as shown. Refer to [Faceplate Removal and Assembly \(page 4\)](#) for more information.

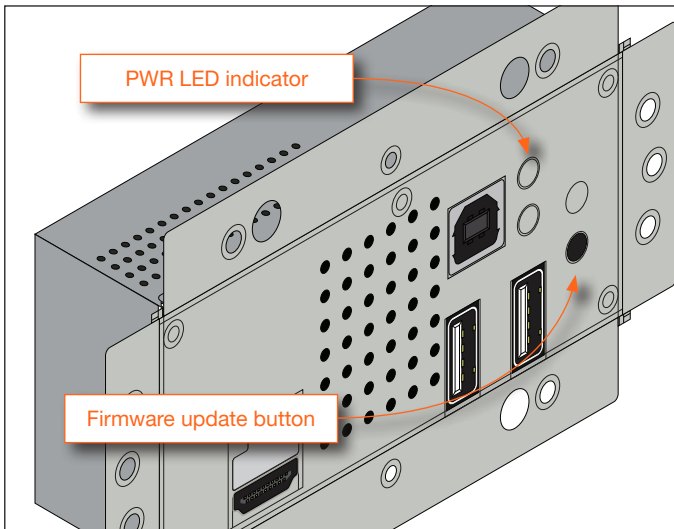

3. Connect a USB cable from the **HOST** port on the AT-OME-EX-TX-WP-E to a PC, using a USB-A to USB-B cable.
4. Simultaneously press and hold the firmware update button, while reconnecting the power. The **PWR** LED indicator will be blinking green.



IMPORTANT: Do not disconnect power from unit during the firmware update process. Doing so may damage the unit.

5. The USB UPDATE folder will be displayed. If this folder is not displayed, automatically, select the USB UPDATE drive from Windows Explorer.

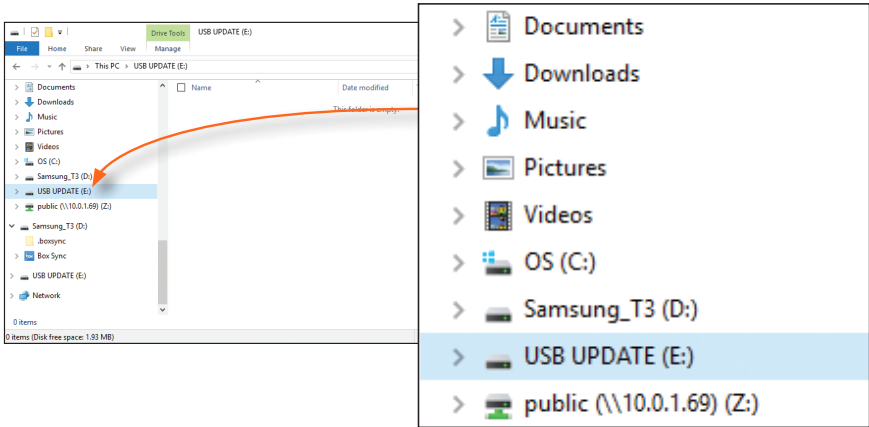

6. Drag and drop the firmware file into the USB drive folder.
7. After the firmware file has been placed in the folder, the firmware update process will begin. During the update process, the **PWR** LED indicator will flash green.
8. Once the update process is complete, the AT-OME-EX-TX-WP-E will automatically reboot.
9. Once the **PWR** LED returns to solid green, the firmware update process is complete. The firmware update process takes approximately 10 to 15 seconds to complete.



Notes



Notes



Toll free US International
atlona.com • 877.536.3976 • 41.43.508.4321