

Extend | Switch | Matrix | Remote | **Secure**

# Secure

High Performance  
Secure KVM

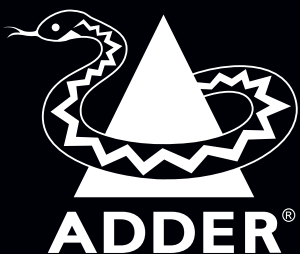

# What is KVM?

KVM (keyboard, video, mouse) switch technology was first introduced in the 1990's as a method of controlling multiple computers with a single keyboard, video and mouse. A few years later, KVM extenders were introduced to enable the relocation of critical computing hardware away from the user environment to a secure server room. The principle of KVM remains unchanged to this day, but with customers seeking ever increasing flexibility and instant access to data, Adder leads the way in the development of KVM around the world.

# What is Secure KVM?

The quantity of data in control room environments is growing exponentially and so is the risk of hacking and cyber-attacks. To minimize this risk, and ready themselves for the next generation of operational challenges, organizations must invest in the right technology to facilitate growth while protecting against malicious activity, data leakage and security breaches.

The introduction of technologies and systems that are compliant with industry regulations, but that also allow for an improved user experience, plays a significant part in how businesses can transform their working environments.

Secure KVM allows operators in high-pressure environments, such as command and control rooms, to remotely access critical computing resources in real-time, without compromising network security. For the IT manager, secure KVM delivers improved levels of flexibility and interoperability with the reassurance that the network is secured. By optimizing workflows and implementing secure KVM technology that facilitates sharing and collaboration, working environments can be made more dynamic and secure.

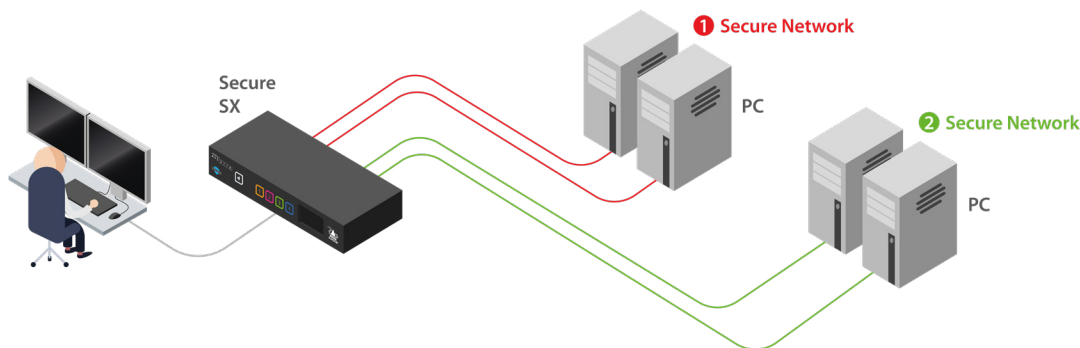

Fig. 1: A secure KVM switch enables the user to switch between computers in secure networks with different classification levels.

## Protection Profiles for Secure KVM

A Protection Profile (PP) states a security problem rigorously for a given collection of systems or products, and specifies security requirements to address that problem without dictating however the requirements will be implemented. A PP may inherit requirements from one or more other PPs. For a product to be evaluated and certified according to Common Criteria (CC), the product vendor should comply with one or more PPs. The National Information Assurance Partnership (NIAP) is an organization that sets the international standardized process for information technology security evaluation, validation and certification. In order to comply with the latest protection profile security requirements, peripheral sharing devices (PSD) vendors need to design and manufacture their products as entirely secure.

In 2019, NIAP announced protection profile 4.0 which is used to identify threats and corresponding security measures for PSD's including KVM switches. Over the past four years, NIAP has been refining the new PP 4.0 to include a host of technical and structural changes that ensure IT products, particularly PSD's, continue to conform for use in national security systems.





# ADDERView™ Secure Range

When instant access is vital and security is critical

Secure environments demand the highest levels of security, data accuracy and reliability, so when investing in a secure KVM solution, NIAP compliance should be an essential consideration. With Adder's NIAP PP 4.0 compliant range of secure KVM solutions, users can simultaneously control and access classified and non-classified network sources in real-time; all while benefitting from pixel-perfect data visualization at resolutions up to UHD 4K at 60 frames per second.

The ADDERView Secure range maintains channel separation while improving desktop ergonomics and switching time to improve situational awareness, enhance real-time data visualization and optimize secure collaboration in mission-critical environments.



## Reasons to Choose Secure

- ✓ Declutter the desktop environment and improve ergonomics
- ✓ Achieve a secure real-time, at-the-PC user experience
- ✓ Access multiple classified and non-classified sources from one screen
- ✓ Instantly visualize status information

# ADDERView Secure KVM

## In Focus



### Enhanced Security

With a NIAP Protection Profile 4.0 compliant design, Adder's range of secure KVM solutions feature tamper-proof cases, hardware-based port isolation and non-upgradeable firmware to ensure absolute security. Uni-directional data paths ensure video, audio and USB signals travel in one direction only, while EDID emulation and MCCS blocking are deployed to prevent potential data leakage through the attached display.

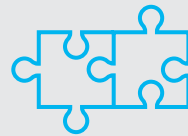

### Ultimate Compatibility

The ADDERView Secure range is designed to fit seamlessly into an existing network, removing the need to use interface converters. The range of secure switches supports both single and dual-head configurations at video resolutions up to UHD 4K. For users requiring additional functionality, the ADDERView Secure Flexi-Switch and ADDERView Secure Multi-Viewer allow the user to connect to a combination of single and dual-head PCs simultaneously. Secure switches are available with support for DisplayPort™, HDMI, DVI, VGA and USB interfaces.



### Instant Authentication

In many secure applications, access to critical computing equipment is locked down to approved users. The ADDER Secure Card Reader allows a user to simultaneously connect to up to four host computers meaning there is no need to re-authenticate at the point of switching. To ensure security is not compromised, the user is automatically logged off from all computers when the smart card is removed.



### Fast Switching

Fast switching between channels is a fundamental requirement for all KVM switches. Emulated USB technology ensures fast and reliable USB switching between devices meaning that users can seamlessly switch between computers using a mouse, selection of keyboard hotkeys, front panel or Remote Control Unit. Users can switch computers by simply moving the mouse across the screen border – allowing for instant situational awareness.



## Connectivity

Organizations with command and control rooms commonly require flexible and adaptable IT infrastructure that can change to fit the current operation or situation. ADDERView Secure KVM switches are configured with DVI or DualPorts, for DisplayPort/HDMI, to suit different IT configurations. The DVI switches support video resolutions up to 2560x1600 at 60 frames per second (fps) while the DualPort supports DisplayPort and HDMI resolutions up to UHD 4K at 60 fps. Both switches support single or dual-heads and can connect to computers running Windows, Unix, Linux or Mac OS.



## Ease of Use

The ADDERView Secure range has been created with enhanced usability and desktop ergonomics in mind. Where the application allows, the secure range uses instant switching technology to ensure that switching between ports is as simple as moving the mouse between windows - ensuring users can quickly respond in high pressure situations. The front panel of Adder secure switches incorporates keyboard LEDs – helping to avoid typing errors as the keyboard status LEDs are disabled by the uni-directional data path. And the ADDER Remote Control Unit (RCU) allows operators to access their secure devices when stored under the desk or in a remote server room.

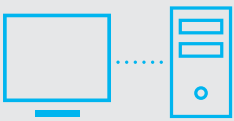

## Command & Control Applications

While many switches can be directly connected to managed computers, there are applications that have more complex requirements. In a command and control center, secure KVM switches are ideally suited to manage multiple classified and unclassified computers located in separate server rooms. Combining the ADDERView Secure range with Adder's extension or matrix solutions at each console delivers a flexible and secure solution to access all required computers.

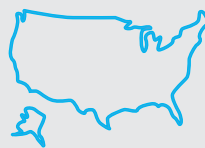

## Made in America

Designed to meet the strict specifications of the US government, and comply with the latest NIAP Protection Profile 4.0, the ADDERView Secure range is TAA compliant and made in America.



## Explore the Range

### ADDERView Secure Desktop KVM Switches

In order to build and maintain an environment that is conducive to making mission-critical decisions, it is essential that organizations consider desktop ergonomics and user experience. When designing installations with as few peripherals as possible, secure KVM switches deliver user-friendly and ergonomically optimized workspaces for operators in high pressure environments.

ADDERView Secure Desktop KVM Switches are designed to improve usability - with an intuitive E-Paper display to show real-time status information and color-configurable LEDs to reduce the risk of user error. Adding the ADDER Remote Control Unit (RCU), users can mount secure switches in a separate rack or under the desk to minimize equipment at the workstation.

Adder Secure KVM switches also provide redundancy by enabling the user to switch to a different source PC. ADDERView Secure switches have an audio hold function so users can listen to the audio channel from one computer whilst accessing and controlling another.



#### Switch

Perfect for users needing to access one computer at a time.

### ADDERView Secure Flexi-Switch

Flexibility often comes at the price of usability but the ADDERView Secure Flexi-Switch has been designed to support the user when operating in mission-critical environments. The secure Flexi-Switch allows customers to standardize on a single model switch but service multiple configurations. By supporting a customer's changing environment, IT managers can protect their initial IT investment without needing to rip and replace existing equipment. For applications that require more flexibility than a standard 4-port KVM switch can

provide, the secure Flexi-Switch has eight input computer ports which can be connected to a combination of single and dual-head computers - giving the user real-time control of up to two computers simultaneously.

With dual DisplayPort input and output ports, and support for all video resolutions up to UHD 4K at 60 fps on dual-heads, the solution is well-placed to serve operations across all industries requiring secure KVM.



#### Switch and Free-Flow

Simultaneous control of two computers when speed is critical.



## ADDERView Secure Multi-Viewer

When operating a standard KVM switch, operators need external knowledge to understand which computer to switch to. This is acceptable when carrying out prescribed tasks but unsatisfactory when the operator must immediately respond to real-time, and often critical, events. In these situations, the secure Multi-Viewer allows an operator to monitor and interact with up to four computers simultaneously – instantly taking control of the PC by moving the mouse cursor between windows.

With in-built pre-defined and custom preset display modes, the secure Multi-Viewer allows the operator to move and resize windows to create their own personal layout. And the ultra-clear 4K output means they can interact with multiple input computers without losing quality. The secure Multi-Viewer supports up to two monitors - with a second monitor used to duplicate or extend the primary display. When running an extended display, operators can simultaneously monitor all tiled inputs on one monitor whilst interacting with a target PC in full-screen mode on the other.



### Switch, Free-Flow and Multi-View

Improve situational awareness in control rooms by giving simultaneous access to up to four computers from a single workstation.



### ADDER Secure Remote Control Unit

The ADDER Secure Remote Control Unit, compatible with all switches in the ADDERView Secure range, allows operators to control secure KVM devices when mounted under the desk, or in a server rack. The compact unit provides secure push button access to any channel directly from the user desktop.



### ADDER Secure Card Reader

The ADDER Secure Card Reader allows users to stay logged-in on a CAC designated network whilst seamlessly switching between other networks. In time-critical situations, the secure Card Reader allows simultaneous authentication with up to four isolated computers - without the need to re-authenticate at the point of switching.



### ADDER Secure Port Expander

The ADDER Secure Port Expander can be used to provide an additional port for USB HID devices. It only allows secure, uni-directional connection of USB HID devices.

# Expanding Beyond the Switch

When identifying the needs of secure KVM users, Adder recognizes that the user experience is a primary area for innovation. The ADDERView Secure range simplifies and enhances interaction between the user and critical computers. When designing workspaces, desktop ergonomics should be a main focus, and KVM has a key role to play.

For many years, Adder has been a global leader in the design and manufacture of KVM extension and matrix solutions that have enabled customers to back rack computers in secured and environmentally controlled server rooms. By relocating computers, customers can prevent physical access to the computer and network, save space by reducing the volume of hardware at the desktop, eliminate noise and heat generated by computers and extend the lifecycle of computer hardware.

Solutions such as the ADDERLink™ XDIP, ADDERView DDX and ADDERLink INFINITY can be combined with ADDERView Secure switches to improve both user desktop ergonomics and security.

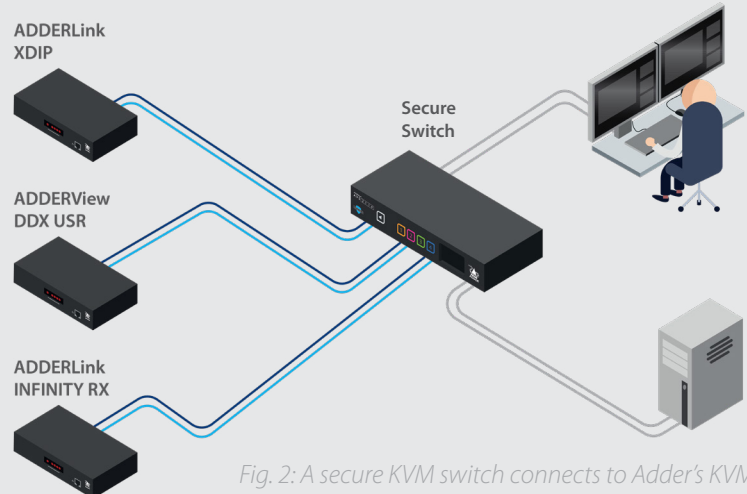

Fig. 2: A secure KVM switch connects to Adder's KVM extension and matrix products to increase flexibility and security.

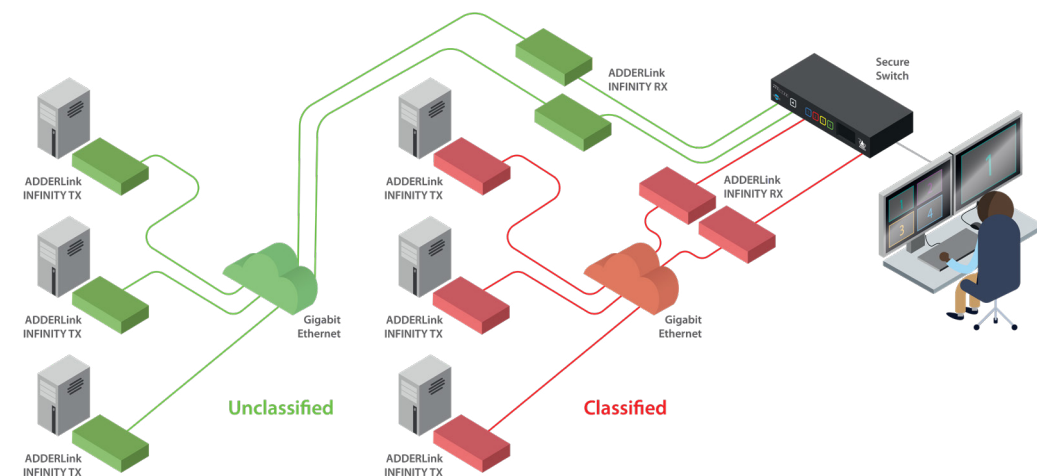

Fig. 3: When combined with an Adder matrix, a secure KVM switch provides the user with instant switching between larger groups of computers while retaining isolation. When accessing different security networks, an air gap must be maintained.

By combining ADDERView Secure switches with an IP KVM matrix solution, organizations can securely expand their access to large pools of computers. Instant switching and signal extension create a more flexible workspace in locations such as offices, meeting rooms, control rooms and operations centers.

While many organizations are focused on security, they must also consider the operational changes forced upon them by demand growth, innovation and regulation. Roles, teams and technology can all change quickly as businesses seek efficiency under ever-changing circumstances.

IP KVM matrix solutions address these challenges by connecting large groups of people to key information. They enable collaborative working by connecting 24/7/365 dynamic workspaces.

## Examples include:

- Critical control rooms with operators, supervisors and senior officials.
- Crisis rooms where situational awareness is key.
- Meeting spaces that require live information for optimal decision making.
- Associated training and simulation facilities



# A Solution for All Industries

## Government and Military

The quantity of sensitive data required by the military is growing exponentially, and secure environments such as military control rooms demand heightened levels of security, accuracy and reliability. Modern military demands that sensitive data can be shared across networks and even country borders which can lead to a plethora of cybersecurity risks.

Secure KVM solutions from Adder have been designed to support teams whether situated on the battlefield, in a military aircraft or on a navy vessel. With a NIAP PP 4.0 compliant design, and support for UHD 4K at 60 fps video resolutions, the ADDERView Secure range is an ideal solution to improve IT agility and data collaboration in mission-critical scenarios.



## Medical

Medical staff need real-time access to highly sensitive patient or pharmaceutical data in order to deliver exceptional levels of care. Clinicians must be able to access a corporate network and the plethora of systems used to communicate and collaborate with specialists across a global network.

Secure KVM technology allows monitoring and computing equipment to be extended away from the ward or treatment room while still giving medical staff instant access to the data they need to administer care. Adder's range of secure KVM switches delivers fast and seamless access to multiple computers – regardless of whether the target PC contains confidential data or access to the corporate network. UHD 4K video resolutions ensure pixel perfect image quality which means there is no loss of resolution when reviewing patient scans or images.



## Post-Production

As demand for original content continues to rise, and large entertainment providers base their success on the latest blockbuster, there is growing pressure on post-production houses to streamline workflows to speed up content delivery; without sacrificing the quality of content or cybersecurity. In the dynamic environment that is a post-production suite, the ADDERView Secure range brings improved usability, desktop ergonomics and flexibility along with the additional benefit of security. Combined with support for UHD 4K resolutions, the range allows media professionals to maximize their output while remaining "compliant" with studio security expectations.



# ADDERView AVS 2114 & 2214

## Desktop KVM Switches

Secure KVM switch for sharing **single (AVS 2114) or dual-head (AVS 2214) DVI** video, USB keyboard and mouse, plus analog audio between four computers spanning multiple security classification levels.

### Video resolutions

The system supports input resolutions up to HD (1920 x 1200).

### Software compatibility

Windows, Linux, Mac host computer OS's  
USB HID, including touchscreens compliant with Microsoft Digitizer.

### Console connections

- DVI-D, USB type A, Audio 3.5mm
- RJ12 for remote control

### Computer connections

#### Single-head (AVS-2114 only)

- 4x DVI-D, USB type B, Audio 3.5mm

#### Dual-head (AVS-2214 only)

- 8x DVI-D USB type B, Audio 3.5mm

### Front Panel

- Audio hold button and status LED
- 4x Channel selection button and status LED
- 212x104 E-paper status display

### Power supply

- 100-240V AC, 47/63Hz
- 12V DC 18W output from power supply unit

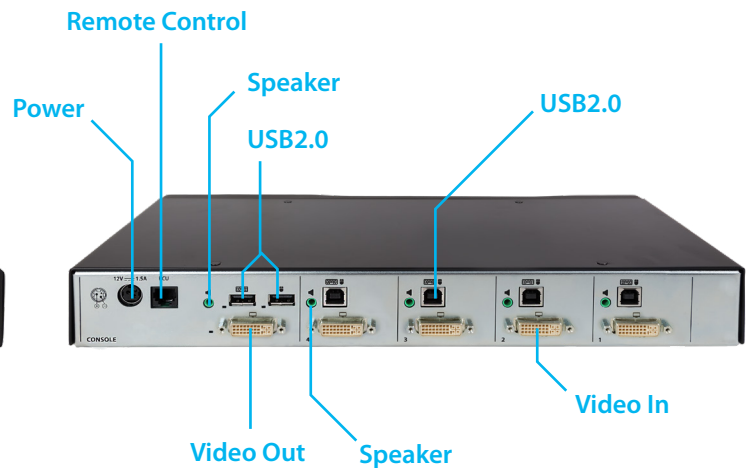

### Physical design

- Robust metal construction

#### Single-head (AVS 2114)

- 13.54"/344mm(w), 1.73"/44mm(h), 6.73"/171mm(d)
- 1.6kg/3.53lbs

#### Dual-head (AVS 2214)

- 13.54"/344mm(w), 2.4"/61mm(h), 6.5"/165mm(d)
- 2.0kg/4.41lbs

### Environmental

- Operating temp: 32°F to 104°F (0°C to 40°C)
- Storage temp: -4°F to 140°F (-20°C to 60°C)
- Humidity: 0-80% RH, non-condensing

### Approvals

- CE, FCC class A, TUV US & Canada
- NIAP PP 4.0 Compliant Design for Peripheral Sharing Devices (PSD)

# ADDERView AVS 4114 & 4214

## Desktop KVM Switches

Secure KVM switch for sharing **single (AVS 4114) or dual head (AVS 4214) 4K** video, USB keyboard and mouse, plus analog audio between four computers spanning multiple security classification levels.

### Video resolutions

The system supports UHD 4K resolutions to a maximum of 3840 x 2160 @ 60Hz.

### Software compatibility

Windows, Linux, Mac host computer OS's  
USB HID, including touchscreens compliant with Microsoft Digitizer.

### Console connections

- Dual port for DP/HDMI, USB type A, Audio 3.5mm
- RJ12 for remote control

### Computer connections

#### Single-head (AVS-4114 only)

- 4x dual ports for DP/HDMI, USB type B, Audio 3.5mm

#### Dual-head (AVS-4214 only)

- 8x dual ports for DP/HDMI, USB type B, Audio 3.5mm

### Front Panel

- Audio hold button and status LED
- 4x Channel selection button and status LED
- 212x104 E-paper status display

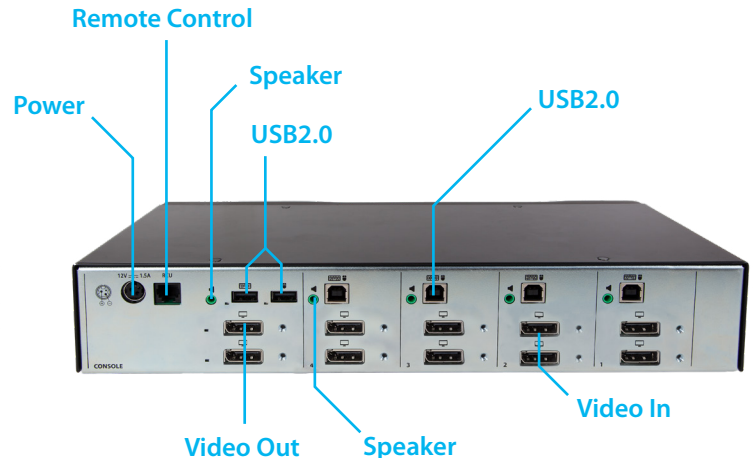

### Physical design

- Robust metal construction

#### Single-head (AVS 4114)

- 13.54"/344mm(w), 1.73"/44mm(h), 6.73"/171mm(d)
- 1.6kg/3.53lbs

#### Dual-head (AVS 4214)

- 13.54"/344mm(w), 2.4"/61mm(h), 6.5"/165mm(d)
- 2.0kg/4.41lbs

### Environmental

- Operating temp: 32°F to 104°F (0°C to 40°C)
- Storage temp: -4°F to 140°F (-20°C to 60°C)
- Humidity: 0-80% RH, non-condensing

### Approvals

- CE, FCC class A, TUV US & Canada
- NIAP PP 4.0 Compliant Design for Peripheral Sharing Devices (PSD)

# ADDERView AVS 4128

## Flexi-Switch

Secure KVM **flexi-switch** for sharing single or dual-head 4K video, USB keyboard and mouse, plus analog audio between eight computers spanning multiple security classification levels.

### Video resolutions

The system supports UHD 4K resolutions to a maximum of 3840 x 2160 @ 60Hz.

### Software compatibility

Windows, Linux, Mac host computer OS's  
USB HID, including touchscreens compliant with Microsoft Digitizer.

### Console connections

- 2x Dual port for DP/HDMI, USB type A, Audio 3.5mm
- RJ12 for remote control

### Computer connections

- 8x dual ports for DP/HDMI, USB type B, Audio 3.5mm

### Front Panel

- Monitor selection button
- Audio hold button and status LED
- 8x Channel selection button and status LED
- 212x104 E-paper for status display

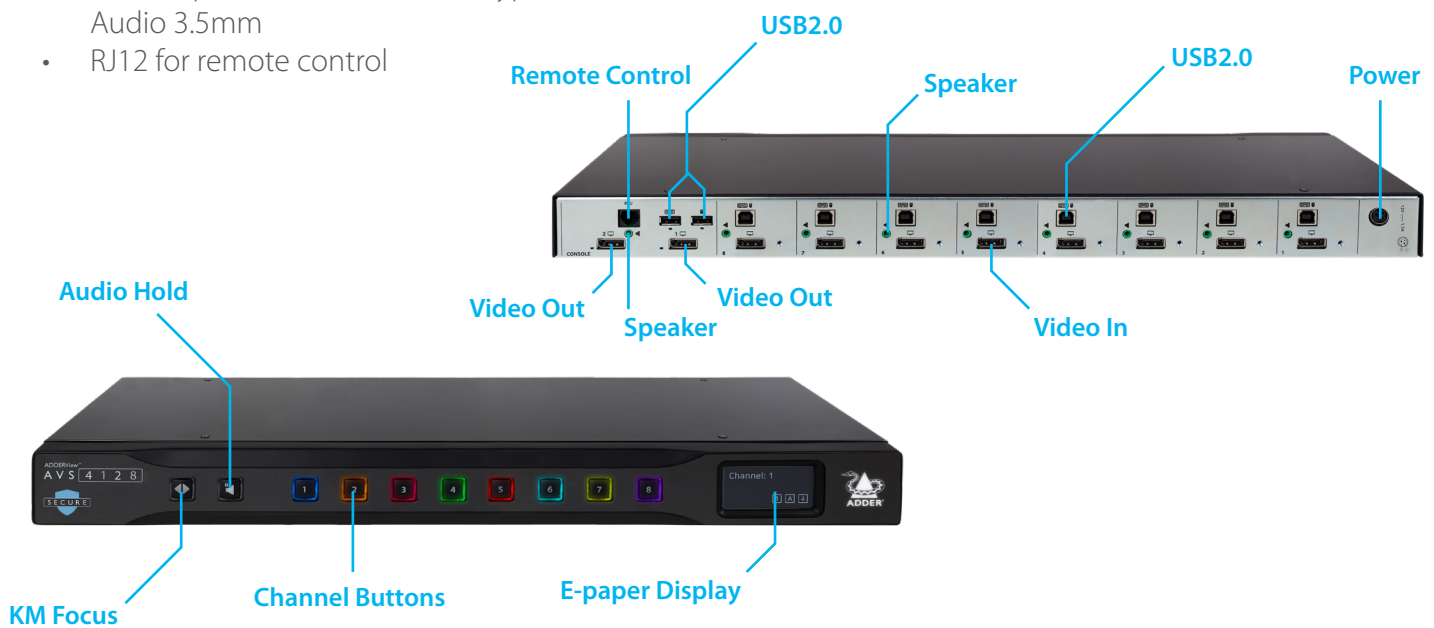

### Physical design

- Robust metal construction
- 18.9"/480mm(w), 1.85"/47mm(h), 5.98"/152mm(d)
- 2.6kg/5.73lbs

### Power supply

- 100-240V AC, 47/63Hz
- 12V DC 30W output from power supply unit

### Environmental

- Operating temp: 32°F to 104°F (0°C to 40°C)
- Storage temp: -4°F to 140°F (-20°C to 60°C)
- Humidity: 0-80% RH, non-condensing

### Approvals

- CE, FCC class A, TUV US & Canada
- NIAP PP 4.0 Compliant Design for Peripheral Sharing Devices (PSD)

# ADDERView AVS 1124

## Multi-Viewer

Secure **multi-viewer switch** for sharing KVM, plus analog audio between four computers spanning multiple security classification levels. The switch accepts HD DVI inputs and provides dual output ports for HDMI at up to 4K video resolution.

### Video resolutions

The system supports input resolutions up to HD (1920 x 1200). It generates output resolutions up to UHD 4K (3840 x 2160 @ 30Hz).

### Software compatibility

Windows, Linux, Mac host computer OS's USB HID, including touchscreens compliant with Microsoft Digitizer.

### Console connections

- 2x digital ports for HDMI, USB type A, Audio 3.5mm
- RJ12 for remote control

### Computer connections

- 4x DVI-D, USB type B, Audio 3.5mm

### Front Panel

- Audio hold button and status LED
- 4x Channel selection button and status LED
- 212x104 E-paper status display

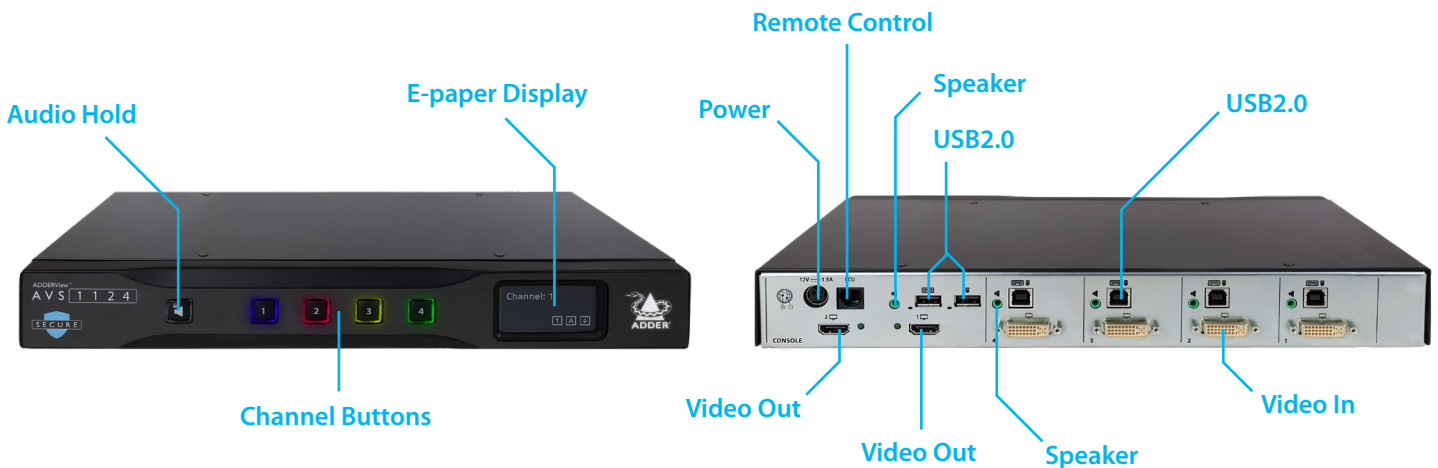

### Physical design

- Robust metal construction
- 13.54"/344mm(w), 2.32"/59mm(h), 5.98"/152mm(d)
- 1.6kg/3.53lbs

### Power supply

- 100-240V AC, 47/63Hz
- 12V DC 30W output from power supply unit

### Environmental

- Operating temp: 32°F to 104°F (0°C to 40°C)
- Storage temp: -4°F to 140°F (-20°C to 60°C)
- Humidity: 0-80% RH, non-condensing

### Approvals

- CE, FCC class A, TUV US & Canada
- NIAP PP 4.0 Compliant Design for Peripheral Sharing Devices (PSD)

# About Adder

## Global Leader

Established in 1984 by Adrian Dickens, an Engineering graduate from the prestigious University of Cambridge, Adder has become a global leader in the design and manufacture of connectivity and high performance IP KVM solutions. Adder's established and respected heritage in the market has led to the brand being trusted to meet their KVM requirements by the world's leading organizations.



## A Proven Heritage

Adder has a proven history in the innovation and manufacture of secure KVM technology and a global reputation for high quality products. Renowned for technical excellence, reliable performance and market leading specifications, Adder's secure switches are trusted by governments and organizations around the world to deliver real-time control of remote critical computing resources.

## Adder Solutions Grow Alongside Business Needs

Adder understands that businesses change and evolve over time and that technology must provide the flexibility to grow in sync with the wider organization. Adder's solutions are all designed with flexibility in mind – allowing endpoints to be added as the business grows - avoiding the need to over commit budget at the point of system design or implementation.



## A Global Focus

With an established network of 12 regional offices around the world, and a comprehensive program supporting more than 200 trusted partners, Adder is dedicated to delivering around the clock sales support and a complete 24/7 Professional Services offering.

### Global Headquarters

Tel: +44 (0)1954 780044 | Fax: +44 (0)1954 780081  
Email: sales@adder.com

### Americas

Tel: +1 888 932 3337 | Fax: +1 888 275 1117  
Email: usasales@adder.com

### Asia Pacific

Tel: +65 6288 5767 | Fax: +65 6284 1150  
Email: asiasesales@adder.com

All brand names and trademarks are the property of their respective owner. Copyright 2020 | Adder Technology Ltd. | 202003\_002\_secure\_brochure

Information contained in this data sheet is up-to-date and correct as at the date of issue. As Adder Technology cannot control or anticipate the conditions under which this product may be used, each user should review the information in the specific context of planned use. Images are for illustrative purposes only.

**ADDER®**  
THE IP KVM PEOPLE