



**INDUSTRIAL
10/100BASE-TX TO 100BASE-FX
MEDIA CONVERTERS**

KCD-300 Series

Installation Guide



(C) 2006 KTI Networks Inc. All rights reserved. No part of this documentation may be reproduced in any form or by any means or used to make any directive work (such as translation or transformation) without permission from KTI Networks Inc.

KTI Networks Inc. reserves the right to revise this documentation and to make changes in content from time to time without obligation on the part of KTI Networks Inc. to provide notification of such revision or change.

For more information, contact:

United States

KTI Networks Inc.
P.O. BOX 631008
Houston, Texas 77263-1008

Phone: 713-2663891
Fax: 713-2663893
E-mail: kti@ktinet.com
URL: <http://www.ktinet.com/>

International

Fax: 886-2-26983873
E-mail: kti@ktinet.com.tw
URL: <http://www.ktinet.com.tw/>

The information contained in this document is subject to change without prior notice. Copyright (C) All Rights Reserved.

TRADEMARKS

Ethernet is a registered trademark of Xerox Corp.

FCC NOTICE

This device complies with Class B Part 15 the FCC Rules. Operation is subject to the following two conditions: (1) This device may not cause harmful interference, and (2) this device must accept any interference received including the interference that may cause.

CE NOTICE

Marking by the symbol  indicates compliance of this equipment to the EMC directive of the European Community. Such marking is indicative that this equipment meets or exceeds the following technical standards:

EMC Class B

EN 50081-1/1992 : EN55022:1994/A1:1995/A2:1997 Class B

EN61000-3-2:2000

EN61000-3-3:1995/A1:2001

EN 55024:1998/A1:2001

IEC 61000-4-2:1995

IEC 61000-4-3:1995

IEC 61000-4-4:1995

IEC 61000-4-5:1995

IEC 61000-4-6:1996

IEC 61000-4-8:1993

IEC 61000-4-11:1994

Table of Contents

1. Introduction	5
1.1 Features	6
1.2 Specifications	7
1.3 Model Specifications	12
1.4 Special Functions	13
2. Installation	15
2.1 Unpacking	15
2.2 DIN-Rail Mounting	16
2.3 Mounting on a Panel Surface	19
2.4 Applying Power	21
2.5 Making TP Port Connection	23
2.6 Making FX Port Connection	24
3 Configuration Switches & LED Indicators	25
3.1 Configuration Switches	26
3.1.1 Forwarding Mode Setting SW5	27
3.1.2 802.3x Function Setting SW6	27
3.1.3 FX Duplex Setting SW7	28
3.1.4 Factory Default Settings	28
3.2 LED Indicators	29

1. Introduction

The industrial 10/100BASE-TX to 100BASE-FX media converter series provides industrial strength Ethernet copper-to-fiber media conversion, allowing for 10Base-T-100Base-FX or 100Base-TX-100Base-FX over multi-mode or optional single-mode fiber optical media.

In addition to the basic media conversion functions, the converters also provide some special functions to enhance the flexibility for wide application needs as follows:

- Comprehensive configuration settings to increase the flexibility for more application needs
- Smart-Forward operating mode, which uses store-and-forward mechanism for packet forwarding normally when both media ends operate at different speed, but switch to direct conversion automatically to achieve the least latency when both media ends operate at the same speed.
- Link Fault Pass Through function which allows link fault status passes through from one end to another end transparently.

For industrial environment, the converters are designed with the following enhanced features exceeding that of commercial media converters:

- High and wide operating Temperature
- Wide operating voltage range for DC power input
- Power input interface: Screw terminal block and DC jack for adapter
- DIN rail mounting support for industrial enclosure
- Screw panel mounting support for industrial enclosure
- Industrial-rated Emission and Immunity performance



1.1 Features

- Convert speed and media type
- Support full wire speed conversion
- Support 10Mbps and 100Mbps speed on TP (copper) connections
- Auto MDI/MDI-X detection function on the TP (copper) port
- Auto-negotiation function on the TP port
- Link fault pass through function
- Provide comprehensive manual configuration settings
- Transparent conversion to 802.1Q VLAN tagged packets
- Far End Fault function on FX (fiber) port
- Support wide range of fiber options on the FX port
- Low power consumption
- Two power interface type: screw terminal block and DC jack
- Wide operating voltage input range : +7 ~ 30VDC
- Support DIN rail mounting
- Support panel mounting
- High and wide operating temperature range : -20°C to 70°C
- Industrial-rated Emission and Immunity performance

1.2 Specifications

This figure shows the important components of the converter:

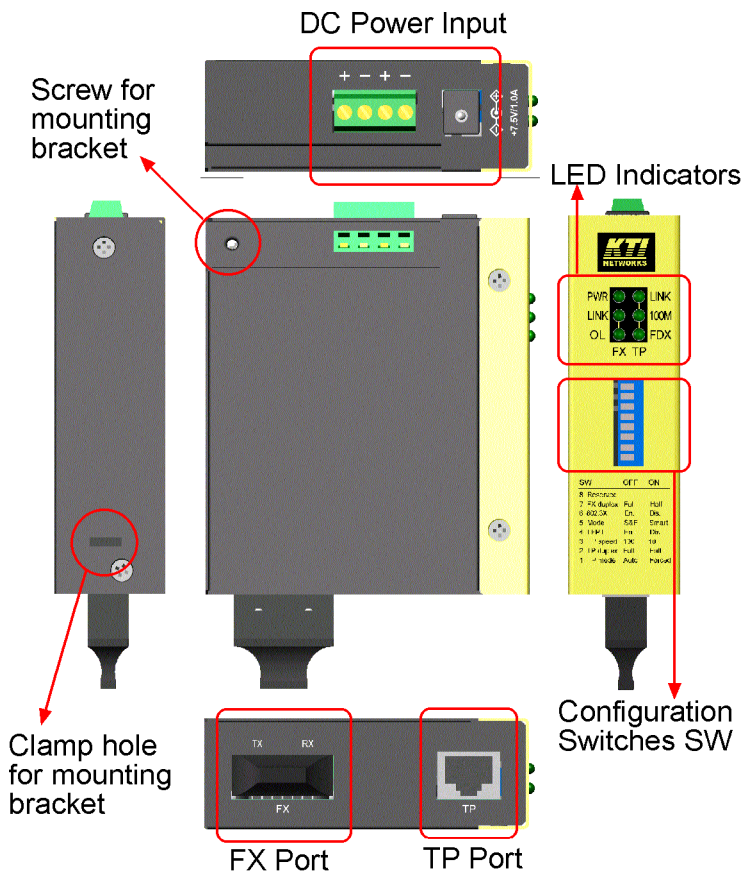

Twisted-Pair Interface (TP Port, Copper Port)

Connector	Shielded RJ-45
Pin Assignments	Auto MDI/MDI-X detection
Signal Compliance	IEEE 802.3 10Base-T, 802.3u 100Base-TX
Data Speed	10Mbps or 100Mbps
Duplex Mode	Half-duplex or Full-duplex
Configuration	Auto-negotiation capable and optional forced manual settings
Cable Types	10Mbps - Cat. 3, 4, or 5 UTP 100Mbps - Cat. 5 UTP
Supported Link Distance	Up to 100 meters

Fiber Optic Interface (FX Port)

Signal Compliance	IEEE 802.3u 100Base-FX
Connector	SC, ST or single SC (model dependent)
Data Speed	100Mbps
Duplex Mode	Full-duplex and optional half-duplex
Cable Types	Multimode (MMF) - 50/125, 62.5/125 Single mode (SMF) - 9/125
Supported Link Distance	MMF up to 2km SMF, single SMF (model dependent)
Eye Safety	IEC825 Class 1

Refer to section 1.3 for detailed optical specifications.

Configuration Setting Switches (SW)

<u>NO.</u>	<u>FUNCTION</u>	<u>SETTINGS</u>	
SW1	TP Port mode	OFF	Auto-negotiation (default)
		ON	Forced mode
SW2	TP Port Duplex	OFF	Full duplex (default)
		ON	Half duplex
SW3	TP Port Speed	OFF	100Mbps (default)
		ON	10Mbps
SW4	Link Fault Pass Through	OFF	Enable (default)
		ON	Disable
SW5	Forwarding mode	OFF	Store-and-forward always (default)
		ON	Smart-forward mode
SW6	802.3x function	OFF	Enable (default)
		ON	Disable
SW7	FX port duplex	OFF	Full duplex mode (default)
		ON	Half duplex mode

LED Indicators

<u>LED</u>	<u>DISPLAY</u>	<u>STATE</u>	<u>INTERPRETATION</u>
PWR	Power status	ON	Power on
		OFF	Power off
TP LINK	TP port link status	ON	Link up and no traffic
		OFF	Link fault
		BLINK	Rx/Tx activities
TP 100M	TP port speed status	ON	100Mbps
		OFF	10Mbps
TP FDX	TP port duplex status	ON	Full duplex
		OFF	Half duplex
		BLINK	Collisions on half duplex
FX LINK	FX port link status	ON	Link up and no traffic
		OFF	Link fault
		BLINK	Rx/Tx activities
FX OL	FX port optical link	ON	Optical signal is detected
		OFF	No optical signal

DC Power Input

Interface	Screw-type terminal block (2 sets for power wire cascading) DC Jack (-D6.3mm/+D2.0mm)
Operating Input Voltages	+7V ~ +30V(+5%)
Power consumption	1.7W @+7.5VDC input 2.4W @+24VDC input 2.6W @+30VDC input

Basic Information

Forwarding Throughput	Full wire speed at 100M full duplex 10Mbps - 14,880 pps at 64-byte packets 100Mbps - 148,800pps at 64-byte packets
Packet Types	Transparent and no modification for - IEEE 802.3 standard packets - IEEE 802.1Q VLAN tagged packets
Packet Length	Up to 1600 bytes at store-and-forward mode No limit at smart-forward mode 100to100
Flow Control	Back-pressure for half-duplex mode 802.3x pause-frame base for full duplex mode

Mechanical

Dimension (base)	W 28mm x D 82mm x H 95mm
Housing	Enclosed metal with no fan
Mounting Support	DIN-rail mounting, Panel mounting
Weight	252g

Environmental

Operating Temperature	Typical -20°C ~ 70°C (model dependent)
Storage Temperature	-20°C ~ 85°C
Relative Humidity	5% ~ 90%

Certificate

FCC

Part 15 Class B

CE/EMC

EMI EN50081-1 Class B

EMS EN55024

CE/LVD Safety

EN 60950

EN 50081-1/1992 :

EN55022:1994/A1:1995/A2:1997

CISPR Class B

EN61000-3-2:2000

Device <75W

EN61000-3-3:1995/A1:2001

Clause 5

EN 55024:1998/A1:2001

Severity Level

IEC 61000-4-2:1995 ESD Test

Contact/Air Level 4

IEC 61000-4-3:1995 RS Test

Power/Data Ports Level 3

IEC 61000-4-4:1995 EFT/BURST Test

Power/Data Ports Level 4

IEC 61000-4-5:1995 Surge Test

Level 4

IEC 61000-4-6:1996 CS Test

Power/Data Ports Level 3

IEC 61000-4-8:1993 Magnetic Field

40A/m

IEC 61000-4-11:1994 Voltage Int. Dips

Interruption >95% 250periods

Dips 30% 25periods

Dips >95% 0.5period

1.3 Model Specifications

The media converter series provides the following fiber options:

Model Specifications

<u>Model</u>	<u>FX Con.</u>	<u>Wavelength</u>	<u>Fiber Distance</u>	<u>Op. Temperature</u>
300-T	ST	1310nm	MMF 2km	-10°C ~ 70°C
300-C	SC	1310nm	MMF 2km	-10°C ~ 70°C
300-C1	SC	1310nm	MMF 2km	-20°C ~ 70°C
300-SA2	SC	1310nm	SMF 20km	-20°C ~ 70°C
300-SL2	SC	1310nm	SMF 20km	-20°C ~ 70°C
300-SL3	SC	1310nm	SMF 30km	-20°C ~ 70°C
300-SL4	SC	1310nm	SMF 40-50km	-20°C ~ 70°C

Bi-directional over single fiber

300-W3515	Bi-Di SC	Tx1310nm Rx1550nm	SMF 15-20km	-20°C ~ 70°C
300-W5315	Bi-Di SC	Tx1550nm Rx1310nm	SMF 15-20km	-20°C ~ 70°C

Optical Specifications

<u>Model</u>	<u>FX</u>	<u>Tx Power</u>	<u>Rx Sensitivity</u>	<u>Max. Rx Power</u>
300-T	MM ST	-19 ~ -14	-31 max.	-14 min.
300-C	MM SC	-19 ~ -14	-31 max.	-14 min.
300-C1	MM SC	-20 ~ -14	-31 max.	0 min.
300-SA2	SM SC	-15 ~ -8	-31 max.	-7 min.
300-SL2	SM SC	-15 ~ -7	-30 max.	-7 min.
300-SL3	SM SC	-15 ~ -8	-34 max.	0 min.
300-SL4	SM SC	-5 ~ 0	-35 max.	-3 min.
300-W3515	Bi-Di SC	-14 ~ -8	-31 max.	0 min.
300-W5315	Bi-Di SC	-14 ~ -8	-31 max.	0 min.

1.4 Special Functions

Auto MDI/MDI-X Function

This function allows the TP port to auto-detect the twisted-pair signals and adapts itself to form a valid MDI to MDI-X connection with the remote connected device automatically.

Auto-negotiation Function

When TP port is set on Auto-negotiation mode (SW1:ON), it is featured with auto-negotiation function and full capability. It performs a negotiation process for the speed and duplex configuration with the connected device automatically when each time a link is being established.

Far End Fault Function

The FX port is facilitated with this function, which conforms to IEEE 802.3u 100BASE-FX specifications. When the FX port detects a link failure on its receiving circuitry, it will send out an FEFI (Far End Fault Indication) signal to the remote connected device to indicate a remote fault is detected. It also is capable to receive FEFI signal sent from the remote link partner. Upon receiving an FEFI signal, it indicates a link failure occurred on the transmitting path. This function allows the converter to report a fiber link fault even when a link failure occurred on transmitting fiber cable.

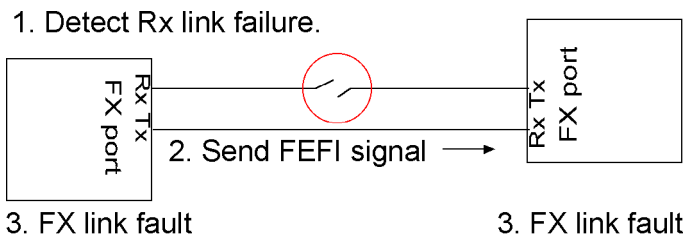

Link Fault Pass Through Function

When this function is enabled, a link fault detected on the TP port will force a link down on the FX port. Similarly, a link fault detected on the FX port will also force a link down on the TP port. As illustrated in the following figure, this function allows to pass TP link fault to the remote link partner and makes the converter like a TP cable extender.

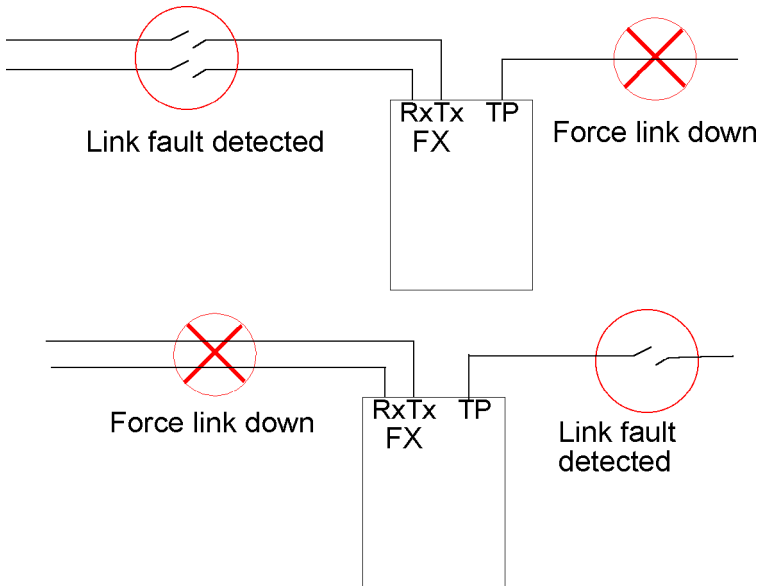

Smart-Forward Mode

Refer to Section 3.1.1 for the description of Smart-Forward.

2. Installation

2.1 Unpacking

Check that the following components have been included:

- Information CD
- The Media Converter unit
- DIN-rail mounting bracket

If any item is found missing or damaged, please contact your local reseller for replacement.

The following are available optional accessories:

- Panel Mounting Bracket
The bracket is used for mounting the converter on a panel surface.
- Commercial-rated AC power adapters:
 - Rated AC120V/60Hz DC7.5V 1A
 - Rated AC230V/50Hz DC7.5V 1A
 - Rated AC100V/50-60Hz DC7.5V 1A
 - Rated AC240V/50Hz DC7.5V 1A

The adapters are used for supplying DC power to the converter via DC power jack interface.

2.2 DIN-Rail Mounting

In the product package, a DIN-rail bracket is provided for mounting the converter in a industrial DIN-rail enclosure.

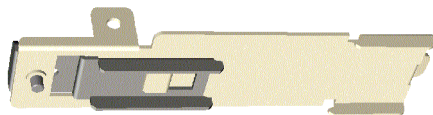

The steps to mount the converter onto a DIN-rail are:

1. Clamp the bracket into the rear of the converter. Align the bracket with the rear face of the converter and screw it onto the converter unit.

Clamp to the hole

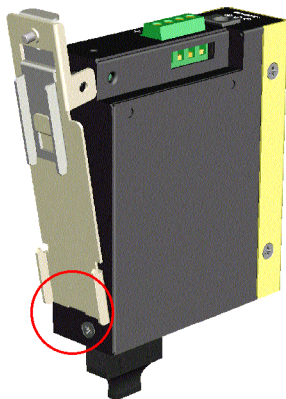

Screw the bracket on the converter

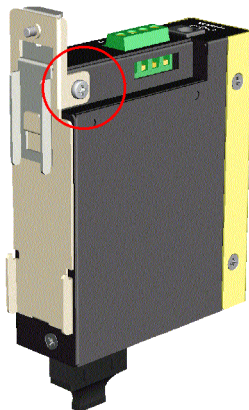

2. Unscrew and loose the mounting clamp plate of the bracket. Mount the bracket with the converter onto the DIN rail.

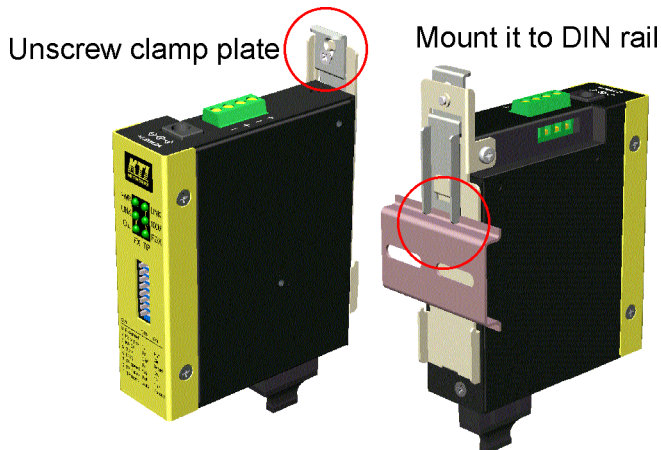

5. Screw the clamp with the bracket and make sure the converter is properly fixed on the DIN rail.

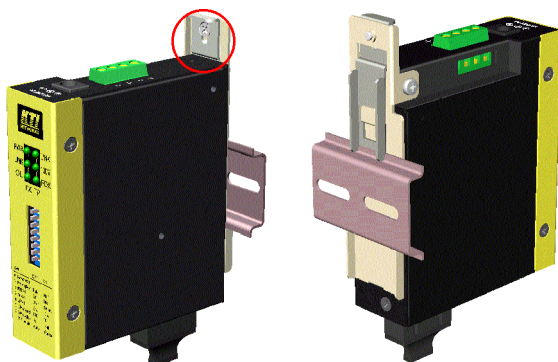

Make sure that there are proper heat dissipation from and adequate ventilation around the device.

The final mechanical dimensions after installing DIN rail mounting bracket are:

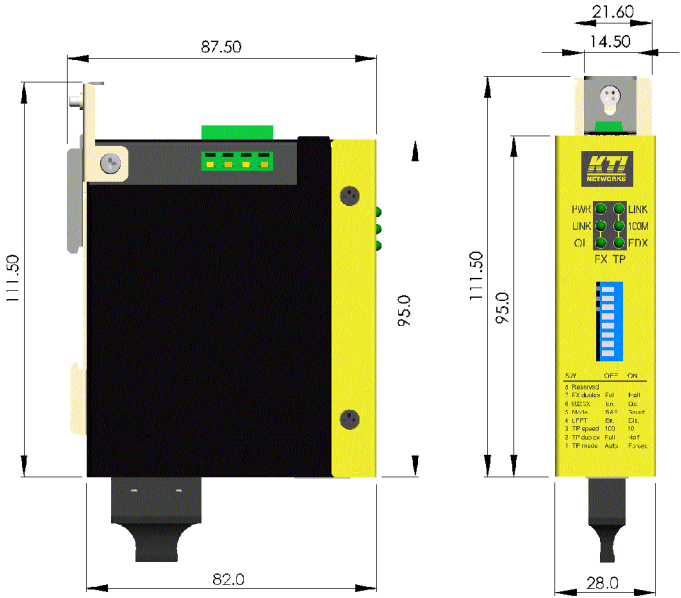

2.3 Mounting on a Panel Surface

An optional mounting bracket, as shown below is also available for mounting the converter on a panel surface such as a wall, a wood board, or a metal plate in an industrial enclosure.



To mount the converter on a panel surface, the steps are:

1. Clamp the bracket into the converter and align the bracket with the bottom surface of the converter and screw it on the converter firmly as shown below:

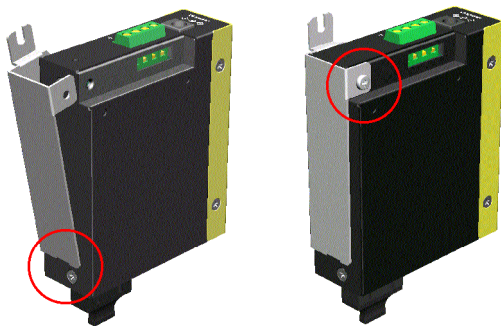

2. Mount and screw the converter on the target surface. The final dimension after bracket installation is also shown below:

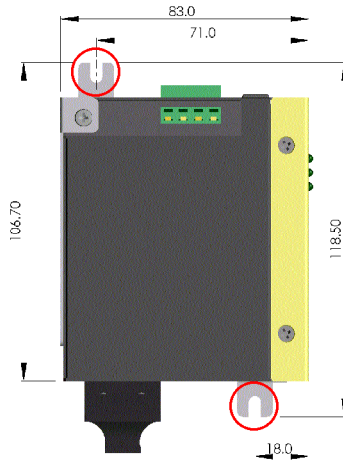

Make sure that there are proper heat dissipation from and adequate ventilation around the device. Do not place heavy objects on the device.

2.4 Applying Power

The converter provide two types of power interfaces, terminal block and DC power jack for receiving DC power input from external power supply.

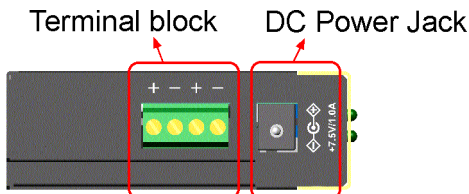

DC Power Input Specification

Operating Voltage	+7~+30VDC
Power Consumption	Max. 2.6W @30VDC

DC Power Terminal Block

Connectors	Screw-type Terminal block (2 sets)
Pin Assignments	DC1 + - Positive (+) Negative (-) terminals
	DC2 + - 2nd Positive (+) Negative (-) terminals
Power wires	24~12AWG (IEC 0.5~2.5mm ²)

The steps to install power wires to the terminal block are:

1. Loose the terminal screw to open the contact for power wire insertion. Insert power wire into the contact.

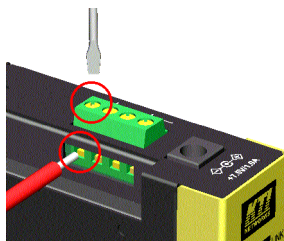

2. Screw the terminal and make sure power wire is fixed securely.

DC2 + and DC2 - can be installed with another power-pair for delivering the main power input to next converter in a cascading way.

Note: Only up to four converter units can be cascaded to receive power from one main power input source.

DC Power Jack

Connector: Jack D 6.3mm —  + D 2.0mm

AC Power Adapters: Optional commercial rated adapters are available for purchasing.

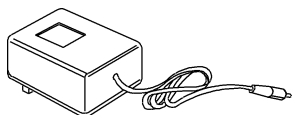

Rated AC120V/60Hz DC7.5V 1A

Rated AC230V/50Hz DC7.5V 1A

Rated AC100V/50-60Hz DC7.5V 1A

Rated AC240V/50Hz DC7.5V 1A

Steps to apply the power to the converters are:

1. Connect power adapter DC plug to the DC power jack of the converter before connecting to the AC outlet.



2. Connect the power adapter to the AC outlet.

Note: Before you begin the installation, check the AC voltage of your area. The AC power adapter which is used to supply the DC power for the unit should have the AC voltage matching the commercial power voltage in your area.

2.5 Making TP Port Connection

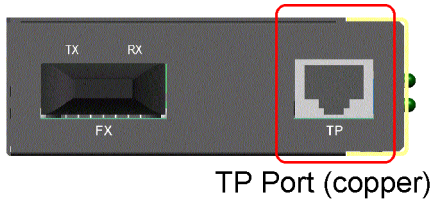

TP port is featured to support connection to :

- Auto-negotiation devices
- Auto-negotiation incapable 10BASE-T devices
- Auto-negotiation incapable 100BASE-TX devices

Network Cables

10BASE-T: 2-pair UTP Cat. 3,4,5 , EIA/TIA-568B 100-ohm STP

100BASE-TX: 2-pair UTP Cat. 5, EIA/TIA-568B 100-ohm STP

Link distance: Up to 100 meters

Note: The TP port is featured with auto MDI/MDI-X crossover detection and configuration function. No matter a straight through cable or crossover cable is connected, the TP port can sense the receiving pair automatically and configure itself to match the rule for MDI to MDI-X connection.

Configuration Setup

To make a proper connection to different devices, the following configuration settings are recommended:

<u>Link partner of TP port</u>	<u>SW1</u>	<u>SW2</u>	<u>SW3</u>
Auto-negotiation device	Off: auto	Off: full duplex	Off: 100M
Fixed 10M half duplex device	On: forced	On: half duplex	On: 10M
Fixed 100M half duplex device	On: forced	On: half duplex	Off: 100M
Fixed 10M full duplex device	On: forced	Off: full duplex	On: 10M
Fixed 100M full duplex device	On: forced	Off: full duplex	Off: 100M

2.6 Making FX Port Connection



FX Port (fiber)

FX port operates on 100Mbps and full duplex (factory default). A variety of fiber options is provided as listed in Section 1.3.

Network Cables

Multimode (MMF) - 50/125, 62.5/125

Single mode (SMF) - 9/125

3 Configuration Switches & LED Indicators

The following figure shows the locations of the configuration switches and LED indicators:

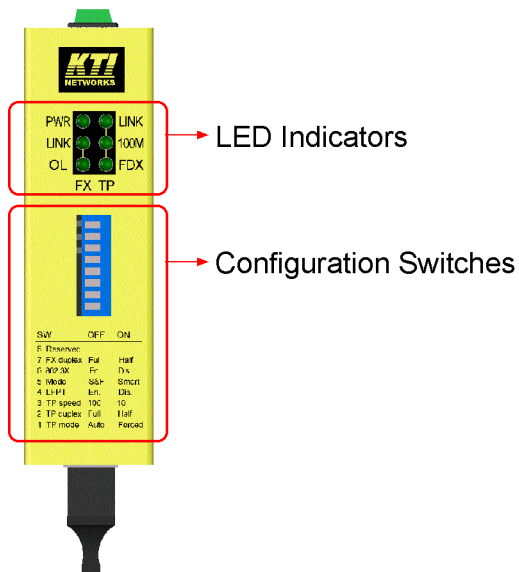

Refer to the following sections for the related functions.

3.1 Configuration Switches

<u>SW</u>	<u>FUNCTION</u>	<u>SETTING&STATE</u>	
SW1	TP Port mode	OFF	Auto-negotiation (default)
		ON	Forced mode
SW2	TP Port Duplex	OFF	Full duplex (default)
		ON	Half duplex
SW3	TP Port Speed	OFF	100Mbps (default)
		ON	10Mbps
SW4	Link Fault Pass Through	OFF	Enable (default)
		ON	Disable
SW5	Forwarding mode	OFF	Store-and-forward always (default)
		ON	Smart-forward mode
SW6	802.3x function	OFF	Enable (default)
		ON	Disable
SW7	FX port duplex	OFF	Full duplex mode (default)
		ON	Half duplex mode
SW8	Reserved		

Note:

- 1. SW1, SW2, SW3 are used for configuring the TP port especially when connecting to a link partner port which is not auto-negotiation capable. Refer to section 2.5 for details.*
- 2. SW4 is used to enable or disable Link Fault Pass Through function. Refer to section 1.4 for details about Link Fault Pass Through function. Also note that the LED display has different indication when the function is enabled and disabled.*

3.1.1 Forwarding Mode Setting SW5

The following table lists the forward method used in different TP to FX conversions:

<u>SW5 Setting</u>	<u>TP port to/from FX port</u>	<u>Forward method</u>
Store-and-forward	10BASE-T to 100BASE-FX	Store and forward
	100BASE-TX to 100BASE-FX	Store and forward
Smart-forward	10BASE-T to 100BASE-FX	Store and forward
	100BASE-TX to 100BASE-FX	Direct conversion

On smart-forward mode, the converter can change to direct conversion automatically when it detects same speed on both TP port and FX port. Direct conversion method converts the signal between TP port and FX port without storing the received packet on one port then forwarding to another port. The media converter operates with the minimum latency.

Note:

- 1. In direct conversion, be sure both devices connected to the TP port and FX port have same duplex mode for proper transmission.*
- 2. In direct conversion, 802.3x function is disabled and the media converter will not generate pause frame, but just forwards the received pause frame directly from one port to another port.*
- 3. In direct conversion, the media converter is not limited to the maximal length of the receiving packets.*

3.1.2 802.3x Function Setting SW6

IEEE 802.3x function is the flow control method used for full duplex operation on TP port and FX port under store and forward mode. This method uses pause frames for one port to stop further transmission from its link partner.

3.1.3 FX Duplex Setting SW7

This setting is used to set the duplex mode of the FX port. It is recommended to use full duplex mode for FX connection unless its link partner is a fixed half duplex device. Half duplex mode will shorten the connection distance. The following table lists the maximum **MMF** cable length connecting to different devices:

<u>Link Partner of FX Port</u>	<u>Distance (MMF cable)</u>
Network card half-duplex fiber port	400m
Network card full-duplex fiber port	2km
Class I hub half-duplex fiber port	160m
2 Class II hub half-duplex fiber port	112m
Switched half-duplex fiber port	400m
Switched half-duplex fiber port	2km

Note: For SMF connection, be sure the link partner is a full duplex device and set SW7 to full duplex mode for the FX port.

3.1.4 Factory Default Settings

The factory default settings are as follows:

SW1	OFF	TP port mode - auto-negotiation
SW2	OFF	TP port - full duplex
SW3	OFF	TP port - 100Mbps
SW4	OFF	Enable Link Fault Pass Through function
SW5	OFF	Store-and-forward always mode
SW6	OFF	Enable IEEE 802.3x flow control function
SW7	OFF	FX port - full duplex
SW8	OFF	Reserved

3.2 LED Indicators

Link Fault Pass Through Function is disabled

<u>LED</u>	<u>DISPLAY</u>	<u>STATUS & INTERPRETATION</u>	
PWR	Power status	ON	Power on
		OFF	Power off
TPLINK	TP port link status	ON	Link up and no traffic
		OFF	Link fault
		Blink	Rx/Tx activities
TP 100M	TP port speed status	ON	100Mbps
		OFF	10Mbps
TPFDX	TP port duplex status	ON	Full duplex
		OFF	Half duplex
		Blink	Collisions on half duplex
FX LINK	FX port link status	ON	Link up and no traffic
		OFF	Link fault
		Blink	Rx/Tx activities
FX OL	FX port optical link	ON	Optical signal is detected
		OFF	No optical signal is detected

Link Fault Pass Through Function is enabled

<u>TPLINK</u>	<u>FXLINK</u>	<u>FX OL</u>	<u>INTERPRETATION</u>
ON	ON	ON	Both TP and FX ports link up
OFF	OFF	ON	(1) TP port link fault or (2) FX port received FEFI signal (FX port Tx path failed.)
OFF	OFF	OFF	(1) TP port link fault or (2) FX port Rx link failure detected