

Lötstift gerade
mit Durchgangsloch

Solder pin straight
with through hole

Buchsenleiste / Socket connector

Stiftleiste / Plug connector

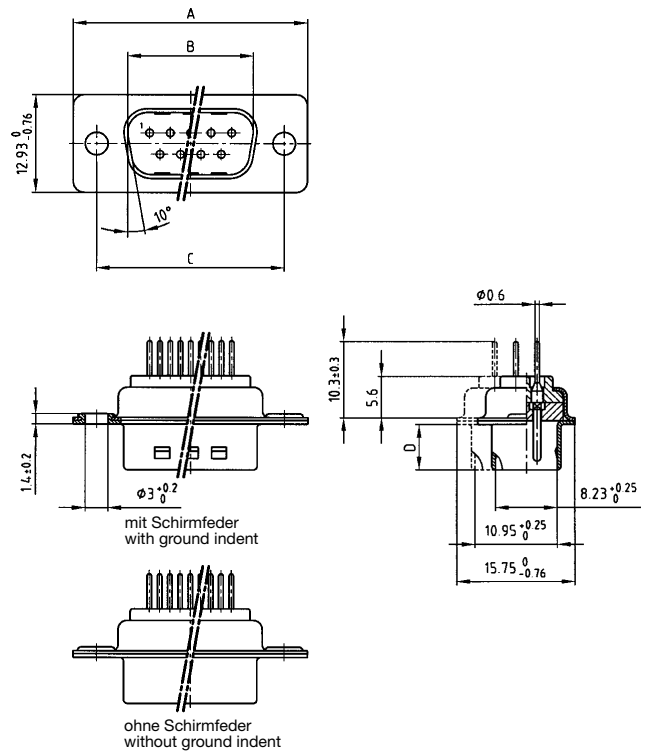
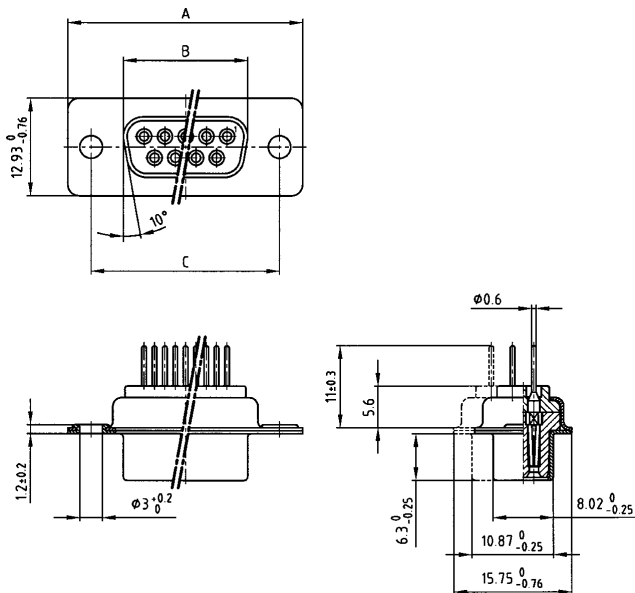

Polzahl No. of pos.	A - 0,76	B - 0,25	C
9	31,19	16,46	25,00 $\pm 0,13$
15	39,52	24,79	33,30 $\pm 0,15$
25	53,42	38,50	47,04 $\pm 0,13$
37	69,70	54,96	63,50 $\pm 0,13$
50	67,31	52,55	61,10 $\pm 0,14$

Polzahl No. of pos.	A - 0,76	B + 0,25	C	D - 0,30
9	31,19	16,79	25,00 $\pm 0,13$	6,12
15	39,52	25,12	33,30 $\pm 0,15$	6,12
25	53,42	38,84	47,04 $\pm 0,13$	5,99
37	69,70	55,30	63,50 $\pm 0,13$	5,99
50	67,31	52,68	61,10 $\pm 0,14$	5,99

Kat 1 i F6A

Bestellnummern – Part numbers

Kat 1 i F7A

Polzahl No. of Pos.	Buchsenleiste / Socket connector	
	gelb chromatiert yellow zinc	verzinkt tin-plated
9	162 A 10069 X	164 A 10069 X
15	162 A 10079 X	164 A 10079 X
25	162 A 10089 X	164 A 10089 X
37	162 A 10099 X	164 A 10099 X
50	162 A 10109 X	164 A 10109 X

Polzahl No. of Pos.	Stiftleiste / Plug connector	
	gelb chromatiert ohne Schirmfederung yellow zinc without ground indent	verzinkt mit Schirmfederung tin-plated with ground indent
9	161 A 10069 X	163 A 11119 X
15	161 A 10079 X	163 A 11129 X
25	161 A 10089 X	163 A 11139 X
37	161 A 10099 X	163 A 11149 X
50	161 A 10109 X	163 A 11159 X