

Omega™ 4K/UHD Wallplate Transmitter for USB-C with HDBaseT Output and USB

AT-OME-EX-TX-WPC



The Atlona **AT-OME-EX-TX-WPC** is an HDBaseT transmitter with USB-C input. It sends video up to 4K/60 4:2:0, plus embedded audio, control, and USB over distances up to 330 feet (100 meters). It features a US one-gang, Decora-style wallplate form factor, and includes interchangeable black and white wallplates and faceplates. Part of the Omega™ Series of integration products for modern AV communications and collaboration, the OME-EX-TX-WPC is HDCP 2.2 compliant and extends RS-232 control signals. The USB-C input is ideal for AV interfacing with newer Mac®, Chromebook™, and Windows® PCs, as well as smartphones and tablets. With a matching HDBaseT receiver, the integrated USB extension addresses the challenge of connecting between USB devices at remote locations, and is ideal for software video conferencing and touch or interactive displays. The OME-EX-TX-WPC includes a PC host interface over USB-C, plus a USB 2.0 interface for a peripheral device such as a speakerphone, microphone, or keyboard and mouse*. This transmitter is ideal for use with Omega Series receivers as well as switchers with HDBaseT inputs.

Package Contents

- | | |
|-----------------------------|------------------------------------|
| 1 x AT-OME-EX-TX-WPC | 1 x Black Decora® wallplate |
| 1 x White faceplate | 4 x Mounting screws |
| 1 x White Decora® wallplate | 1 x USB-C to USB-C cable, 2 meters |
| 1 x Black faceplate | 1 x Installation Guide |



IMPORTANT: Visit <http://www.atlona.com/product/AT-OME-EX-TX-WPC> for the latest firmware updates and User Manual.

* The AT-OME-EX-TX-WPC is not compatible with the AT-UHD-HDVS-300 system for extending USB.

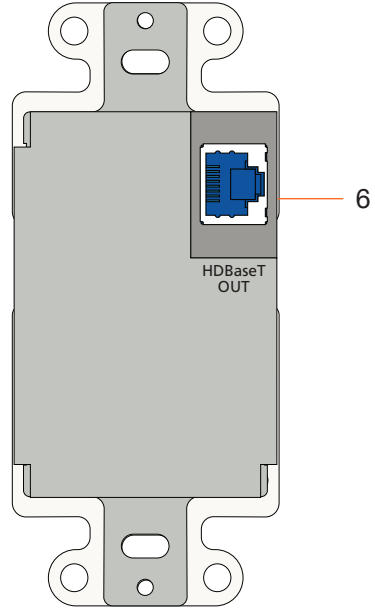
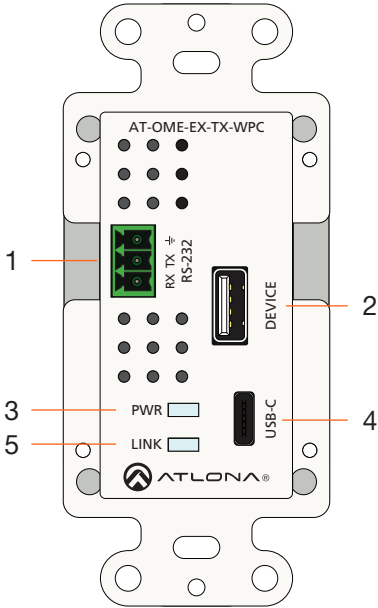

- 1 RS-232**
Connect an RS-232 control system to this port. Connect the included 3-pin captive screw block to this receptacle. Refer to [RS-232 \(page 3\)](#) for more information. Note that this port is covered by a plate and must be removed to expose the RS-232 port.
- 2 DEVICE**
Connect a USB device, such as a speakerphone, to this port. This port provides 5 W of power.
- 3 PWR**
This LED indicator glows solid green when the unit is powered. Refer to [LED Indicators \(page 6\)](#) for more information.

- 4 USB-C**
Connect a USB-C cable from this port to a UHD/HD source.
- 5 LINK**
This LED indicator glows solid amber to indicate that the HDBaseT signal integrity is good. Refer to [LED Indicators \(page 6\)](#) for more information.
- 6 HDBaseT OUT**
Connect a category cable from this port to the **HDBaseT IN** port of the AT-OME-EX-RX or other PoE-compatible receiver.

RS-232

The AT-OME-EX-TX-WPC provides an **RS-232** port which allows communication between a control system and an RS-232 device. This step is optional.

1. Gently remove the RS-232 cover from the faceplate using the tip of a small regular screwdriver.

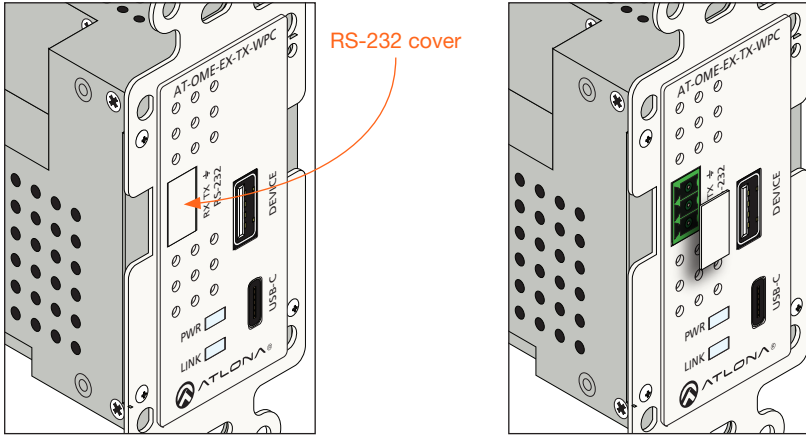

2. Use wire strippers to remove a portion of the RS-232 cable jacket.
3. Remove at least 3/16" (5 mm) from the insulation of the RX, TX, and GND wires.
4. Insert the TX, RX, and GND wires into correct terminal using the included 3-pin captive screw connector.
5. Connect the opposite end of the cable to the control system.

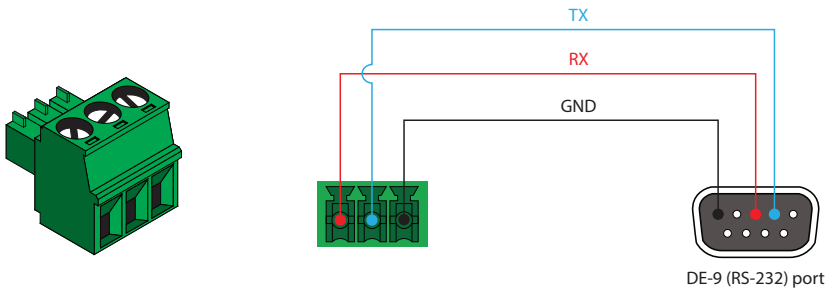

i **NOTE:** Typical DE-9 connectors use pin 2 for TX, pin 3 for RX, and pin 5 for ground. On some devices functions of pins 2 and 3 are reversed.

Faceplate Removal and Assembly

Removal of the faceplate requires that the AT-OME-EX-TX-WPC be disassembled from the electrical box or mud ring. A small Phillips-head screwdriver is required to remove the faceplate.

1. Unscrew the four Phillips-head screws from the sides of the faceplate, as shown:

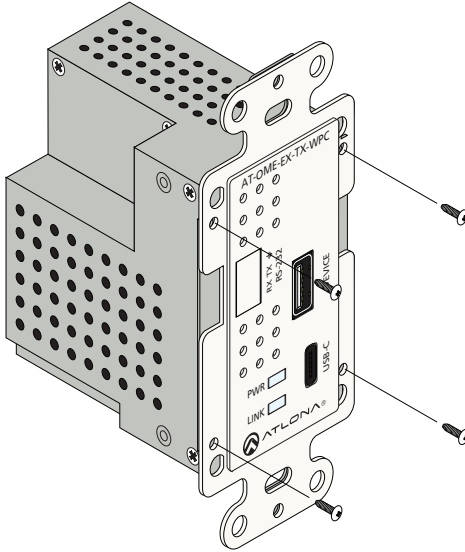

2. Gently remove the faceplate by pulling it toward you.
3. Attach the new faceplate, then secure it using the four Phillips-head screws. Do not over-tighten or apply high-torque devices to the screws. Doing so may damage the faceplate and/or the screws.
4. Install the AT-OME-EX-TX-WPC into the electrical box or mud ring.
5. Reattach the wallplate.

Installation

1. Connect a USB-C cable from the source to the **USB-C** port.
2. OPTIONAL: Connect a USB device, such as a speakerphone to the **DEVICE** port. This port provide 5 W of power.
3. Connect a category cable, from the **HDBaseT OUT** port on the rear of the transmitter, to the **HDBaseT IN** port on the receiver.
4. OPTIONAL: Connect an RS-232 cable between a control system and the **RS-232** port on the transmitter. Refer to **RS-232 (page 3)** for more information.

Cable Recommendation Guidelines

Refer to the tables below for recommended cabling when using Altona products with HDBaseT. The green bars indicate the signal quality when using each type of cable. Higher-quality signals are represented by more bars.

Core	Shielding	CAT5e	CAT6	CAT6a	CAT7
Solid	UTP (unshielded)	■	■■■	■■■■	N/A
	STP (shielded)	■■	■■■■	■■■■■	■■■■■





IMPORTANT: Stranded or patch cables are not recommended due to performance issues.



Cable*	Max. Distance @ 4K	Max. Distance @ 1080p
CAT5e	295 feet (90 meters)	330 feet (100 meters)
CAT6 / CAT6a / CAT7	330 feet (100 meters)	330 feet (100 meters)

*Atlona recommends TIA/EIA 568-B termination for optimal performance.

LED Indicators

The **PWR** and **LINK** LED indicator on both the transmitter and receiver unit provides basic information on the current status of the AT-OME-EX-TX-WPC.

PWR		Description
Solid green		Unit is powered. Normal operating mode.
Blinking green		Unit is in firmware update mode. Refer to Updating the Firmware (page 7) for more information.
Off		Unit is not powered. <ul style="list-style-type: none"> Make sure that the category cable between the HDBaseT IN port on the transmitter and the HDBaseT OUT port on the receiver is secure. Make sure that the power supply, at the receiver, is connected to an active AC outlet.

LINK		Description
Solid amber		The link integrity between the transmitter and the receiver is good.
Blinking amber		Poor signal integrity between the transmitter and the receiver. <ul style="list-style-type: none"> Make sure that the category cable between the HDBaseT IN port on the transmitter and the HDBaseT OUT port on the receiver is secure. The category cable may be compromised. Try using a different category cable. Make sure that the cable is solid core. Stranded or patch cables are not recommended.
Off		The link integrity between the transmitter and the receiver is compromised. <ul style="list-style-type: none"> Check the category cable between the HDBaseT IN port on the transmitter and the HDBaseT OUT port on the receiver.

Updating the Firmware

Requirements:

- AT-OME-EX-TX-WPC
- Firmware file
- Computer running Windows
- Micro-USB to USB-A cable



NOTE: The update process can take up to five minutes to complete.

1. Disconnect power from the unit.
2. Remove the faceplate to access the hidden “firmware update” button, located above the PWR LED indicator. Refer to [Faceplate Removal and Assembly \(page 4\)](#) for more information.

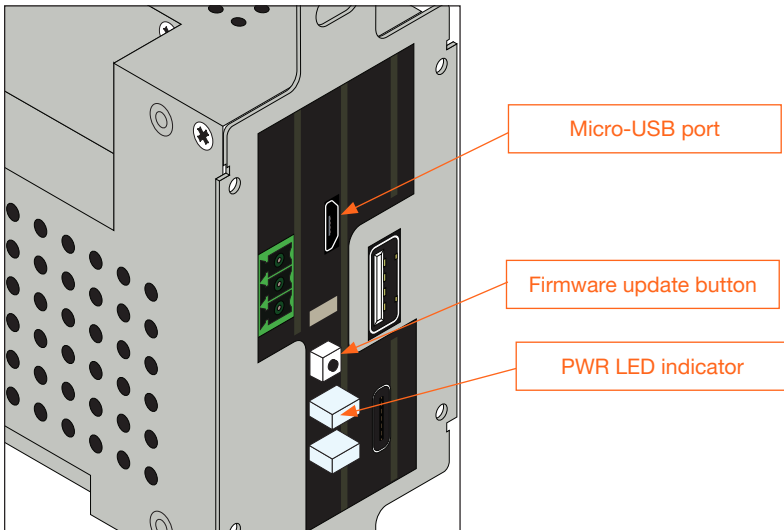

3. Connect a micro-USB to USB-A cable between the PC and the micro-USB port on the unit.
4. Simultaneously press and hold the firmware update button, while reconnecting the power. The **PWR** LED indicator will be blinking green.

5. The USB UPDATE folder will be displayed. If this folder is not displayed, automatically, select the USB UPDATE drive from Windows Explorer.

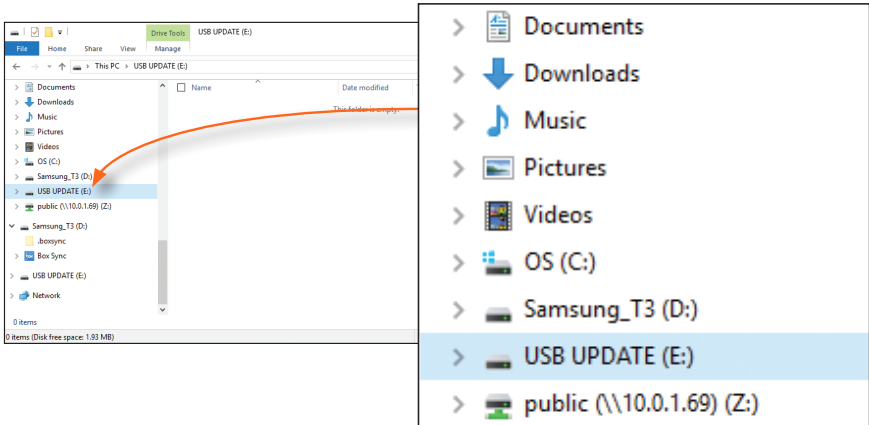

6. Delete all files from the USB UPDATE drive, if any are present.
7. Drag-and-drop the firmware file to the drive.
8. The **PWR** LED indicator, on the front panel, will flash green while the unit is being updated. Do not disconnect the USB cable during the update process. When the **PWR** LED stops flashing and is solid green, the update process will be complete.



Atlona, Inc. (“Atlona”) Limited Product Warranty

Coverage

Atlona warrants its products will substantially perform to their published specifications and will be free from defects in materials and workmanship under normal use, conditions and service.

Under its Limited Product Warranty, Atlona, at its sole discretion, will either:

- repair or facilitate the repair of defective products within a reasonable period of time, restore products to their proper operating condition and return defective products free of any charge for necessary parts, labor and shipping.

OR

- replace and return, free of charge, any defective products with direct replacement or with similar products deemed by Atlona to perform substantially the same function as the original products.

OR

- refund the pro-rated value based on the remaining term of the warranty period, not to exceed MSRP, in cases where products are beyond repair and/or no direct or substantially similar replacement products exist.

Repair, replacement or refund of Atlona products is the purchaser’s exclusive remedy and Atlona liability does not extend to any other damages, incidental, consequential or otherwise.

This Limited Product Warranty extends to the original end-user purchaser of Atlona products and is non-transferrable to any subsequent purchaser(s) or owner(s) of these products.

Coverage Periods

Atlona Limited Product Warranty Period begins on the date of purchase by the end-purchaser. The date contained on the end-purchaser’s sales or delivery receipt is the proof purchase date.

Limited Product Warranty Terms – New Products

- 10 years from proof of purchase date for hardware/electronics products purchased on or after June 1, 2013.
- 3 years from proof of purchase date for hardware/electronics products purchased before June 1, 2013.
- Lifetime Limited Product Warranty for all cable products.

Limited Product Warranty Terms – Refurbished (B-Stock) Products and Discontinued Products

- 3 years from proof of purchase date for all Refurbished (B-Stock) and Discontinued hardware and electronic products purchased on or after June 1, 2013.

Remedy

Atlona recommends that end-purchasers contact their authorized Atlona dealer or reseller from whom they purchased their products. Atlona can also be contacted directly. Visit www.atlona.com for Atlona's contact information and hours of operation. Atlona requires that a dated sales or delivery receipt from an authorized dealer, reseller or end-purchaser is provided before Atlona extends its warranty services. Additionally, a return merchandise authorization (RMA) and/or case number, is required to be obtained from Atlona in advance of returns.

Atlona requires that products returned are properly packed, preferably in the original carton, for shipping. Cartons not bearing a return authorization or case number will be refused. Atlona, at its sole discretion, reserves the right to reject any products received without advanced authorization. Authorizations can be requested by calling 1-877-536-3976 (US toll free) or 1-408-962-0515 (US/international) or via Atlona's website at www.atlona.com.

Exclusions

This Limited Product Warranty excludes:

- Damage, deterioration or malfunction caused by any alteration, modification, improper use, neglect, improper packaging or shipping (such claims must be presented to the carrier), lightning, power surges, or other acts of nature.
- Damage, deterioration or malfunction resulting from the installation or removal of this product from any installation, any unauthorized tampering with this product, any repairs attempted by anyone unauthorized by Atlona to make such repairs, or any other cause which does not relate directly to a defect in materials and/or workmanship of this product.
- Equipment enclosures, cables, power supplies, batteries, LCD displays, and any accessories used in conjunction with the product(s).
- Products purchased from unauthorized distributors, dealers, resellers, auction websites and similar unauthorized channels of distribution.

Disclaimers

This Limited Product Warranty does not imply that the electronic components contained within Atlona's products will not become obsolete nor does it imply Atlona products or their electronic components will remain compatible with any other current product, technology or any future products or technologies in which Atlona's products may be used in conjunction with. Atlona, at its sole discretion, reserves the right not to extend its warranty offering in instances arising outside its normal course of business including, but not limited to, damage inflicted to its products from acts of god.

Limitation on Liability

The maximum liability of Atlona under this limited product warranty shall not exceed the original Atlona MSRP for its products. To the maximum extent permitted by law, Atlona is not responsible for the direct, special, incidental or consequential damages resulting from any breach of warranty or condition, or under any other legal theory. Some countries, districts or states do not allow the exclusion or limitation of relief, special, incidental, consequential or indirect damages, or the limitation of liability to specified amounts, so the above limitations or exclusions may not apply to you.



Exclusive Remedy

To the maximum extent permitted by law, this limited product warranty and the remedies set forth above are exclusive and in lieu of all other warranties, remedies and conditions, whether oral or written, express or implied. To the maximum extent permitted by law, Atlona specifically disclaims all implied warranties, including, without limitation, warranties of merchantability and fitness for a particular purpose. If Atlona cannot lawfully disclaim or exclude implied warranties under applicable law, then all implied warranties covering its products including warranties of merchantability and fitness for a particular purpose, shall provide to its products under applicable law. If any product to which this limited warranty applies is a “Consumer Product” under the Magnuson-Moss Warranty Act (15 U.S.C.A. §2301, ET SEQ.) or other applicable law, the foregoing disclaimer of implied warranties shall not apply, and all implied warranties on its products, including warranties of merchantability and fitness for the particular purpose, shall apply as provided under applicable law.

Other Conditions

Atlona’s Limited Product Warranty offering gives legal rights, and other rights may apply and vary from country to country or state to state. This limited warranty is void if (i) the label bearing the serial number of products have been removed or defaced, (ii) products are not purchased from an authorized Atlona dealer or reseller. A comprehensive list of Atlona’s authorized distributors, dealers and resellers can be found at www.atlona.com.



English Declaration of Conformity

The English version can be found under the resources tab at:

<https://atlona.com/product/at-ome-ex-tx-wpc/>.



Chinese Declaration of Conformity 中国RoHS合格声明

由SKU列出於:

<https://atlona.com/about-us/china-rohs/>.

