

OmniStream™ R-Type Single-Channel Networked AV Decoder



Version Information

Version	Release Date	Notes
1	Mar 2018	Initial release
2	Jul 2018	Includes updates to 1.2.1 firmware; AMS updates
3	Nov 2018	1.2.2 firmware; Dolby Vision decoding/licensing, fast switching
4	Aug 2019	Documentation updated to support AMS 2.4.0
5	Sep 2019	Documentation updated to support OmniStream 1.2.5; various bug fixes and added Portrait Mode (page 44) for Video Walls.
6	Oct 2019	Updated documentation to include support for Velocity 1.6.2 - Portrait orientation, rotation for Creating Presets (page 59) and Creating and Using Drop Zones (page 64).
7	Jan 2020	Velocity video wall screen shots updated to match Velocity 2.0.0.2.
8	Feb 2020	Added web server documentation reflecting changes to 1.2.6 firmware. Refer to the release notes for a complete listing features and bug fixes. - LLDP menu item added. Refer to the LLDP page (page 115).
9	Jan 2021	Firmware 1.2.7 - FPGA information now available under the System Information page. Refer to System information page (page 98) for more information. - NTP server set to <code>pool.ntp.org</code> , by default; change under the System Information page. Refer to System information page (page 98) for more information. - Custom SAP multicast address can now be configured under SAP page. Refer to SAP page (page 100) for more information. - Telnet session can now be disabled under the Network page. Refer to Network page (page 112) for more information. - Fast-switching timeout interval can now be set. Refer to Fast Switching (page 32) for more information. - Fast-switching now supports resolutions up to 1920x1200. - Output frame rate can now be adjusted. Refer to HDMI Output page (page 104) for more information.

Sales, Marketing, and Customer Support

Main Office

Atlona Incorporated
70 Daggett Drive
San Jose, CA 95134
United States

Office: +1.877.536.3976 (US Toll-free)
Office: +1.408.962.0515 (US/International)

Sales and Customer Service Hours
Monday - Friday: 6:00 a.m. - 4:30 p.m. (PST)

<http://www.atlona.com/>

International Headquarters

Atlona International AG
Tödistrasse 18
8002 Zürich
Switzerland

Office: +41 43 508 4321

Sales and Customer Service Hours
Monday - Friday: 09:00 - 17:00 (UTC +1)

Operating Notes

- The Atlona Management System (AMS) is a free downloadable application from Atlona that provides network configuration assistance for this product. This application is available only for the Windows® Operating System and can be downloaded from the Atlona web site.



IMPORTANT: Visit <http://www.atlona.com/product/AT-OMNI-521> for the latest firmware updates and User Manual.



NOTE: Scaling and deinterlacing is not supported at 1080i.

Atlona, Inc. (“Atlona”) Limited Product Warranty

Coverage

Atlona warrants its products will substantially perform to their published specifications and will be free from defects in materials and workmanship under normal use, conditions and service.

Under its Limited Product Warranty, Atlona, at its sole discretion, will either:

- repair or facilitate the repair of defective products within a reasonable period of time, restore products to their proper operating condition and return defective products free of any charge for necessary parts, labor and shipping.

OR

- replace and return, free of charge, any defective products with direct replacement or with similar products deemed by Atlona to perform substantially the same function as the original products.

OR

- refund the pro-rated value based on the remaining term of the warranty period, not to exceed MSRP, in cases where products are beyond repair and/or no direct or substantially similar replacement products exist.

Repair, replacement or refund of Atlona products is the purchaser’s exclusive remedy and Atlona liability does not extend to any other damages, incidental, consequential or otherwise.

This Limited Product Warranty extends to the original end-user purchaser of Atlona products and is non-transferrable to any subsequent purchaser(s) or owner(s) of these products.

Coverage Periods

Atlona Limited Product Warranty Period begins on the date of purchase by the end-purchaser. The date contained on the end-purchaser’s sales or delivery receipt is the proof purchase date.

Limited Product Warranty Terms – New Products

- 10 years from proof of purchase date for hardware/electronics products purchased on or after June 1, 2013.
- 3 years from proof of purchase date for hardware/electronics products purchased before June 1, 2013.
- Lifetime Limited Product Warranty for all cable products.

Limited Product Warranty Terms – Refurbished (B-Stock) Products and Discontinued Products

- 3 years from proof of purchase date for all Refurbished (B-Stock) and Discontinued hardware and electronic products purchased on or after June 1, 2013.

Remedy

Atlona recommends that end-purchasers contact their authorized Atlona dealer or reseller from whom they purchased their products. Atlona can also be contacted directly. Visit atlona.com for Atlona’s contact information and hours of operation. Atlona requires that a dated sales or delivery receipt from an authorized dealer, reseller or end-purchaser is provided before Atlona extends its warranty services. Additionally, a return merchandise authorization (RMA) and/or case number, is required to be obtained from Atlona in advance of returns.

Atlona requires that products returned are properly packed, preferably in the original carton, for shipping. Cartons not bearing a return authorization or case number will be refused. Atlona, at its sole discretion, reserves the right to reject any products received without advanced authorization. Authorizations can be requested by calling 1-877-536-3976 (US toll free) or 1-408- 962-0515 (US/international) or via Atlona’s website at atlona.com.

Exclusions

This Limited Product Warranty excludes:

- Damage, deterioration or malfunction caused by any alteration, modification, improper use, neglect, improper packaging or shipping (such claims must be presented to the carrier), lightning, power surges, or other acts of nature.

Atlona, Inc. (“Atlona”) Limited Product Warranty

- Damage, deterioration or malfunction resulting from the installation or removal of this product from any installation, any unauthorized tampering with this product, any repairs attempted by anyone unauthorized by Atlona to make such repairs, or any other cause which does not relate directly to a defect in materials and/or workmanship of this product.
- Equipment enclosures, cables, power supplies, batteries, LCD displays, and any accessories used in conjunction with the product(s).
- Products purchased from unauthorized distributors, dealers, resellers, auction websites and similar unauthorized channels of distribution.

Disclaimers

This Limited Product Warranty does not imply that the electronic components contained within Atlona’s products will not become obsolete nor does it imply Atlona products or their electronic components will remain compatible with any other current product, technology or any future products or technologies in which Atlona’s products may be used in conjunction with. Atlona, at its sole discretion, reserves the right not to extend its warranty offering in instances arising outside its normal course of business including, but not limited to, damage inflicted to its products from acts of god.

Limitation on Liability

The maximum liability of Atlona under this limited product warranty shall not exceed the original Atlona MSRP for its products. To the maximum extent permitted by law, Atlona is not responsible for the direct, special, incidental or consequential damages resulting from any breach of warranty or condition, or under any other legal theory. Some countries, districts or states do not allow the exclusion or limitation of relief, special, incidental, consequential or indirect damages, or the limitation of liability to specified amounts, so the above limitations or exclusions may not apply to you.

Exclusive Remedy

To the maximum extent permitted by law, this limited product warranty and the remedies set forth above are exclusive and in lieu of all other warranties, remedies and conditions, whether oral or written, express or implied. To the maximum extent permitted by law, Atlona specifically disclaims all implied warranties, including, without limitation, warranties of merchantability and fitness for a particular purpose. If Atlona cannot lawfully disclaim or exclude implied warranties under applicable law, then all implied warranties covering its products including warranties of merchantability and fitness for a particular purpose, shall provide to its products under applicable law. If any product to which this limited warranty applies is a “Consumer Product” under the Magnuson-Moss Warranty Act (15 U.S.C.A. §2301, ET SEQ.) or other applicable law, the foregoing disclaimer of implied warranties shall not apply, and all implied warranties on its products, including warranties of merchantability and fitness for the particular purpose, shall apply as provided under applicable law.

Other Conditions

Atlona’s Limited Product Warranty offering gives legal rights, and other rights may apply and vary from country to country or state to state. This limited warranty is void if (i) the label bearing the serial number of products have been removed or defaced, (ii) products are not purchased from an authorized Atlona dealer or reseller. A comprehensive list of Atlona’s authorized distributors, dealers and resellers can be found at www.atlona.com.

Important Safety Information



CAUTION: TO REDUCE THE RISK OF ELECTRIC SHOCK DO NOT OPEN ENCLOSURE OR EXPOSE TO RAIN OR MOISTURE. NO USER-SERVICEABLE PARTS INSIDE REFER SERVICING TO QUALIFIED SERVICE PERSONNEL.



The exclamation point within an equilateral triangle is intended to alert the user to the presence of important operating and maintenance instructions in the literature accompanying the product.



The information bubble is intended to alert the user to helpful or optional operational instructions in the literature accompanying the product.

1. Read these instructions.
2. Keep these instructions.
3. Heed all warnings.
4. Follow all instructions.
5. Do not use this product near water.
6. Clean only with a dry cloth.
7. Do not block any ventilation openings. Install in accordance with the manufacturer's instructions.
8. Do not install or place this product near any heat sources such as radiators, heat registers, stoves, or other apparatus (including amplifiers) that produce heat.
9. Do not defeat the safety purpose of a polarized or grounding-type plug. A polarized plug has two blades with one wider than the other. A grounding type plug has two blades and a third grounding prong. The wide blade or the third prong are provided for your safety. If the provided plug does not fit into your outlet, consult an electrician for replacement of the obsolete outlet.
10. Protect the power cord from being walked on or pinched particularly at plugs, convenience receptacles, and the point where they exit from the product.
11. Only use attachments/accessories specified by Atlona.
12. To reduce the risk of electric shock and/or damage to this product, never handle or touch this unit or power cord if your hands are wet or damp. Do not expose this product to rain or moisture.
13. Unplug this product during lightning storms or when unused for long periods of time.
14. Refer all servicing to qualified service personnel. Servicing is required when the product has been damaged in any way, such as power-supply cord or plug is damaged, liquid has been spilled or objects have fallen into the product, the product has been exposed to rain or moisture, does not operate normally, or has been dropped.



FCC Compliance

FCC Compliance and Advisory Statement: This hardware device complies with Part 15 of the FCC rules. Operation is subject to the following two conditions: 1) this device may not cause harmful interference, and 2) this device must accept any interference received including interference that may cause undesired operation. This equipment has been tested and found to comply with the limits for a Class A digital device, pursuant to Part 15 of the FCC Rules. These limits are designed to provide reasonable protection against harmful interference in a commercial installation. This equipment generates, uses, and can radiate radio frequency energy and, if not installed or used in accordance with the instructions, may cause harmful interference to radio communications. However there is no guarantee that interference will not occur in a particular installation. If this equipment does cause harmful interference to radio or television reception, which can be determined by turning the equipment off and on, the user is encouraged to try to correct the interference by one or more of the following measures: 1) reorient or relocate the receiving antenna; 2) increase the separation between the equipment and the receiver; 3) connect the equipment to an outlet on a circuit different from that to which the receiver is connected; 4) consult the dealer or an experienced radio/TV technician for help. Any changes or modifications not expressly approved by the party responsible for compliance could void the user's authority to operate the equipment. Where shielded interface cables have been provided with the product or specified additional components or accessories elsewhere defined to be used with the installation of the product, they must be used in order to ensure compliance with FCC regulations.

Copyright, Trademark, and Registration

© 2021 Atlona Inc. All rights reserved. "Atlona" and the Atlona logo are registered trademarks of Atlona Inc. Pricing, specifications and availability subject to change without notice. Actual products, product images, and online product images may vary from images shown here.

HDMI™ The terms HDMI, HDMI High-Definition Multimedia Interface, and the HDMI Logo are trademarks or registered trademarks of HDMI licensing Administrator, Inc.

Dolby, Dolby Atmos, and the double-D symbol are registered trademarks of Dolby Laboratories Licensing Corporation.

For DTS patents, see <http://patents.dts.com>. Manufactured under license from DTS, Inc. DTS, the Symbol, DTS and the Symbol together, and Digital Surround are registered trademarks and/or trademarks of DTS, Inc. in the United States and/or other countries. © DTS, Inc. All Rights Reserved.

All other trademark(s), copyright(s), and registered technologies mentioned(s) in this document are the properties of their respective owner(s).

Table of Contents

Introduction	9
Features	9
Package Contents	9
Panel Description	10
Installation	11
RS-232 Connections	11
IR Connections	12
Connection Instructions	14
Connection Diagram	15
Configuration	16
Accessing Decoders in AMS	16
Configuring a Static IP Address	19
Basic Operation	20
LED Indicators	20
Rebooting OmniStream	20
ID Button	21
Broadcast Messaging	21
Reset to Factory-Default Settings	21
Unicast Mode	22
Multicast Mode	24
Slate / Logo Insertion	27
Text Insertion	30
Fast Switching	32
Advanced Operation	34
AES67 Audio	34
IR Control	35
Downstream IR Control	35
Upstream IR Control	36
Scrambling	37
Standard Method	37
Using the Virtual Matrix	38
Creating Video Walls	39
Landscape Mode	39
Portrait Mode	44
Bezel Compensation	50
Video Walls using Velocity	52
Creating Presets	59
Creating and Using Drop Zones	64
Custom Drop Zones	72
The AMS Interface	75
Device Info page	75
IP Input page	78
HDMI Output page	80
Serial page	84
Network page	86
Other page	88
Logo	88
Text	89
PTP	90
SAP	91
The Virtual Matrix	92
Layout and Operation	93

Web Server	95
Accessing the Web Server	95
Getting the IP Address	95
Logging In	96
System information page	98
SAP page	100
IP Input page	101
Serial page	102
HDMI Output page	104
Logo page	108
Text page	110
Network page	112
PTP page	114
LLDP page	115
Configuration page	116
Users page	117
License page	118
Upgrade page	119
Appendix	120
Updating the Firmware using Velocity™/AMS	120
Updating the Firmware using the Web Server	123
Mounting Instructions	124
Rack Tray for OmniStream	125
Specifications	126

Introduction

The Atlona **OmniStream™ 521 (AT-OMNI-521)** is a networked AV decoder for an OmniStream-encoded video stream up to UHD @ 60 Hz and HDR, plus embedded audio and RS-232 or IR control pass-through. It is part of the **OmniStream R-Type Series**, designed for high performance, flexible distribution of AV over Gigabit Ethernet in residential and commercial applications. The OmniStream 521 is HDCP 2.2 compliant and ideal for the latest as well as emerging UHD and HDR displays. It features visually lossless compression, optimized for motion video, pristine-quality imaging, and extremely low, sub-frame latency from encode to decode – critical for demanding applications such as gaming. This decoder includes an HDMI output, high performance upscaling and downscaling, aspect ratio control, and video wall processing, plus presentation enhancement features such as logo insertion and scrolling on-screen text

Features

- AV decoder for HDMI® up to 4K/UHD, plus embedded audio and RS-232 or IR control pass-through
- Supports UHD @ 60 Hz plus HDR formats
- High performance, visually lossless video compression
- Pristine-quality downscaling and upscaling
- Simplify integration with plug-and-play network switch compatibility
- Remotely powered via PoE (Power over Ethernet)
- Video wall processing
- Enhance AV presentations with visual enhancements

Package Contents

- 1 x AT-OMNI-521
- 1 x Push spring connector, 6-pin
- 1 x Wall/table mounting brackets
- 4 x Rubber feet
- 1 x Installation Guide

Panel Description

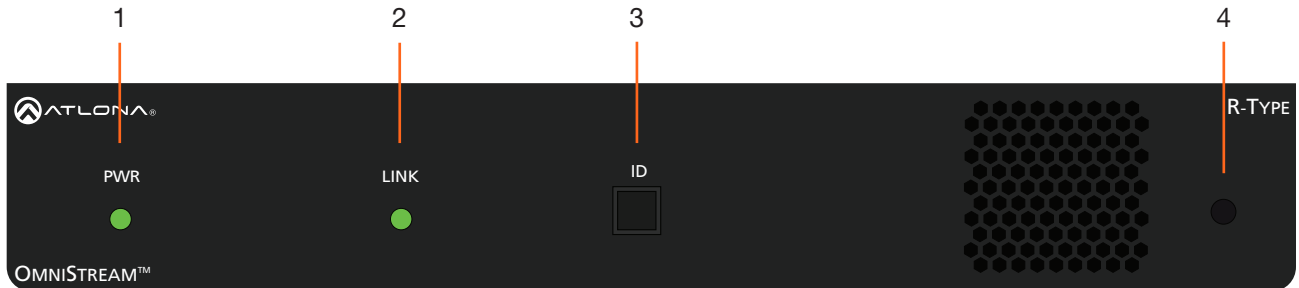

Front

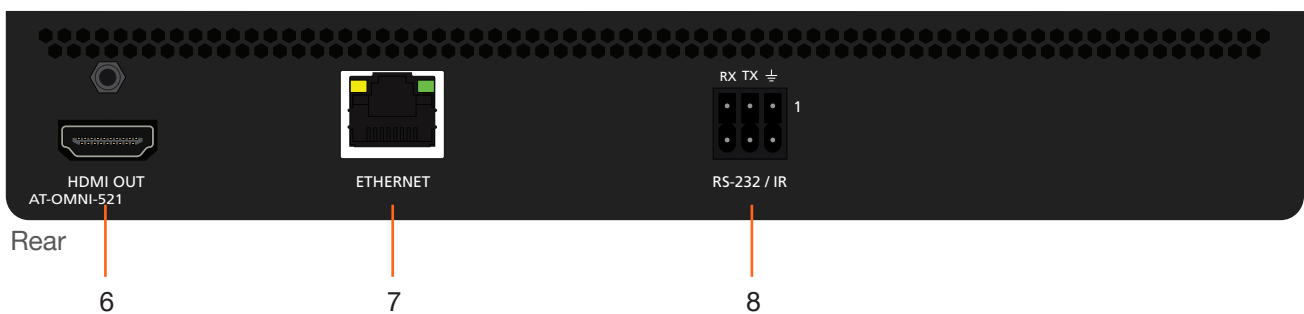

Rear

- | | |
|--|---|
| <p>1 PWR
This LED indicator is green when the unit is powered and booted.</p> <p>2 LINK
This LED indicator is green when the link integrity between the decoder and the network switch is good.</p> <p>3 ID
Press this button to send a broadcast message to any network devices that are listening. This button is also used to set the decoder to factory-default settings. Refer to ID Button (page 21) for more information.</p> <p>NOTE: Some older hardware revisions do not have an ID button.</p> | <p>4 Reboot button
Press this button, using a small, pointed object to reboot the unit.</p> <p>5 HDMI OUT
Connect an HDMI cable from this port to a UHD/HD display.</p> <p>6 ETHERNET
Connect an Ethernet cable from this port to the Local Area Network (LAN).</p> <p>7 RS-232 / IR
Connect the included 6-pin push spring block to connect an automation system and an IR emitter or extender. RS-232 Connections (page 11) for more information.</p> |
|--|---|

Installation

RS-232 Connections

The AT-OMNI-521 provides RS-232 over IP which allows communication between an automation system and an RS-232 device. This step is optional. Either the top three or bottom three set of terminals can be used for RS-232.

1. Use wire strippers to remove a portion of the cable jacket.
2. Remove at least 3/16" (5 mm) from the insulation of the RX, TX, and GND wires.
3. Insert the TX, RX, and GND wires into correct terminal on the included push-spring block. If using non-tinned stranded wire, press the orange tab, above the terminal, while inserting the exposed wire. Repeat this step for the TX, RX, and GND connections.

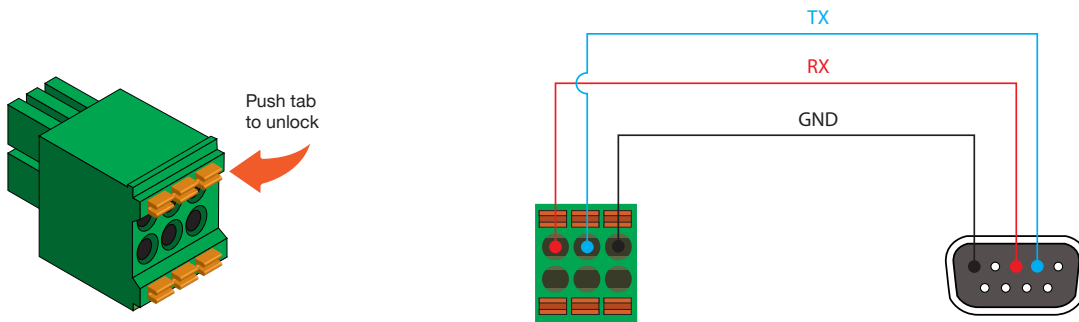

NOTE: Typical DB9 connectors use pin 2 for TX, pin 3 for RX, and pin 5 for ground. On some devices, pins 2 and 3 are reversed.

IR Connections

The same port that provides RS-232 connections also supports bidirectional IR pass-through, allowing a device to be controlled from either the headend or the decoder endpoint. This step is optional. Either the top three or bottom three set of terminals can be used for IR. Only the **RS-232 2** port (bottom set of connectors) supports both RS-232 and IR. Therefore, this port must be used for IR connections.

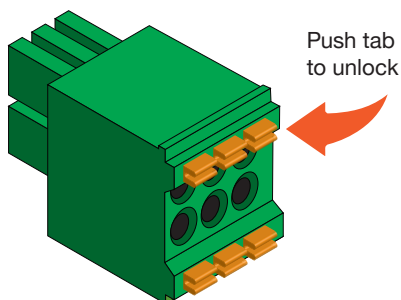

IR emitter configuration

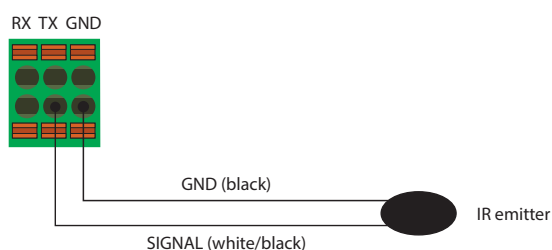

IR extender configuration

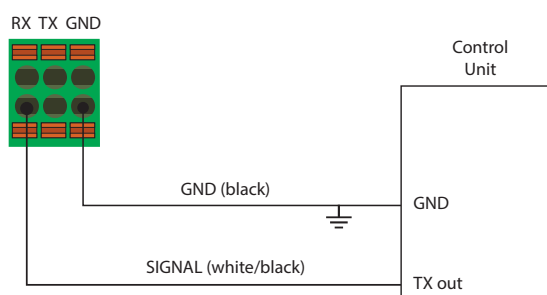

The following components are required. Note that other components may also be used. However, Atlona has tested and verified the following components for this application:

- Xantech CB12 1 Zone Connecting Block
- Xantech 12 V PSU
- Atlona AT-IR-CS-RX
- Atlona AT-OMNI-IR-TX

Decoder

1. Connect the SIGNAL, GROUND, and POWER leads from the Xantech CB12 to the AT-IR-SC-RX.
2. On the Xantech CB12, connect the SIGNAL and GROUND leads to the **RX** and \perp pins, respectively, of the **RS-232 2** port.
3. Connect the Xantech 12 V power supply (or other compatible 12 V DC power supply) to the Xantech CB12.

Encoder

4. Connect the SIGNAL and GROUND pins, from the AT-OMNI-IR-TX, to the **TX** and \perp pins, respectively, of the RS-232 2 port.
5. Refer to the illustration on the next page to verify that the correct connections have been made.

For downstream IR control, either multicast or unicast mode can be used. However, when controlling a source from the decoder (viewing location), unicast mode should be used. Refer to [Unicast Mode \(page 22\)](#) and [Multicast Mode \(page 24\)](#) for more information. Refer to [IR Control \(page 35\)](#) for information on IR configuration within AMS.

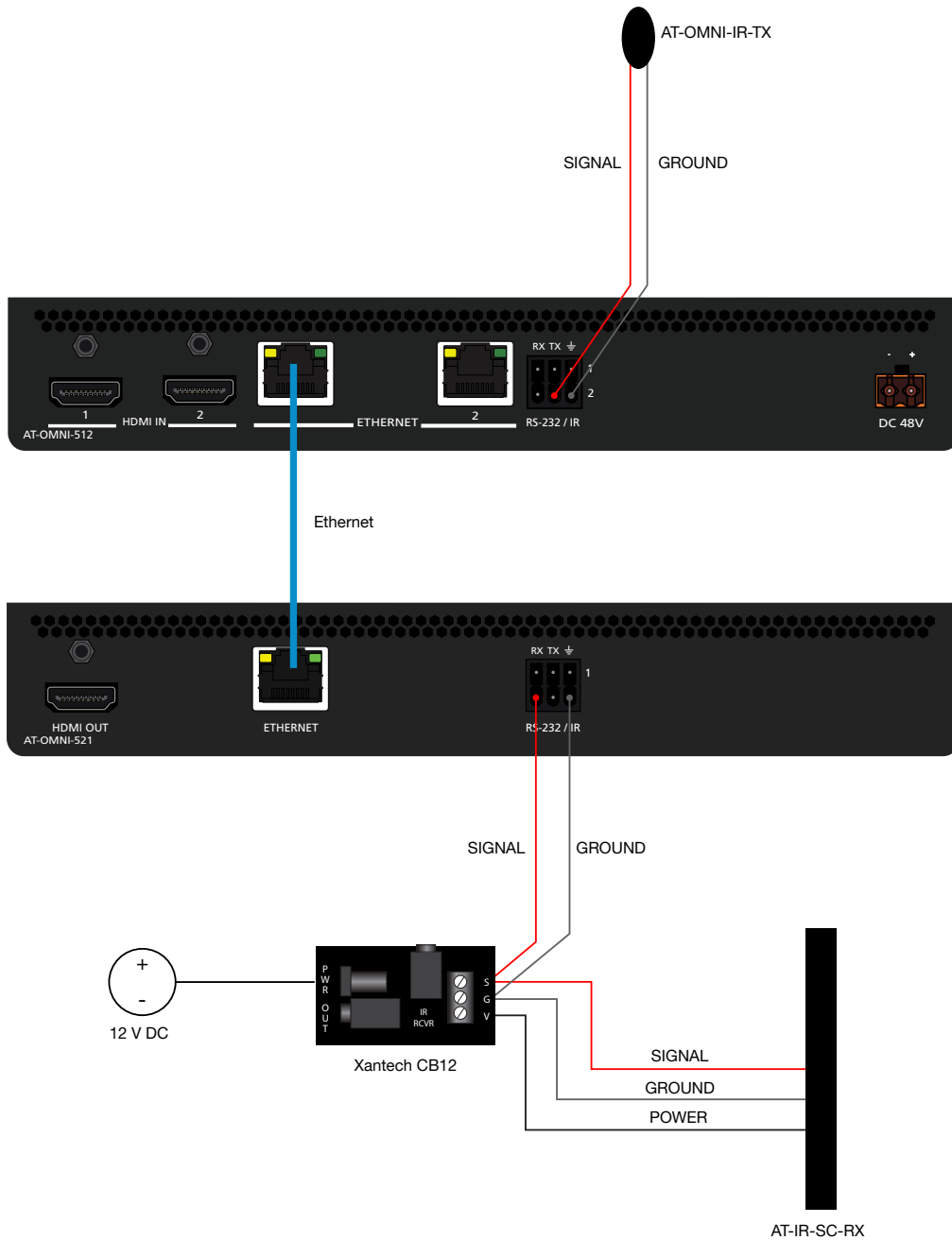

IMPORTANT: The IR emitter must be placed no more than 1” from the IR sensor on the device, in order to function properly.

Connection Instructions

1. Connect an Ethernet cable from the **ETHERNET** port on the decoder to a PoE-capable switch on the Local Area Network (LAN).



IMPORTANT: If a PoE-capable switch is not available, a PoE injector (purchased separately) must be used.

2. Connect an HDMI cable from the **HDMI OUT** port to a UHD/HD display.
3. RS-232 (optional)
 - Connect the RS-232 controller/automation system to the **RS-232** port on the decoder.
 - Connect the RS-232 device to the **RS-232** port on the decoder.

4. IR (optional)



NOTE: The IR emitter or IR receiver must always be connected to the **RS-232 2** port. Refer to [IR Control \(page 35\)](#) for more information.

- **IR emitter**
Connect the IR emitter to the **TX** and **GND** pins of the **RS-232 2** port. The IR emitter must be placed no more than one inch from the IR sensor on the device, in order to function properly.
 - **IR extender**
Connect the IR extender from the **RX** and **GND** pins of the **RS-232 2** port to the associated pins on the control system.
5. Once the unit is powered, the **PWR** indicator, on the front panel, will turn red, then amber, then green.

Connection Diagram

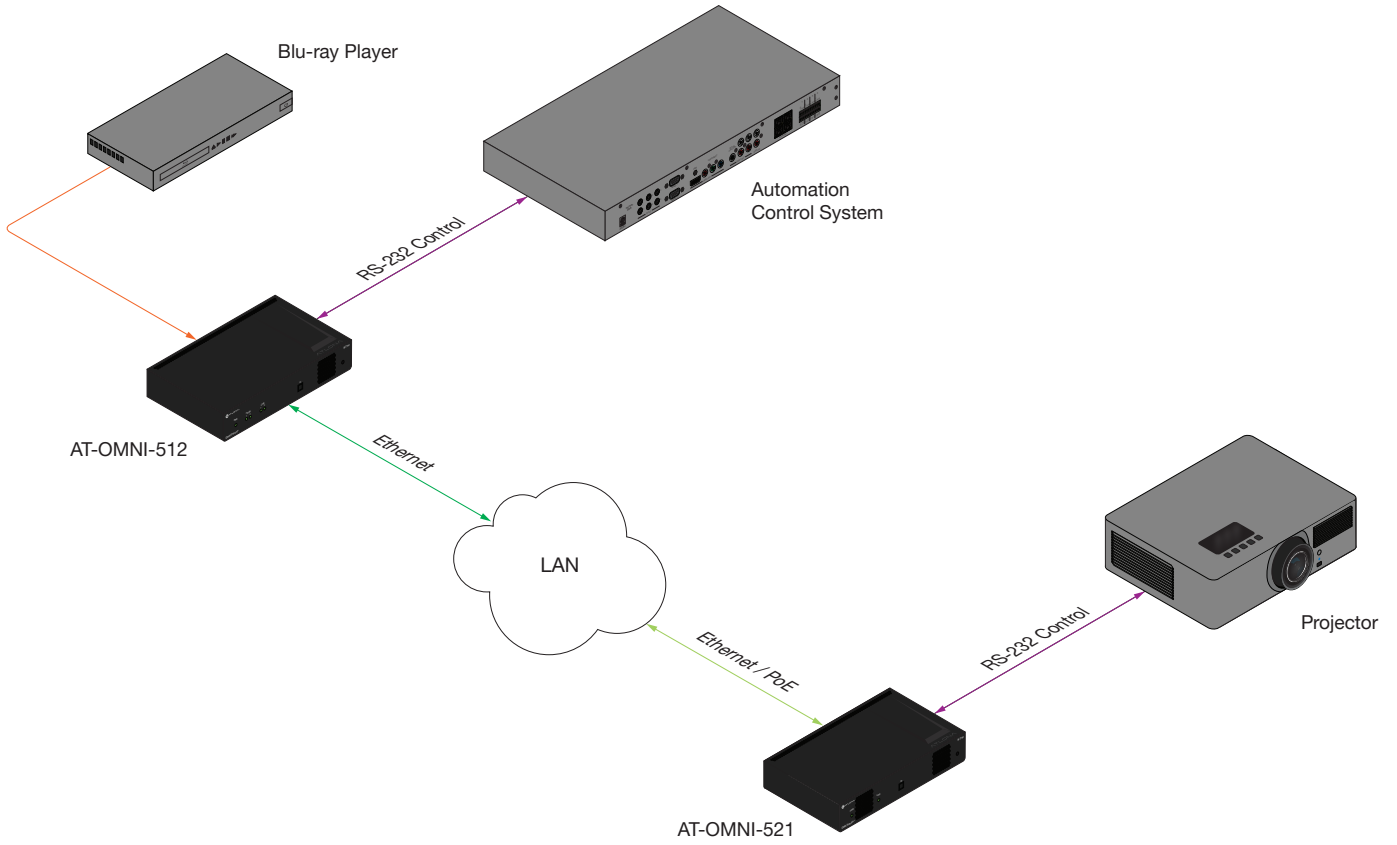

Configuration

Accessing Decoders in AMS

It is recommended that the Atlona Management System (AMS) be used to configure and control OmniStream devices. AMS uses multicast Domain Name Server (mDNS) to automatically discover each encoder on the network. AMS is free and can be downloaded from <https://www.atlona.com/ams>.

By default, the AT-OMNI-521 is set to DHCP mode, allowing a DHCP server (if present) to assign the encoder an IP address. Once an IP address has been assigned, the Atlona Management System (AMS) can be used to manage the product on the network. Note that AMS will only be able to discover encoders if they are on the same VLAN.

In order for AMS to automatically assign multicast IP addresses to OmniStream decoders, the destination IP addresses for the session streams must be cleared.

1. Launch a web browser and enter the IP address of AMS, in the address bar.
2. Enter the required login credentials. The default login is:

Username: admin
Password: Atlona

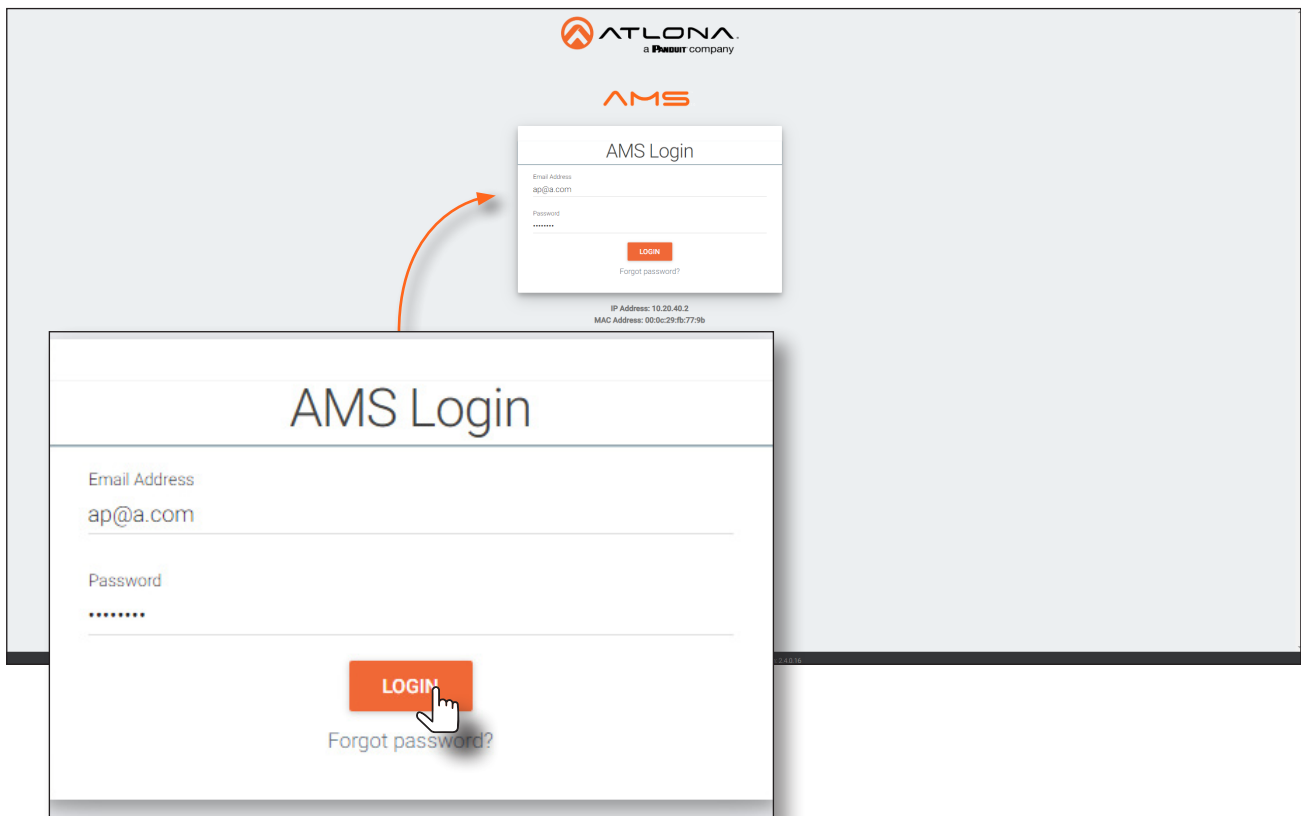

3. Click the **Login** button.
4. The AMS Dashboard will be displayed.
5. Click the  icon, in the upper-left corner of the AMS Dashboard.

6. Click **Devices** from the fly-out menu.

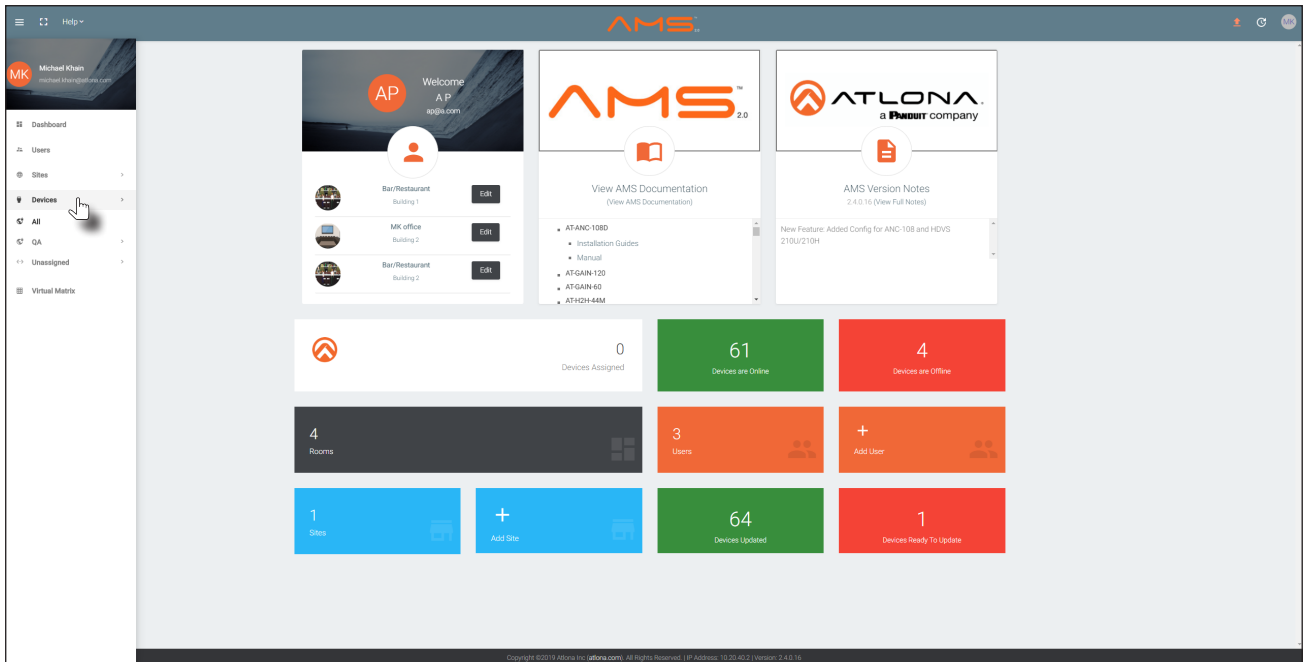

7. Click the **Unassigned** option.

8. Click the left and right arrows, at the bottom of the **Unassigned** list, to scroll through all available devices.

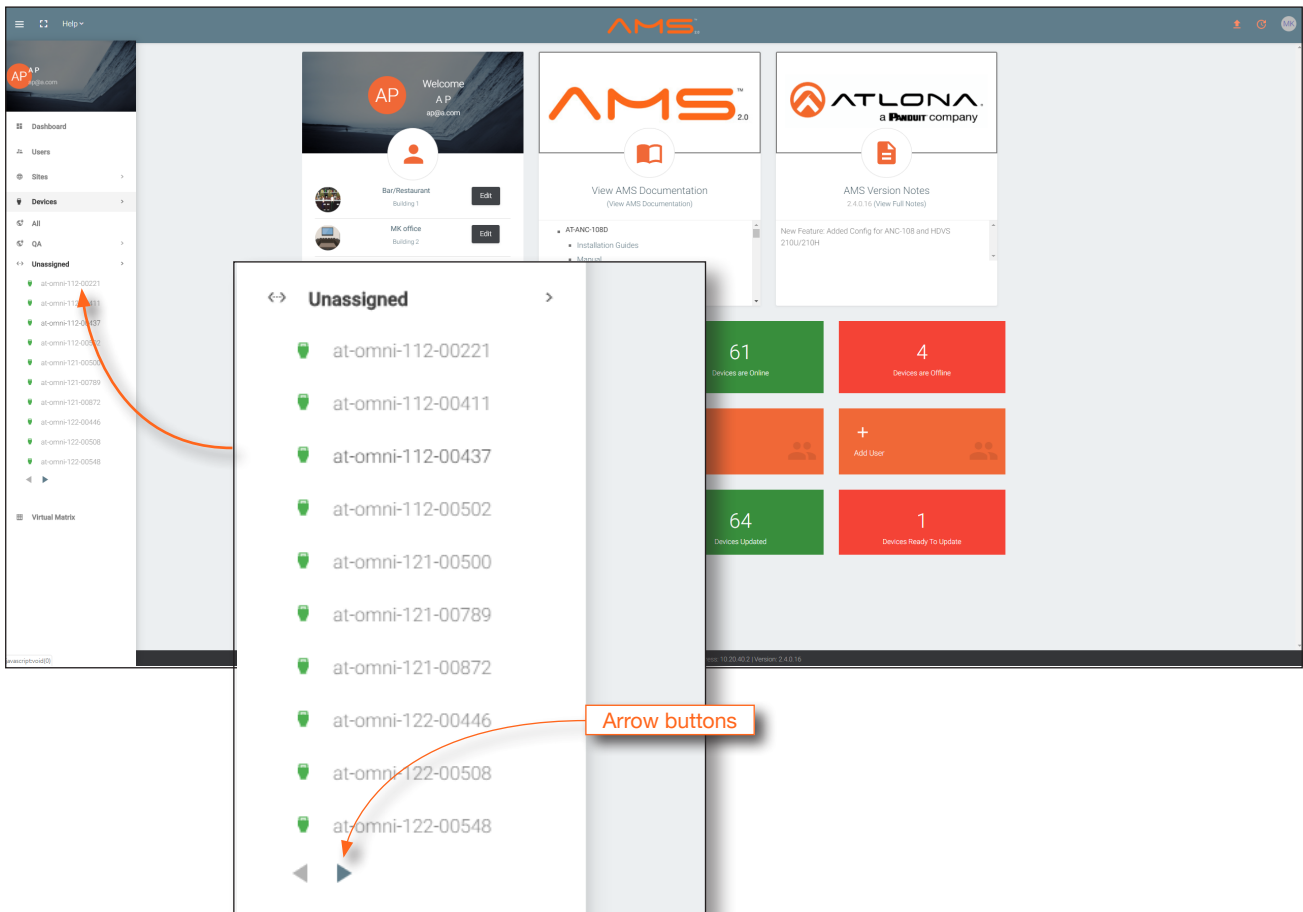

All available decoders will be displayed under the **Unassigned** category. When a decoder is unassigned, it means that it has not been assigned to a site, building, and/or room. Refer to the AMS User Manual for more information on these topics.

If a DHCP server is not found within 60 seconds, the encoder will be placed in Auto IP mode and assigned an IP address within the range of 169.254.xxx.xxx. If this occurs, configure the network interface of the computer that is running AMS, located on the same subnet (169.254.xxx.xxx, subnet mask 255.255.0.0). Refer to [Configuring a Static IP Address \(page 19\)](#) for more information on configuring the AT-OMNI-521 in Auto IP mode.

If no AT-OMNI-512 is found, then verify the following:

- The computer that is running AMS must be on the same network as the OmniStream device.
- Remove any network restrictions that may be in place. In order for mDNS to function properly, there

must not be restrictions applied to the network.

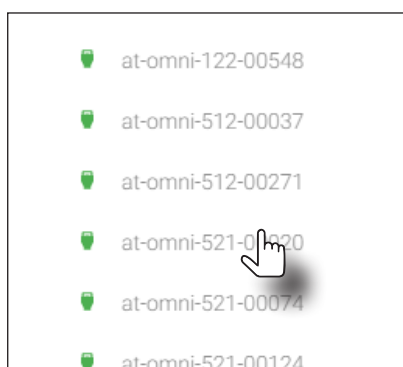

9. Click the desired decoder within the **Unassigned** list.

10. Once the unit is selected, the control interface for the encoder will be displayed. The illustration below shows the **DEVICE INFO** screen for the AT-OMNI-521.

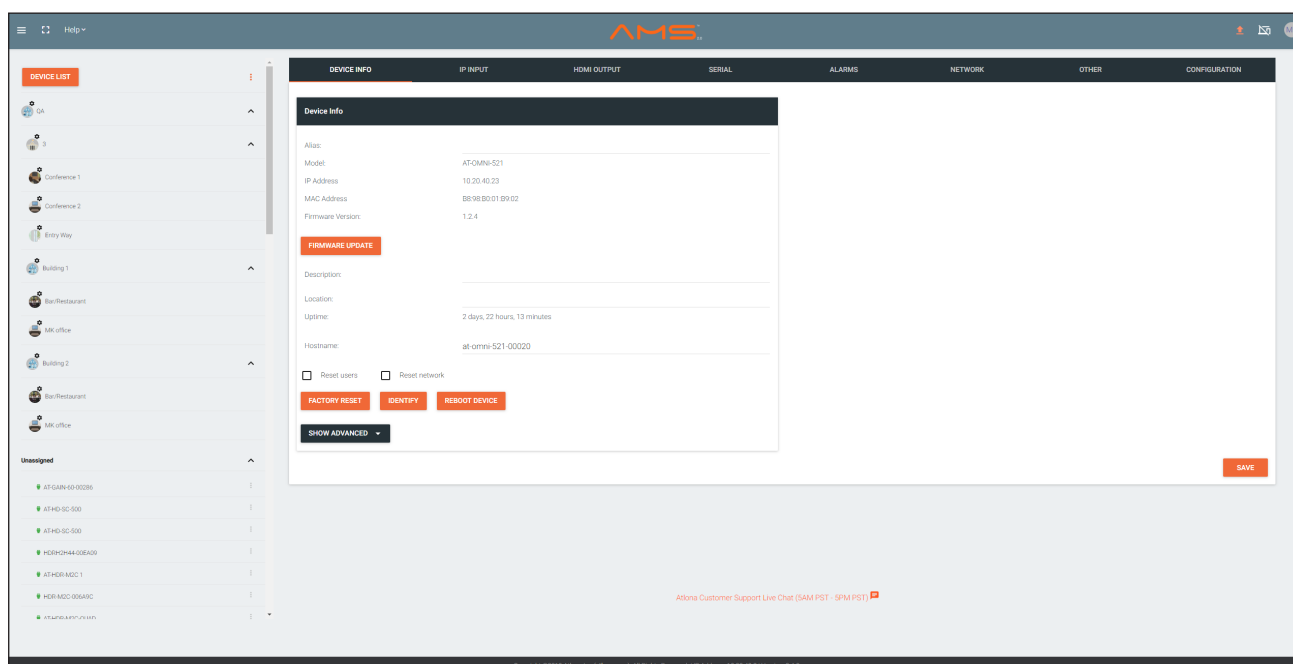

Configuring a Static IP Address

The following section is only required to set the AT-OMNI-521 decoder, currently in Auto IP mode, to a static IP address. If a DHCP server is not found within 60 seconds, decoders are automatically placed in Auto IP mode and will be assigned an IP address within the range 169.254.xxx.xxx. If this occurs, a static IP address can be assigned to the decoder in order for AMS to locate it on the network.

1. Make sure that the AT-OMNI-521 is powered. Power is supplied by connecting an Ethernet cable from the **ETHERNET** port on the decoder to a PoE-capable switch. If a PoE switch is not being used, then a PoE injector (not included) will need to be used.
2. Connect an Ethernet cable from the PC directly to one of the Ethernet ports on the switch. Make sure that the computer being used has AMS installed.
3. Configure the PC to a static IP address that is on the same subnet as the decoder.



IMPORTANT: Before continuing, write down the current IP settings in order to restore them, later. If *Obtain an IP address automatically* and *Obtain DNS server automatically* are selected, then this step is not required.

4. Login to AMS. Refer to [Accessing Decoders in AMS \(page 16\)](#) for information on the login process.
5. Locate the AT-OMNI-521 decoder under the **Unassigned** section within AMS.
6. Click on the device.
7. Under AMS, click **NETWORK** in the menu bar.

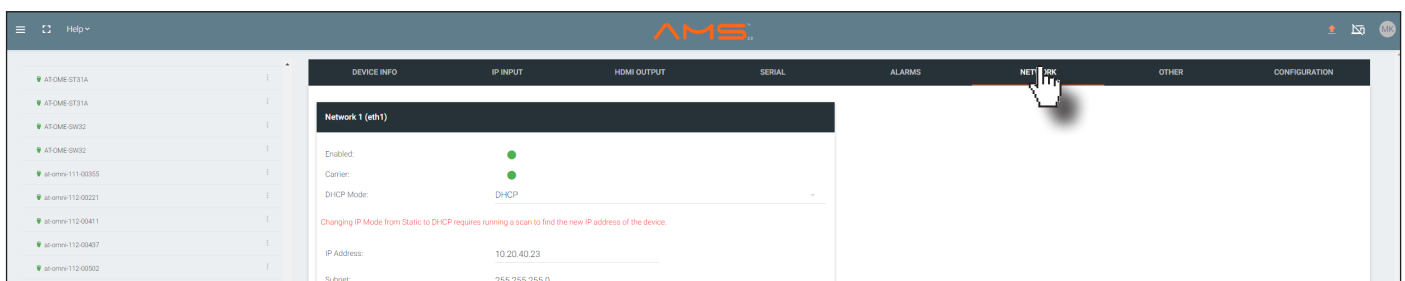

8. Click the **DHCP Mode** drop-down list and select **Static**.



9. Enter the required network information for the decoder in the **IP Address**, **Subnet**, and **Gateway** fields.
10. Click the **Save** button in the bottom-right corner, to apply the changes.
11. Disconnect the decoder from the PC and connect it to the network.
12. The decoder is now ready for use.

Basic Operation

LED Indicators

The following table provides a listing of front-panel LED indicators and their status:

LED		Description
PWR	Off ○	Unit is powered off. <ul style="list-style-type: none"> If using a PoE switch, make sure that the port on the switch that is connected to the decoder, has PoE enabled. When the decoder is powered using PoE, the PWR indicator will be green. Check the Ethernet cable for possible damage or loose connections. If a PoE switch is not being used, then a PoE injector (not included) will need to be connected to the decoder.
	Red ●	The decoder is booting.
	Green ●	The decoder is ready.
LINK	Red ●	<ul style="list-style-type: none"> The decoder is powered, but no Ethernet cables are connected between the switch and the ETHERNET port. Check the Ethernet cable for possible damage or loose connections.
	Green ●	Link integrity is good between the decoder and the network.

Rebooting OmniStream

To reboot the OmniStream decoder, press and release the recessed button, on the far-right side of the unit, using a small, pointed object. Rebooting the decoder does not reset the decoder to factory-default settings.

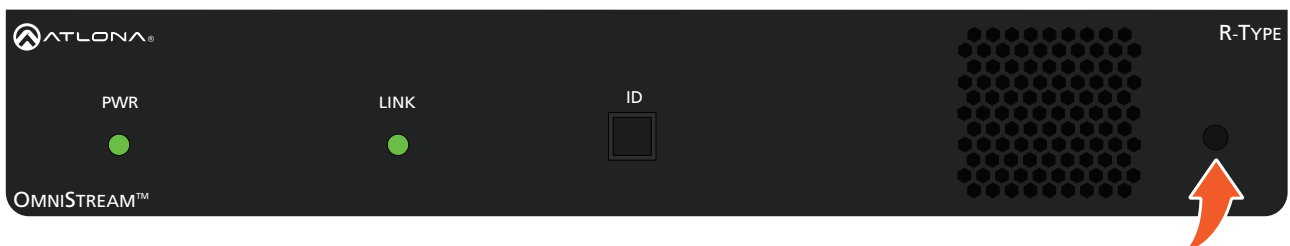

ID Button

The **ID** button serves two functions:

1. Sends a broadcast message over the network to any devices that may be listening.
2. Resets the encoder to factory-default settings.



NOTE: Some older hardware revisions do not have an **ID** button.

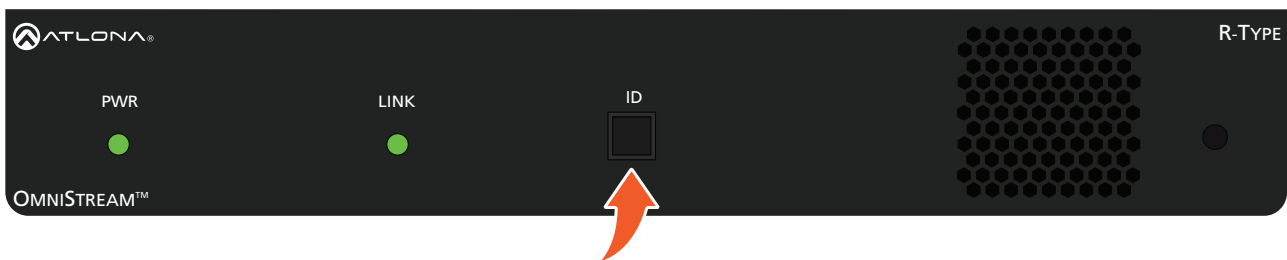

Broadcast Messaging

Press and release the **ID** button to send a broadcast notification over the network to any devices that may be listening.

Reset to Factory-Default Settings



WARNING: Performing a factory-default reset will erase all user-programmed settings from the encoder. IP settings are not preserved.

Using the ID button

1. Press and hold the **ID** button for approximately 30 seconds.
2. The LED indicators on the front panel will flash, then turn “off.”
3. The encoder is now reset and will need to be reconfigured.

Using the Mclear command

1. Connect a PC to serial port 1 using a USB to serial cable.
2. Set the PC console port to the following settings: 9600 baud, 8 data bits, 1 stop bit, no parity.
3. Once connected to the CLI, execute the `Mclear` command.

Using the Web Server

1. Log in to the encoder using the built-in web server. Refer to [Logging In \(page 96\)](#) for more information. Note that OmniStream devices communicate using both LLDP and CDP protocols. Consult the switch documentation for information on returning neighbor details from the CLI. Neighbor details will include the IP address of the decoder.
2. Click the **Reset Defaults** checkbox and click the **FACTORY RESET** button.
3. The decoder is now reset and will need to be reconfigured.

Unicast Mode

The term *unicast* is used to describe a configuration where information is sent from an encoder to a single decoder. Although it is common to have multiple encoder and decoder units within a system, it may also be desirable to restrict a single encoder to communicate with one decoder. In *unicast* mode, OmniStream encoders and decoders function similar to an n x 1 switcher. Changing the destination IP address at the encoder, will direct the stream to be received by a different decoder.

The illustration below shows three encoders and three decoders on a network, operating in *unicast* mode. The red lines indicate the data paths from each encoder to a separate (single) decoder.



NOTE: By default, both encoders and decoders are shipped in multicast mode.

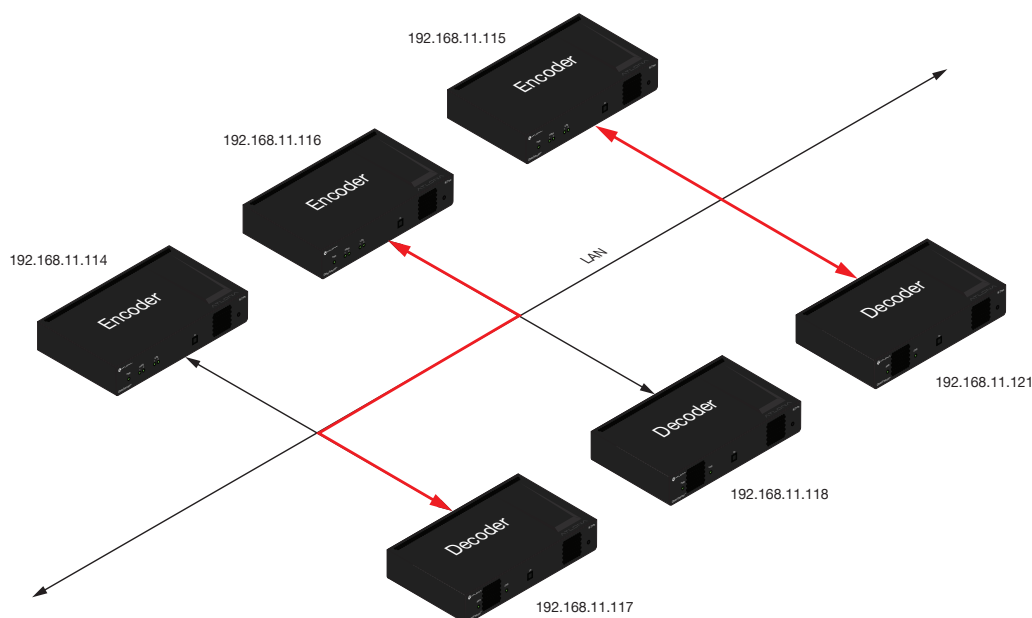

1. Login to AMS. Refer to [Accessing Decoders in AMS \(page 16\)](#) if necessary.
2. Go to the encoder AMS interface. Refer to the *OmniStream Single-Channel / Dual Channel A/V Encoder User Manual*, if necessary.
3. Click **SESSION** in the menu bar and locate the **Video** section.
4. Enter the IP address of the decoder in the **Destination Multicast/Unicast Address** field. If using dual-channel encoders, repeat this process for each stream.

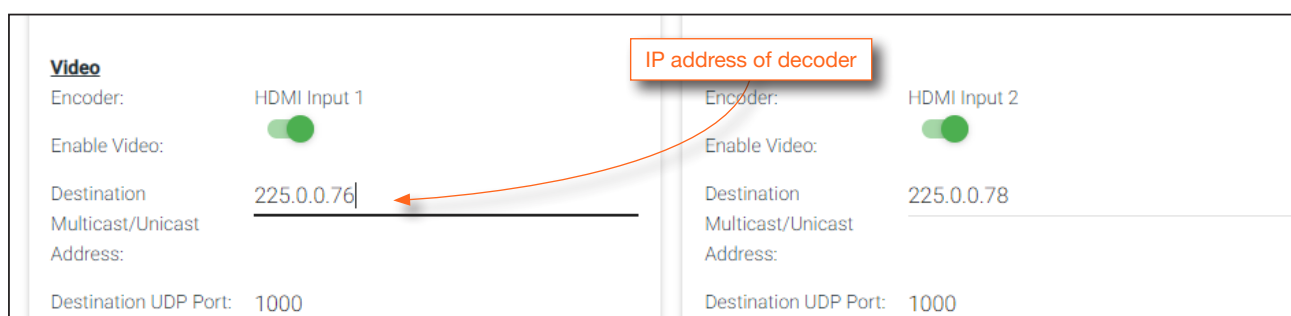

5. Scroll down to the bottom of the page and click the **SAVE** button to commit all changes.

6. Go to the decoder AMS interface.
7. Click **IP INPUT** from the menu.
8. Remove the IP address from the **Multicast Address** field.
9. Click the **SAVE** button to commit changes.

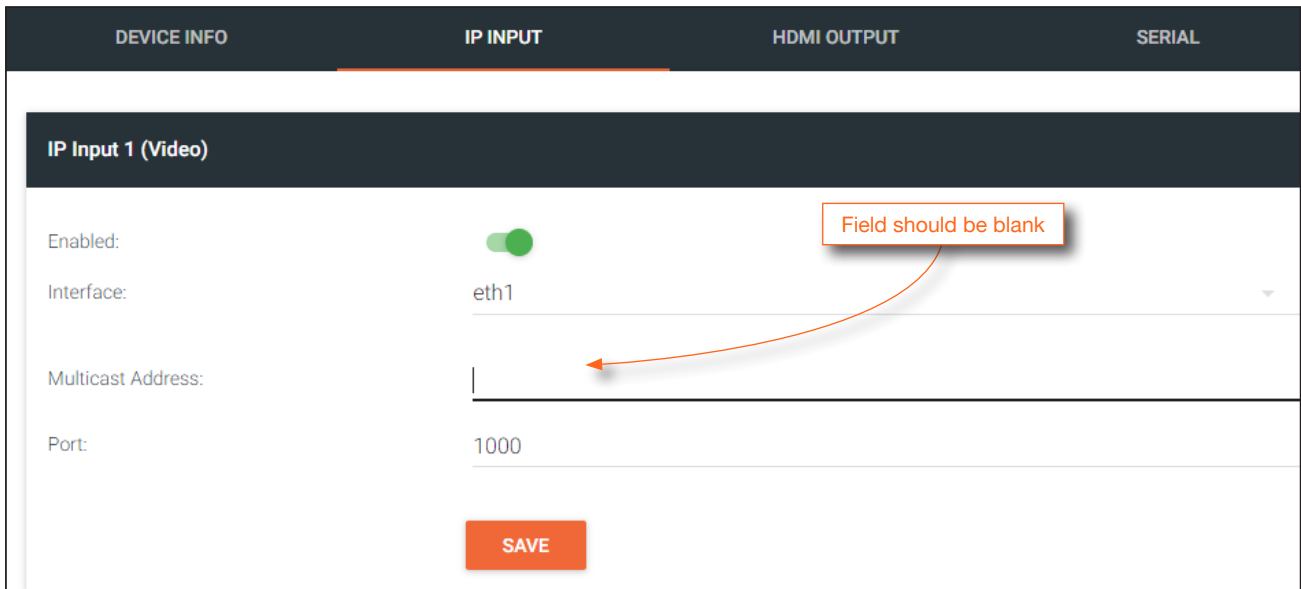

The screenshot shows the configuration page for 'IP Input 1 (Video)'. It includes a navigation bar with 'DEVICE INFO', 'IP INPUT', 'HDMI OUTPUT', and 'SERIAL'. The 'IP INPUT' tab is selected. The configuration fields are: 'Enabled' (checked), 'Interface' (eth1), 'Multicast Address' (empty), and 'Port' (1000). A red callout box with the text 'Field should be blank' points to the empty 'Multicast Address' field. A red 'SAVE' button is located at the bottom of the configuration area.

10. Unicast setup is complete. The decoder unit will now receive streams exclusively from the encoder containing the IP address of this decoder.

Multicast Mode

The term *multicast* is used to describe a configuration where information is sent from one or more points to a set of other points. For example, a single encoder can transmit data to multiple decoders. In addition, if multiple encoders are used, each encoder can stream data to any decoder that is not already receiving data from an encoder. In *multicast* mode, the OmniStream encoders and decoders function similar to a matrix switcher.

The illustration below shows three encoders and three decoders on a network, operating in *multicast* mode, where multiple decoders are subscribed to a single encoder. The red lines indicate the data paths from an encoder (192.168.11.117) to multiple decoders.



NOTE: By default, both encoders and decoders are shipped in multicast mode.

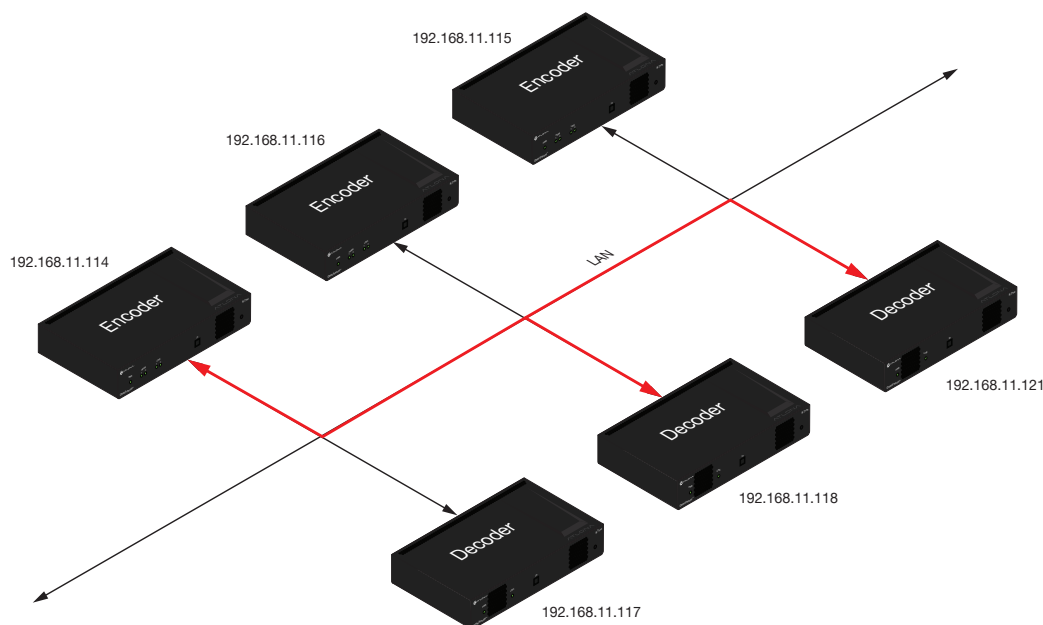

1. Login to AMS. Refer to [Accessing Decoders in AMS \(page 16\)](#), if necessary.
2. The AMS Dashboard will be displayed.
3. Click the  icon, in the upper-left corner of the AMS Dashboard.
4. Click **Virtual Matrix** from the fly-out menu. Refer to [The Virtual Matrix \(page 92\)](#), if necessary.
5. Locate the desired encoder in the Virtual Matrix, as shown on the next page.
6. Create a cross-connection to the desired decoder. When a cross-connection is created, AMS will automatically assign a multicast IP address to both the encoder and decoder. By default, AMS automatically assigns a multicast IP address to each OmniStream encoder and decoder.

Refer to the illustration on the following page, if necessary.

Encoders / Decoders		OmniStream Virtual Matrix										
LEGEND		Andrew's AT-OMNI-122 192.168.11.181 at-omni-122-00548 Connected	Connected	AT-OMNI-121 192.168.11.34 at-omni-121-00461 Options	Connected	AT-OMNI-122 192.168.11.86 192.168.11.87 at-omni-122-00242 Options	Connected	AT-OMNI-521 192.168.11.39 at-omni-521-00064 Options	Connected	AT-OMNI-122 192.168.11.160 192.168.11.161 at-omni-122-00381 Options	Connected	Andrew's AT-OMNI-111 192.168.11.166 at-omni-111-00722 Disconnected
Video	View: Active	HDMI 1	HDMI 2	HDMI 1	HDMI 1	HDMI 2	HDMI 1	HDMI 1	HDMI 2	HDMI 1	HDMI 2	HDMI 1
AT-OMNI-112 192.168.11.89 192.168.11.88 at-omni-112-00349 Connected	HDMI 1	Matrix Icon	Matrix Icon	Matrix Icon	Matrix Icon	Matrix Icon	Matrix Icon	Matrix Icon	Matrix Icon	Matrix Icon	Matrix Icon	Matrix Icon
AT-OMNI-111 192.168.11.50 at-omni-111-00200 Connected	HDMI 1	Matrix Icon	Matrix Icon	Matrix Icon	Matrix Icon	Matrix Icon	Matrix Icon	Matrix Icon	Matrix Icon	Matrix Icon	Matrix Icon	Matrix Icon
AT-OMNI-512 192.168.11.51 at-omni-512-00003 Connected	HDMI 1	Matrix Icon	Matrix Icon	Matrix Icon	Matrix Icon	Matrix Icon	Matrix Icon	Matrix Icon	Matrix Icon	Matrix Icon	Matrix Icon	Matrix Icon
Andrew's AT-OMNI-112 192.168.11.116 at-omni-112-00722 Disconnected	HDMI 1	Matrix Icon	Matrix Icon	Matrix Icon	Matrix Icon	Matrix Icon	Matrix Icon	Matrix Icon	Matrix Icon	Matrix Icon	Matrix Icon	Matrix Icon
AT-OMNI-112 192.168.11.183 192.168.11.148 at-omni-112-00335 Disconnected	HDMI 1	Matrix Icon	Matrix Icon	Matrix Icon	Matrix Icon	Matrix Icon	Matrix Icon	Matrix Icon	Matrix Icon	Matrix Icon	Matrix Icon	Matrix Icon
Andrew's AT-OMNI-111 192.168.11.167 at-omni-111-00355 Connected	HDMI 1	Matrix Icon	Matrix Icon	Matrix Icon	Matrix Icon	Matrix Icon	Matrix Icon	Matrix Icon	Matrix Icon	Matrix Icon	Matrix Icon	Matrix Icon
AT-OMNI-512 192.168.11.31 at-omni-512-00037 Connected	HDMI 1	Matrix Icon	Matrix Icon	Matrix Icon	Matrix Icon	Matrix Icon	Matrix Icon	Matrix Icon	Matrix Icon	Matrix Icon	Matrix Icon	Matrix Icon
	HDMI 2	Matrix Icon	Matrix Icon	Matrix Icon	Matrix Icon	Matrix Icon	Matrix Icon	Matrix Icon	Matrix Icon	Matrix Icon	Matrix Icon	Matrix Icon

at-omni-111-00355 Connected	HDMI 1	Matrix Icon	Matrix Icon
AT-OMNI-512 192.168.11.31	HDMI 1	Matrix Icon	Matrix Icon
at-omni-512-00037 Connected	HDMI 2	Matrix Icon	Matrix Icon

5. Enter the desired scrambling key using one of the following methods:

- Manual enter a user-defined key in the **Key** field.

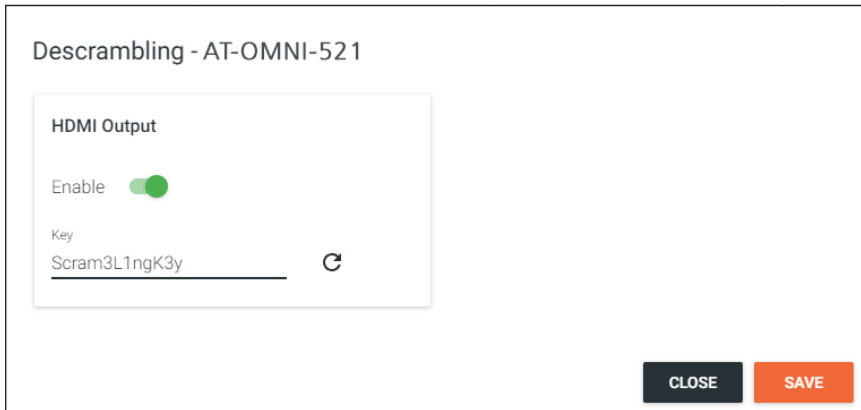

Descrambling - AT-OMNI-521

HDMI Output

Enable

Key
Scram3L1ngK3y 

CLOSE SAVE

- Click the  icon to generate a random key using AMS. Each time this icon is clicked, a new scrambling key will be generated.

6. Repeat the above process for each session.
7. Click the **Save** button to commit the changes.

Slate / Logo Insertion

IMPORTANT: Slate / logo insertion is not supported when fast switching is enabled. Refer to [Fast Switching \(page 32\)](#) for more information on enabling and disabling fast switching.

Slate / logo insertion is managed from within AMS. The difference between a “slate” and “logo” is in the size of the image and how it is used: Logos are classified as smaller, low-resolution images that can be positioned at specified locations on the screen. Slates occupy the entire screen. Note that while logos may be used as slates, the image quality will be degraded, as the image will be scaled to fill the screen.

Slate / logo insertion can be performed on both the encoder and decoder. When configured on the encoder, the image that is displayed will be from the encoder IP address(es) to which each decoder is subscribed. When configured on the decoder, the presence of the image is specified on the (individual) HDMI output. Refer to the *OmniStream Single-Channel / Dual Channel A/V Encoder User Manual*, for information on managing slate / logo insertion on encoder units.

IMPORTANT: When using 4K images, the image width must not exceed 30% of the horizontal resolution.

1. Login to AMS. Refer to [Accessing Decoders in AMS \(page 16\)](#) if necessary.
2. Click **OTHER** in the menu bar.
3. Verify that **Logo** is selected, near the upper-left corner of the screen. **Logo** is the default selection and applies to both logo and slate images.
4. Enter the name of the image in the **Name** field. If a name is not specified, then the **UPLOAD** button will be disabled.
5. Under the **New logo** window group, click the **Choose File** button and select the image to be used. Only .png files are valid selections.
6. Click the **UPLOAD** button to upload the file.

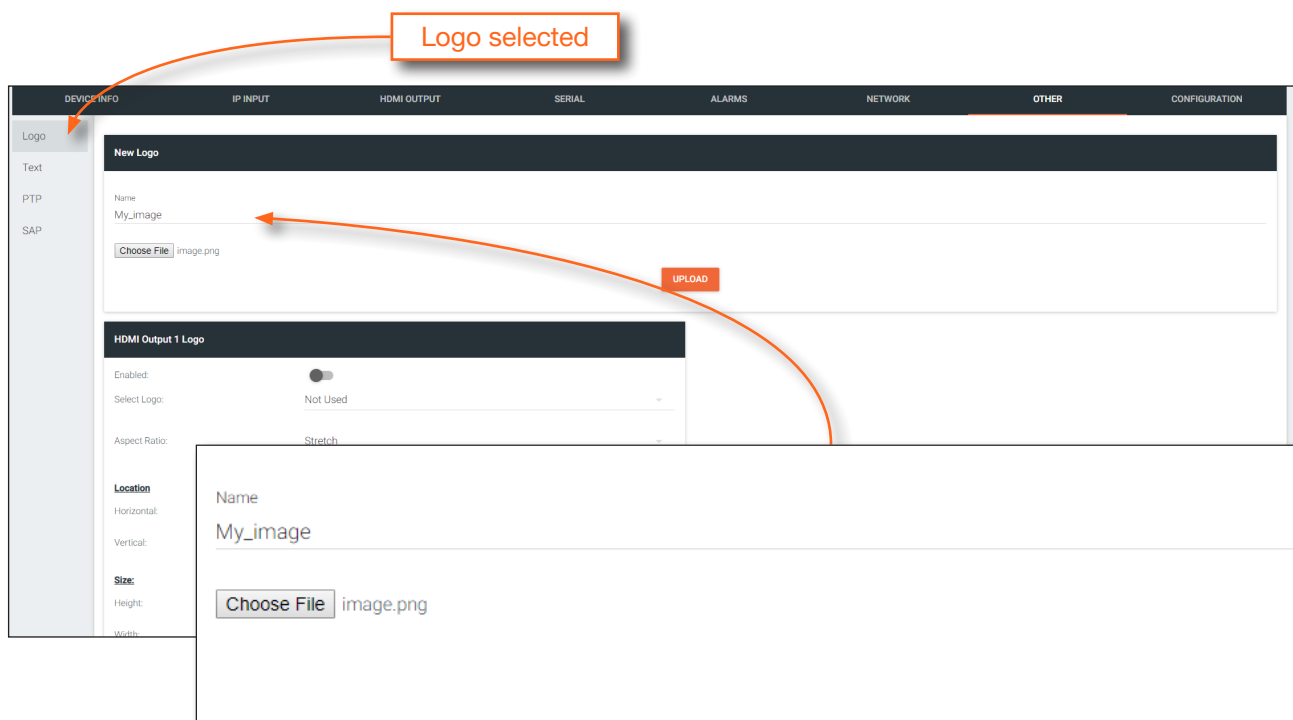

7. A new window group will be created with the name of the logo that was provided in Step 4.

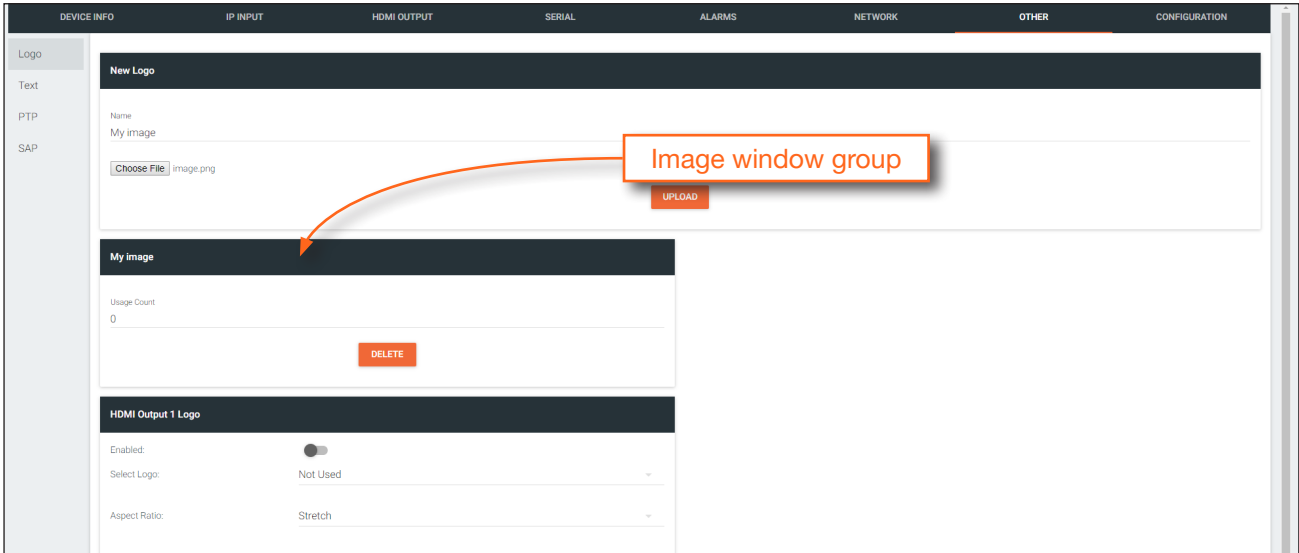

8. Perform one of the following:

- If the selected image will be used as a *logo*, then proceed with Steps 9 through 13.
- If the image will be used as a *slate*, skip to Step 14.

9. Under the **HDMI Output Logo** window group, click the **Select Logo** drop-down list and select the desired logo. To prevent the image from being displayed, select the **Not used** option.

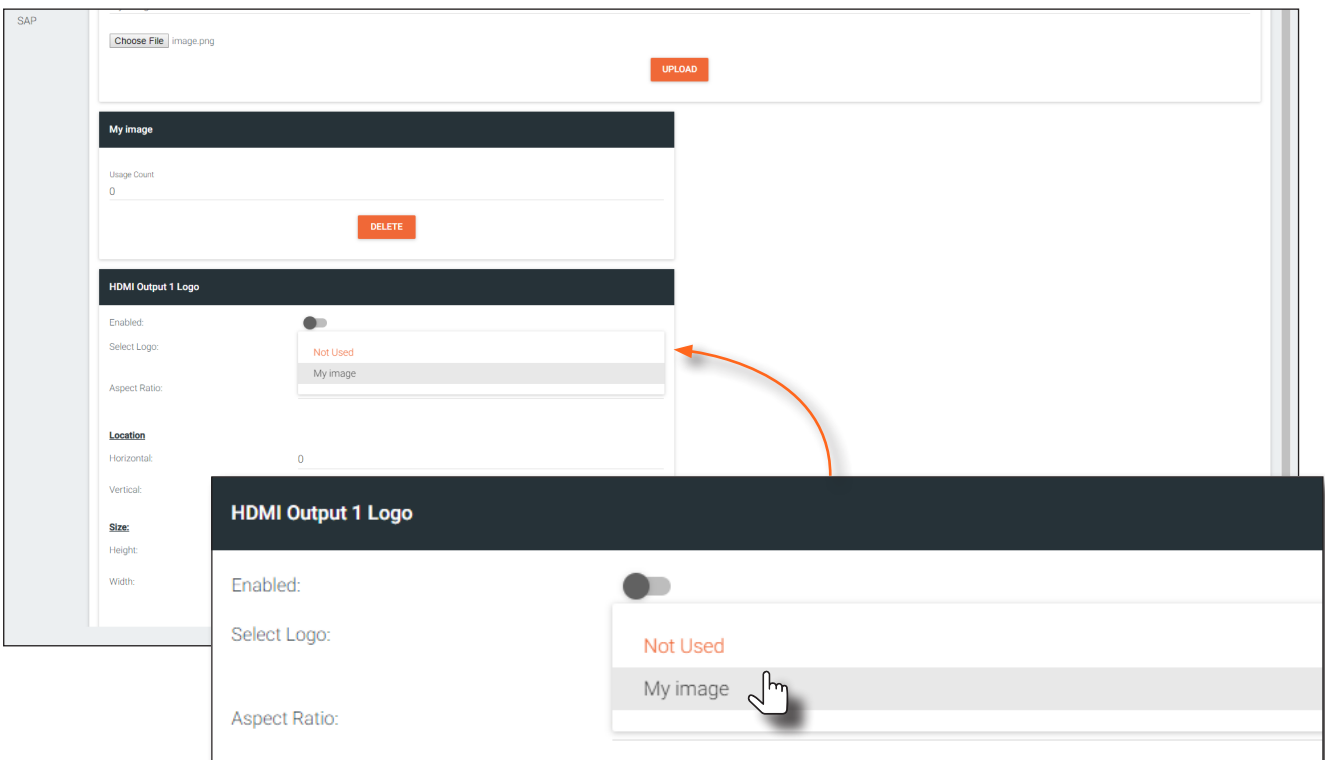

10. Click the **Aspect Ratio** drop-down list to set the aspect ratio of the image. Selecting **Keep** will maintain the aspect ratio. Select **Stretch** to scale the image to fill the screen.
11. Enter the location of the on-screen image, in pixel values, by entering the desired values in the **Horizontal** and **Vertical** fields.
12. Click the **Enabled** toggle switch to activate the logo/slate feature. When enabled, this toggle switch will be green.
13. Click the **SAVE** button to commit changes.
14. Click **HDMI OUTPUT** in the menu bar, then click the **SHOW ADVANCED** button.
15. Click the **Slate mode** drop-down list, and select **Off**, **Manual**, or **Auto**.

Mode	Description
Off	Disables the image from being displayed.
Manual	The image will always be displayed, superimposed on the source signal, and will remain even if the source signal is lost.
Auto	The image will only be displayed when the source signal is lost. For example, this mode is useful in conference room applications for displaying system instructions when no sources are connected.

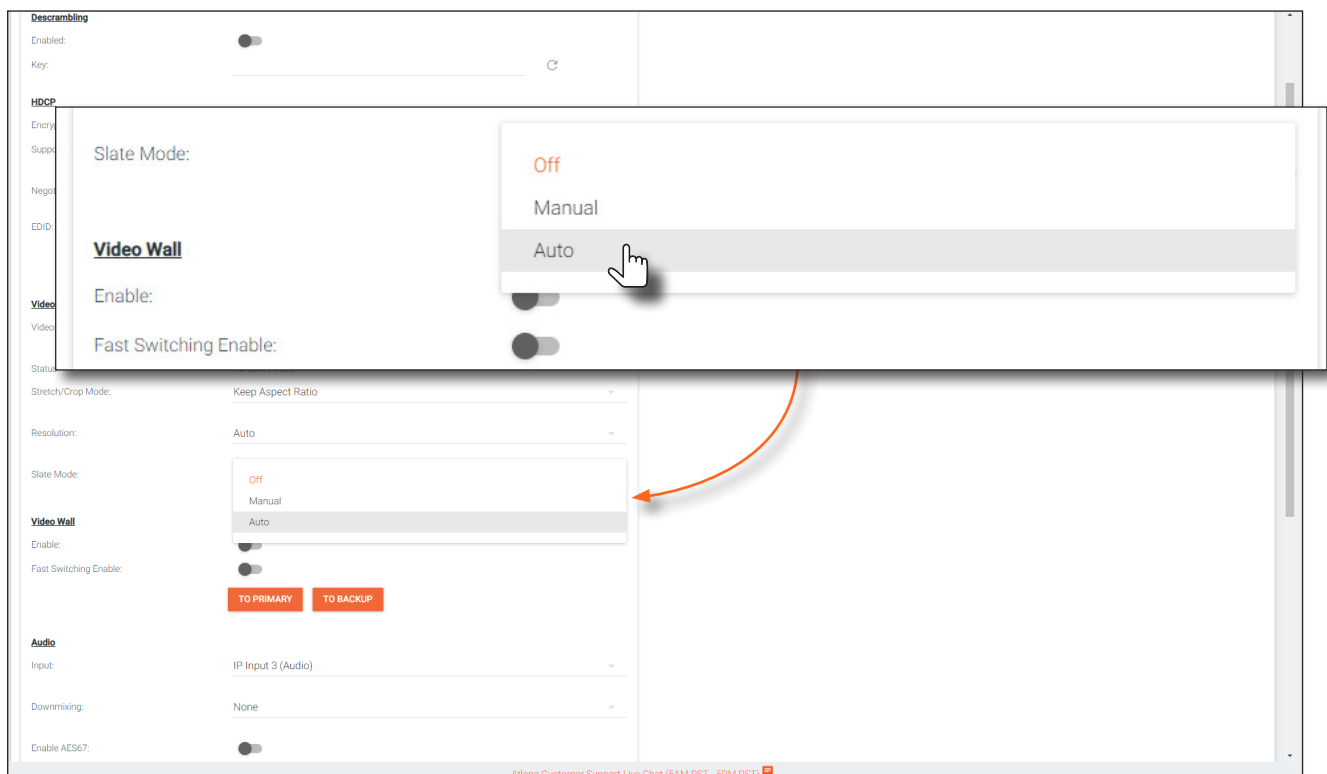

16. Click the **Slate Logo** drop-down list and select the desired image. Note that if **Slate Mode** is set to **Off**, then this field will not be visible.
17. Click the **SAVE** button to apply all changes.

Text Insertion

Text can be inserted and scrolled across the screen, making it useful for messages and notifications. Several options are available when using text: Scroll speed adjustment (forward, reverse, or static), number of iterations, text color, vertical / horizontal position, as well as transparency.

1. Login to AMS. Refer to [Accessing Decoders in AMS \(page 16\)](#) if necessary.
2. Click **OTHER** in the menu bar.
3. Click **Text** in the side menu bar, in the upper-left corner of the AMS screen.
4. Click the **Enabled** toggle switch, to allow the text to be displayed. When enabled, the toggle switch will be green.

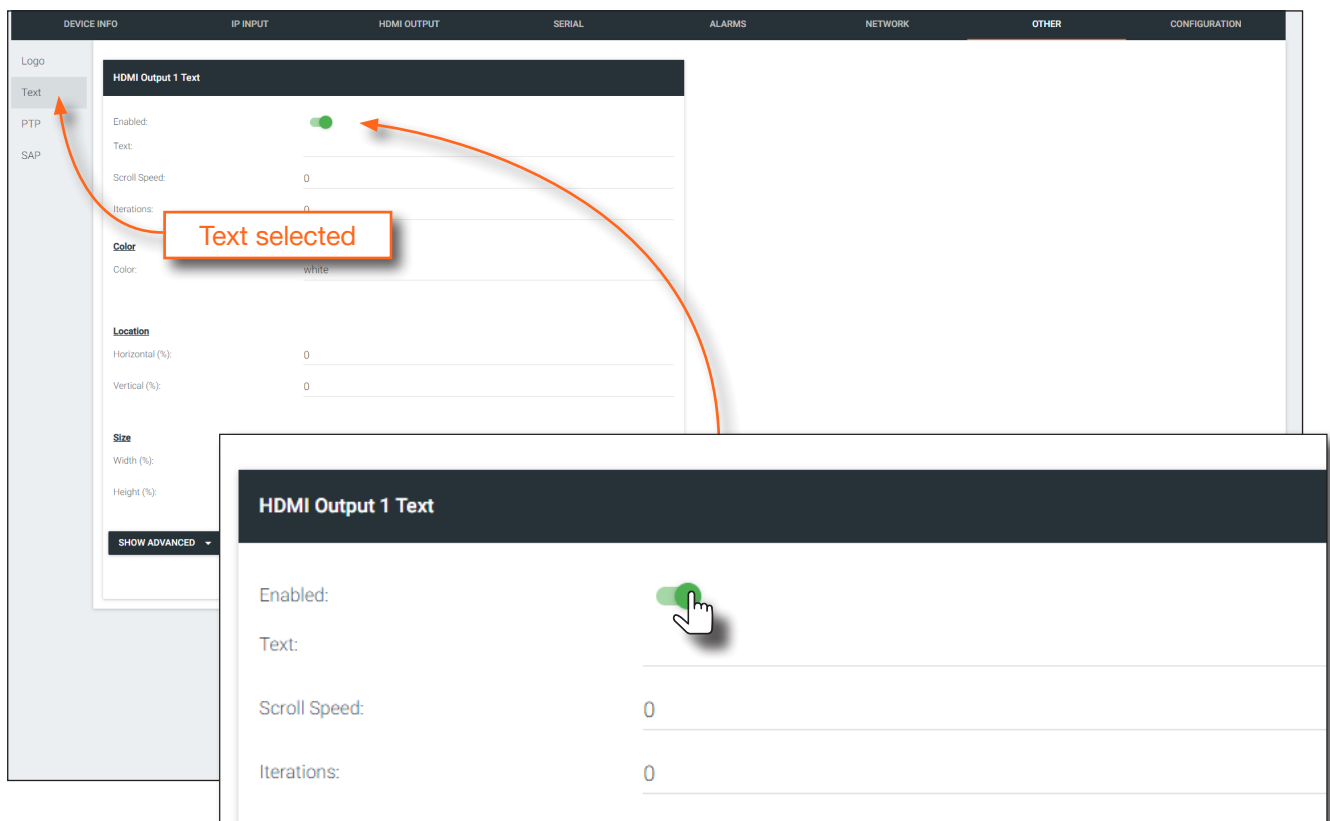

5. In the **Text** field, enter the desired text.
6. Specify the speed of the scrolling text in the **Scroll Speed** field. Values from -255 to 255 are valid. Negative numbers will scroll the text from left to right. Positive numbers will scroll text from right to left.
7. Enter the number of iterations in the **Iteration** field. Set this field to 0 (zero) to set the number of iterations to infinity.
8. Click the **Color** drop-down list to select the color of the text. The **Red**, **Green**, and **Blue** fields can be changed to further modify the color of the text. Adjust the **Alpha** field to control the transparency of the text. A value of 255 is opaque and a value of 0 is transparent. Numbers from 0 to 255 are valid for each of these fields.
9. Specify the location of the text in the **Horizontal (%)** and **Vertical (%)** fields. Each of these values is based on the horizontal and vertical resolution of the screen.

9. Specify the size of the text in the **Width (%)** and **Height (%)** fields. Each of these values is based on the horizontal and vertical resolution of the screen.
10. Click the **SAVE** button to apply all changes.

Fast Switching



IMPORTANT: If Fast Switching is enabled, latency increases from 0.5 frames to 1.5 frames. When using Fast Switching mode, the output resolution will be 1920x1080p, regardless of the source resolution. Also note that 1080i is not supported in Fast Switching mode. Also note that Slate / Logo Insertion and Text Insertion will be automatically disabled when Fast Switching is enabled.

This feature is a software implementation which vastly improves the HDMI authentication process, resulting in ultra-fast switching between video streams.

1. Login to AMS. Refer to [Accessing Decoders in AMS \(page 16\)](#) if necessary.
2. Click **HDMI OUTPUT** in the menu bar.
3. Click the **Fast Switching Enable** toggle switch. By default, this feature is disabled and the toggle switch will be gray. Click the toggle switch to enable fast switching. When enabled, the toggle switch will be green.

Video	
Video:	IP Input 1 (Video 1)
Input Status:	No active video
Active Input:	Video 1
Output Status:	No active video
HDR:	<input type="checkbox"/>
Stretch/Crop Mode:	Keep Aspect Ratio
Resolution:	Input
Framerate:	Auto
Fast Switching Enable:	<input checked="" type="checkbox"/>
Fast Switching Timeout (s):	5

4. Enter the timeout interval in the **Fast Switching Timeout (s)** field. When fast switching is enabled, and if the decoder is switched to a different stream, but the stream is not present, then the decoder will hold the last image on the screen, until either a new stream appears or the decoder is switched to a different stream. Once the timeout interval has expired, the screen will go black. Setting the timeout interval to 0 disables this feature and the last image will be displayed indefinitely. The timeout interval is in seconds.
5. Set the output resolution and frame rate in the **Resolution** and **Framerate** fields. The following table provides maximum timing, color space, and bit-depth specifications when fast switching is enabled.

Number of Channels	Resolution	Framerate	Color Space	Bit Depth
1	1920 x 1200	60 Hz	4:4:4	12-bit



NOTE: When fast-switching is enabled, the output resolution at the decoder endpoint is dependent on both the number of channels on the decoder and the input resolution received from the encoder. Refer to the table below for details.

Input Resolution (from Encoder)	Output Resolution (AT-OMNI-521)
1280 x 720p	1280 x 720p
1920 x 1080p @ 60 Hz	1920 x 1080p @ 60 Hz
> 1920 x 1080p (up to UHD)	1920 x 1080p @ 60 Hz

Advanced Operation

AES67 Audio

AES67 audio is a standard for high-performance audio streaming over IP, providing several features such as synchronization, media clock identification, and connection management. AES67 does not support bitstream/compressed audio formats, such as Dolby® Digital, and others. Source audio must be transmitted as LPCM up to eight channels at 192 kHz / 24-bit.

1. Login to AMS. Refer to [Accessing Decoders in AMS \(page 16\)](#), if necessary.
2. Click **Devices** > **All** and select the desired encoder from the **Device List**.
3. Click **SESSION** in the menu bar.
4. Locate the **Audio** section, under the desired **Stream**, and click the **Enable AES67** toggle switch to enable this feature. When enabled, the toggle switch will be green.

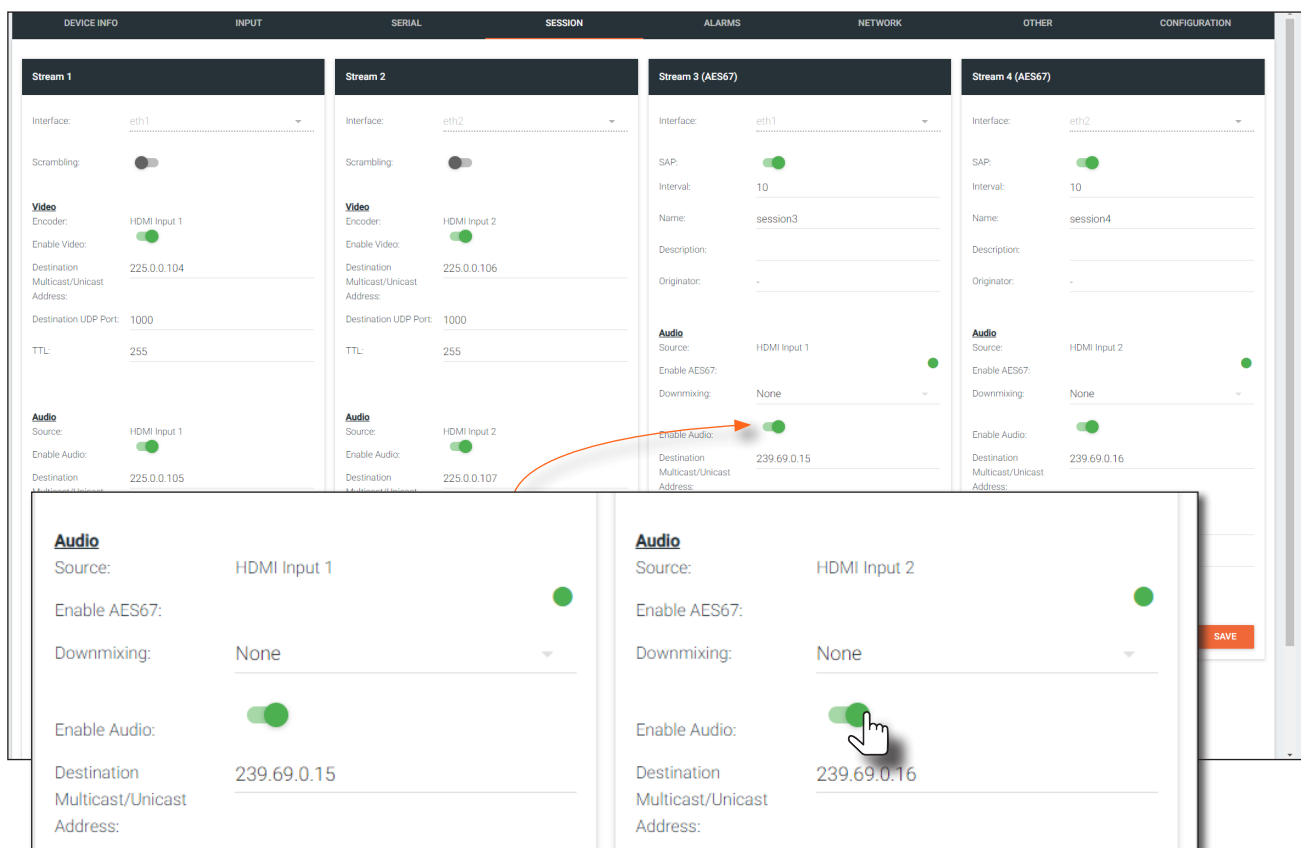

5. Select the type of downmixing from the **Downmixing** drop-down list, if desired. Available options are: **None**, **Mono**, or **Stereo**.
6. Click the **SAVE** button within the **Stream** window group.
7. Go to the decoder interface and click **OTHER** in the menu bar.
8. Click **SAP** in the upper-left corner of the screen.
9. Click the **Enable** toggle switch to enable SAP. When enabled, the toggle switch will be green. If the decoder, Dante controller, or DSP is to receive AES67 audio, this step is *required*.
10. Click the **SAVE** button on the **SAP** page.

IR Control

OmniStream provides IR control from either the headend / source location to the displays (downstream) or from the viewing location to the headend (upstream). For downstream IR control, either multicast or unicast mode can be used. However, when controlling a source from the viewing location, unicast mode should be used. Refer to [Unicast Mode \(page 22\)](#) and [Multicast Mode \(page 24\)](#) for more information.



NOTE: IR control is only supported on the **RS-232 / IR 2** (bottom) port. The IR emitter or IR receiver must be connected to this port. Refer to [IR Connections \(page 12\)](#) for wiring information.

Downstream IR Control

Follow the instructions below to configure AMS to allow IR data to be sent from the encoder to the decoder endpoint.

1. Login to AMS. Refer to [Accessing Decoders in AMS \(page 16\)](#), if necessary.
2. The AMS Dashboard will be displayed.
3. Click the  icon, in the upper-left corner of the AMS Dashboard.
4. Click **Devices** > **All** and locate the desired encoder from the AMS Device List.
5. Click **SERIAL** in the menu bar.
6. Under the **Serial Port 2** section, make sure that the **Mode** drop-down list is set **infrared**. This will be the only option for the AT-OMNI-521 under **Serial Port 2**.

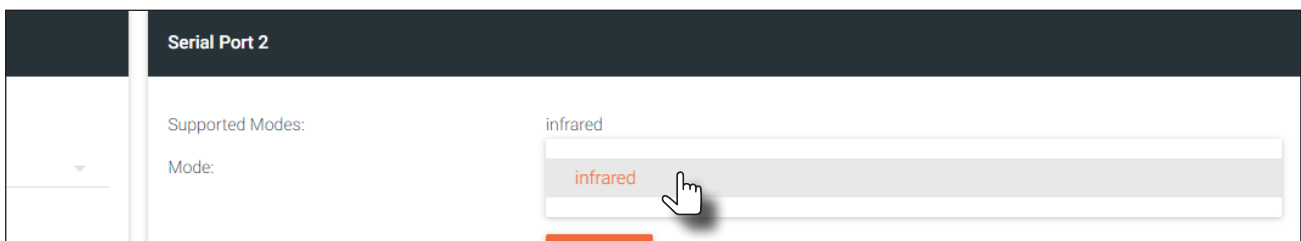

7. Scroll down and locate the **Serial Configuration 2** section and select **Serial Port 2** from the **Port** drop-down list.
8. Click the **Mode** drop-down list and select **Output**.

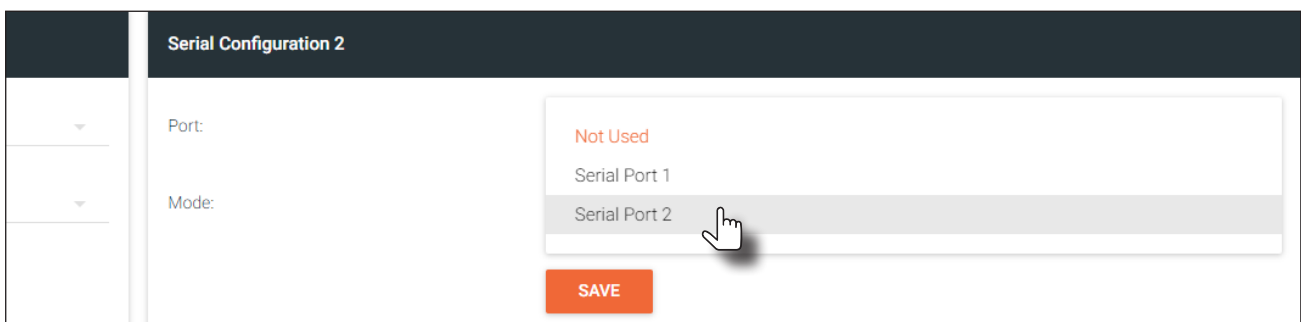

9. Click the **Input** drop-down list and select the IP input. The selected input must not be currently in use by another session. If the input is already in used, then an error message will be displayed. If this occurs, then select another input.
10. Click the **SAVE** button to commit changes. If IR signals need to be sent upstream, to the encoder, then follow the instructions under [Upstream IR Control \(page 36\)](#).

Upstream IR Control

In order to send IR data upstream, from the decoder to the encoder, a few additional simple steps are required.

1. Follow steps 1 through 9, under [Downstream IR Control \(page 35\)](#).
2. Click **IP Input** in the top menu bar.
3. Locate the **IP Input 5 (Control)** window group and enter the IP address of the encoder, in the **Multicast Address** field.
4. Enter the port number in the **Port** field.

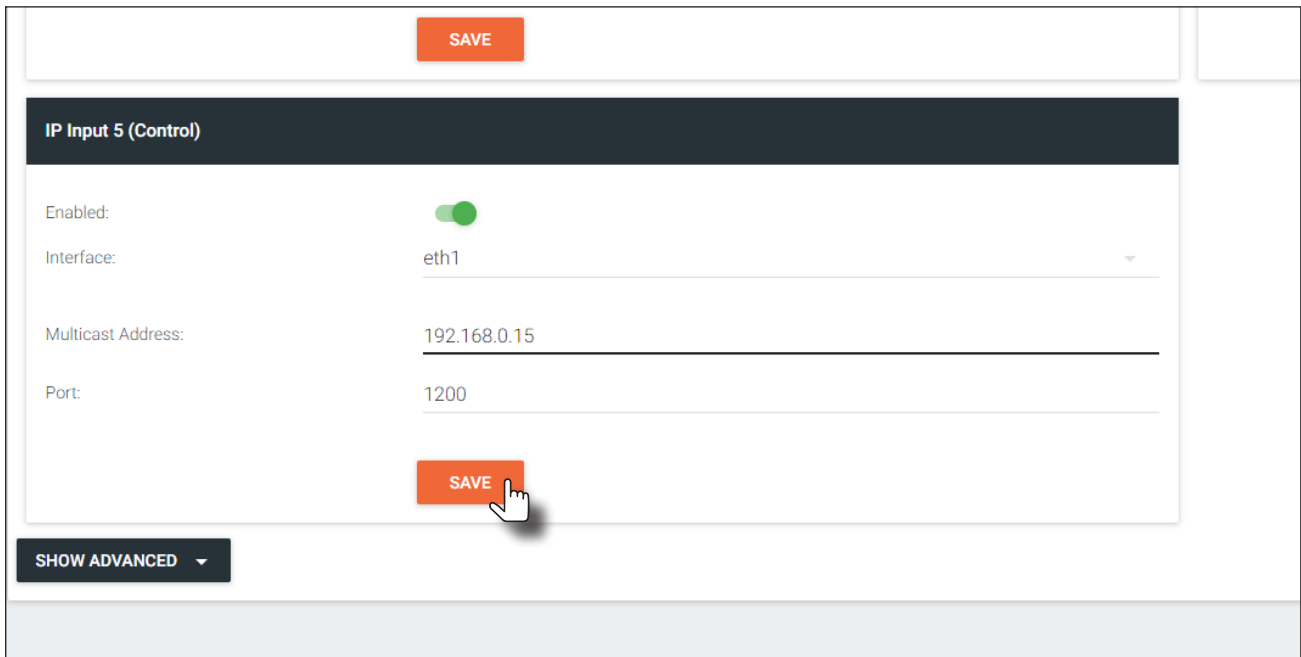

The screenshot displays the configuration interface for 'IP Input 5 (Control)'. At the top right of the configuration area is an orange 'SAVE' button. Below the title bar, the 'Enabled' toggle switch is turned on (green). The 'Interface' dropdown menu is set to 'eth1'. The 'Multicast Address' field contains '192.168.0.15' and the 'Port' field contains '1200'. At the bottom center, another orange 'SAVE' button is visible with a mouse cursor hovering over it. A 'SHOW ADVANCED' button with a dropdown arrow is located at the bottom left of the configuration area.

5. Click the **Enabled** toggle switch to enable bidirectional control. When enabled, the toggle switch will be green, and will allow IR signals to be sent to the encoder.
6. Click the **SAVE** button to commit changes.

Scrambling

OmniStream supports 128-bit Advanced Encryption Standard (AES) scrambling and is required for HDCP-encrypted streams. Scrambling can be enabled or disabled through AMS, and can be applied to individual sessions. In order for scrambling to function properly, it must be enabled on both the encoder session and all decoders subscribed to a stream that is a part of a scrambled session. The scrambling key on both encoder and subscribed decoder(s) must be identical. When enabled, the default scrambling key is “key”.

Standard Method

1. Login to AMS. Refer to [Accessing Decoders in AMS \(page 16\)](#), if necessary.
2. Click **Devices** > **All** and select the desired encoder from the **Device List**.
3. Click **HDMI OUTPUT** in the menu bar.
4. Under the desired HDMI output, click the **Enabled** toggle switch, under **Descrambling**, to enable it. When enabled, the toggle switch will be green and the **Key** field will be displayed.
5. Enter the scrambling key in the **Key** field.



IMPORTANT: In order for scrambling to function correctly, the same key that was specified on the encoder (scrambling) must be entered in the **Key** field. Also note that If a user-defined key is specified, then it must be a minimum of eight alphanumeric characters. Special characters and spaces are not permitted.

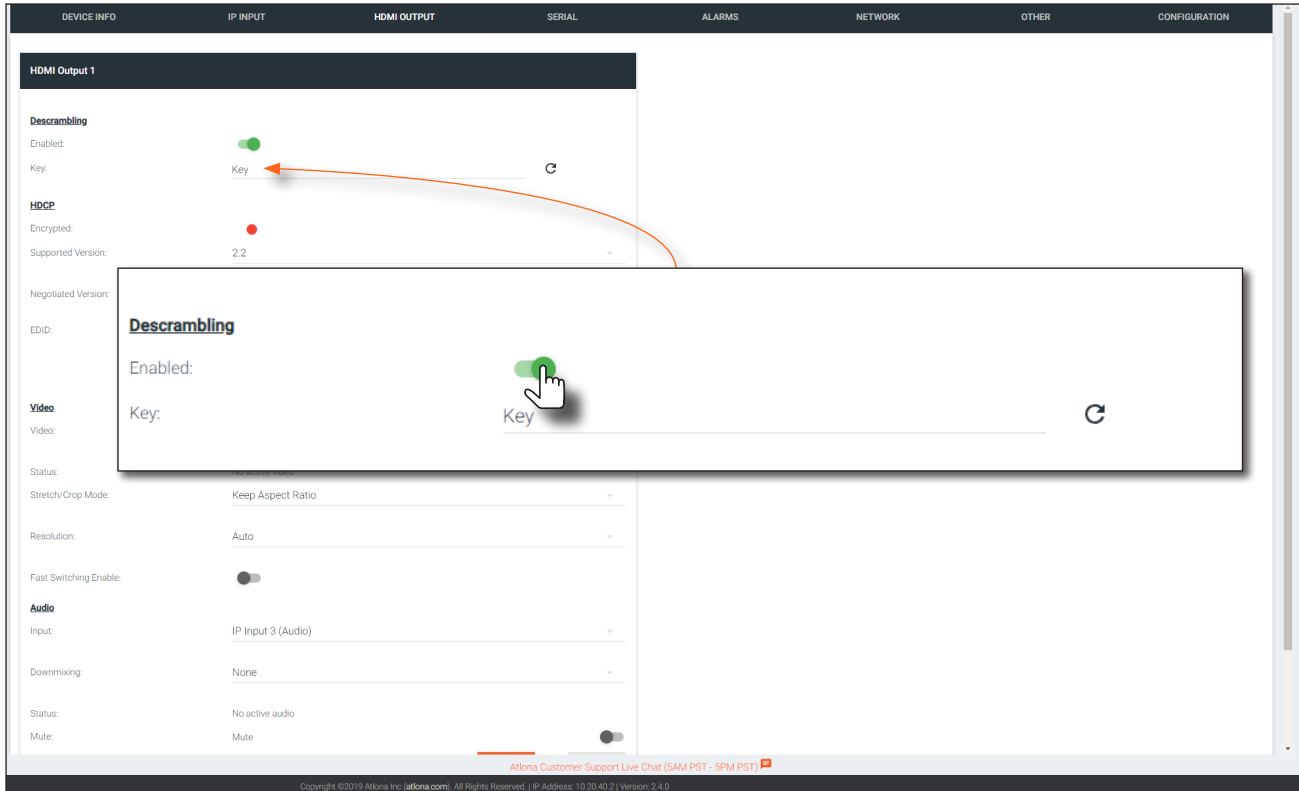

6. Click the **Save** button at the bottom of the page to commit the changes.

3. Enter the desired scrambling key in the **Key** field.



NOTE: If a user-defined key is specified, then it must be a minimum of eight alphanumeric characters. Special characters and spaces are not permitted.

4. Click the **Save** button at the bottom of the page to commit the changes.

Using the Virtual Matrix

1. Access the Virtual Matrix. Refer to [The Virtual Matrix \(page 92\)](#) for more information.
2. Locate the desired encoder or decoder. Scrambling is handled on the encoder; descrambling is handled on the decoder.
3. Click the yellow key icon. The Scrambling dialog box will be displayed. If the key icon for a decoder is clicked, then the Descrambling dialog box will be displayed.

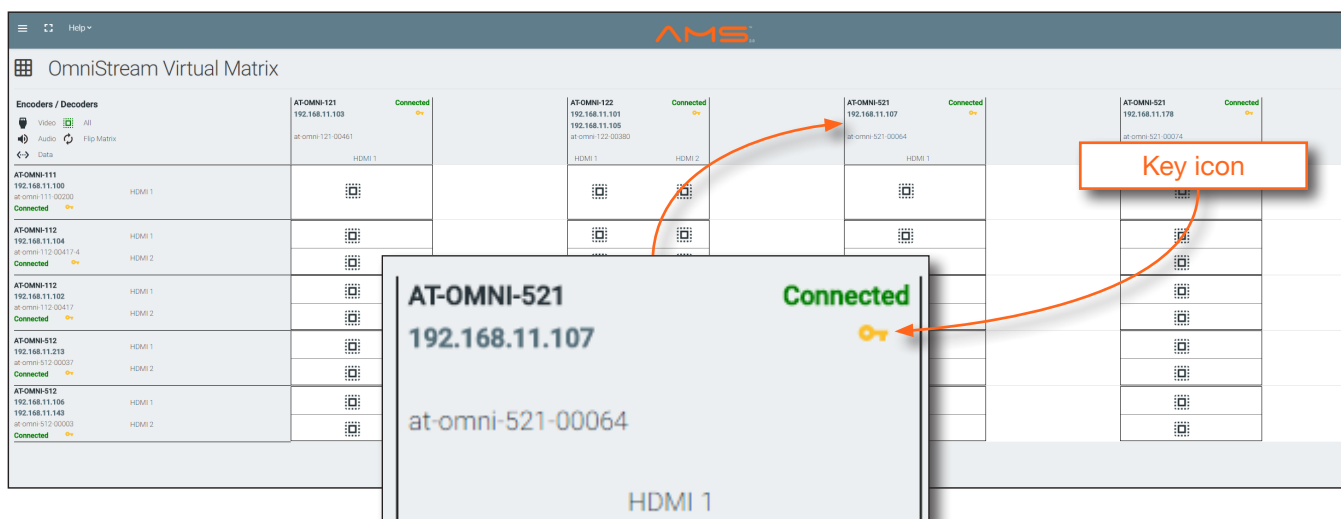

The screenshot shows the 'OmniStream Virtual Matrix' interface. It features a grid of devices, each with a 'Key icon' (a yellow key symbol). A modal window for 'AT-OMNI-521' is open, showing the following details:

- Device ID: AT-OMNI-521
- IP Address: 192.168.11.107
- Scrambling Key: at-omni-521-00064
- Status: Connected
- Output: HDMI 1

An orange callout box labeled 'Key icon' points to the yellow key icon in the modal window.

4. Click the **Enable** toggle switch to enable scrambling for the desired session.



The screenshot shows the 'Descrambling - AT-OMNI-521' dialog box. It contains the following elements:

- Title: Descrambling - AT-OMNI-521
- Section: HDMI Output
- Toggle: 'Enable' toggle switch is turned on.
- Field: 'Key' field with a refresh icon.
- Buttons: 'CLOSE' and 'SAVE' buttons at the bottom.

Creating Video Walls



NOTE: OmniStream video walls do not support 1080i sources.

The following table lists the maximum video wall size, based on the resolution of the source.

Resolution	Maximum Video Wall Size
4Kp60	2 x 2
4Kp30	16 x 16
1080p60	n x n (no limit)

Landscape Mode

The following diagram will be used to illustrate how to configure a 2 x 2 video wall. The details of this diagram are listed below:

- Four decoders are subscribed to a single encoder. Each decoder is connected to a display.
- The encoder is transmitting a 3840 x 2160 video signal.
- The top two displays have been accidentally mounted upside down.

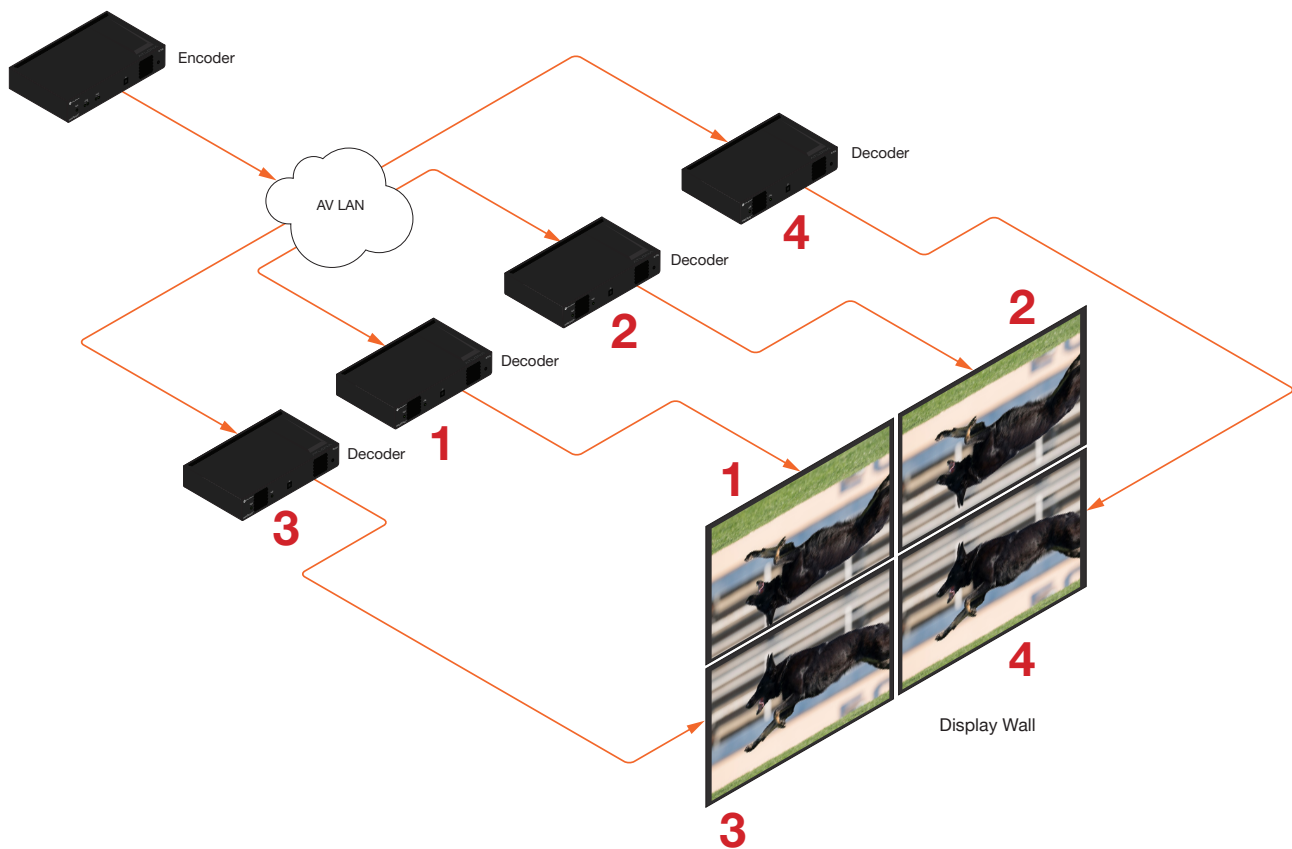

This diagram presents some challenges that need to be met:

- Since there are four displays, the image from each decoder will need to be scaled to one-fourth of the total resolution. The crop-and-scale feature will be used to provide the correct output.
- The top two displays have been mounted upside-down. To meet this challenge, the rotate feature will be applied to these two displays.

Note that the order in which each image is cropped, scaled, and/or rotated is arbitrary. In this example, the configuration process will begin with Display 1, in the top left.

1. Login to AMS. Refer to [Accessing Decoders in AMS \(page 16\)](#) if necessary.
2. Click **HDMI OUTPUT** in the menu bar.
3. Click the **SHOW ADVANCED** button.
4. Locate the **Resolution** option, in the **Video** section, and select 1920x1080. This will scale the output resolution from each decoder to 1920x1080.

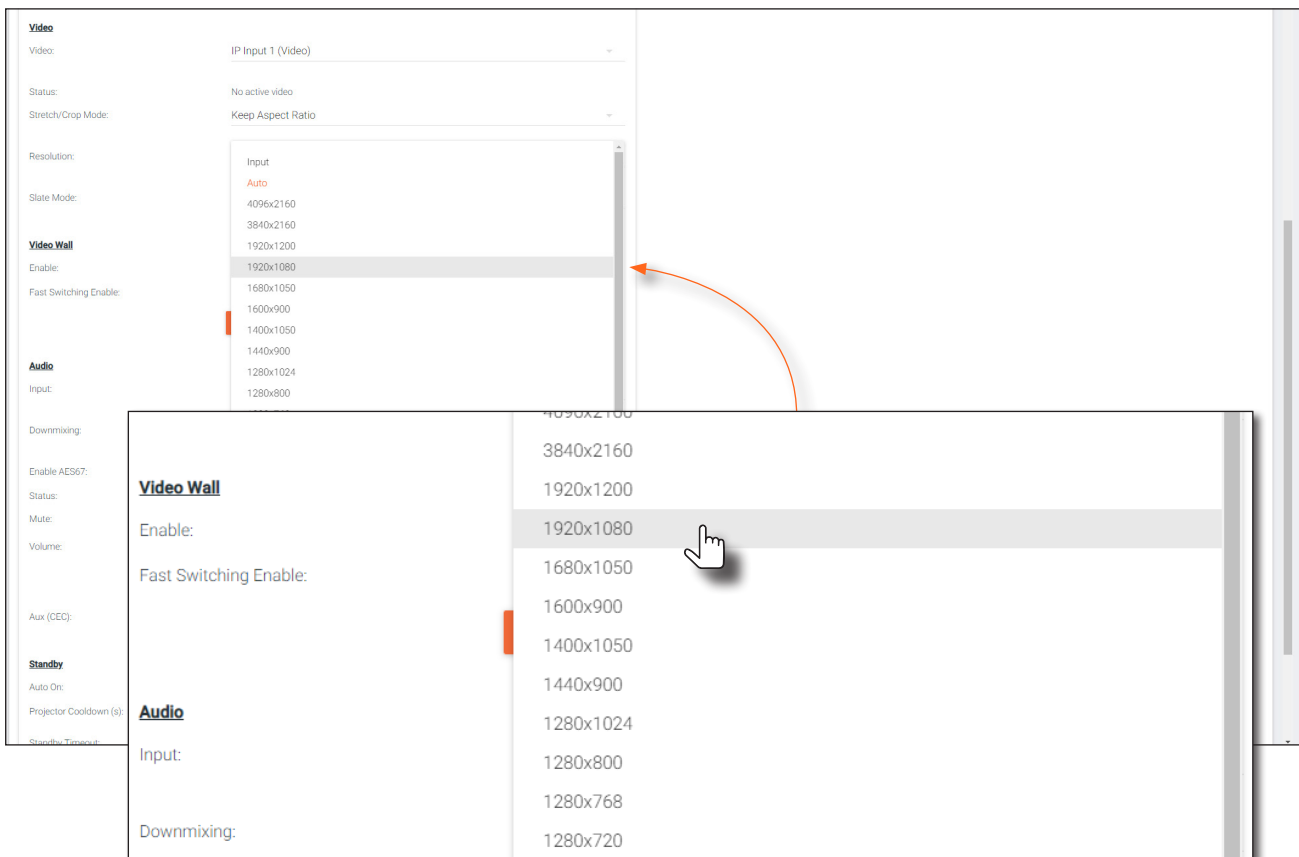

5. Click the **Stretch/Crop Mode** drop-down list and select Full Screen. This guarantees that the image will fill the screen.

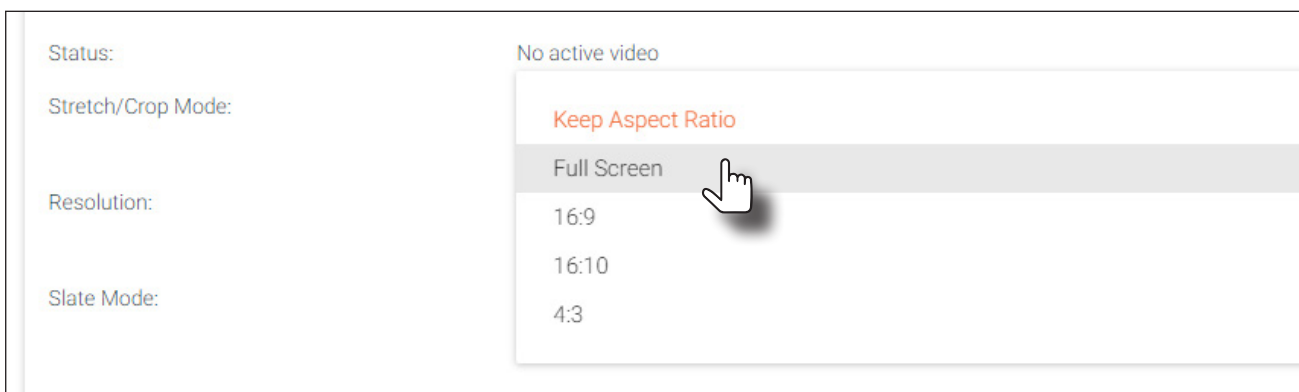

- Click the **Enable** toggle to activate the **Video wall** option. Once enabled, the **Video wall** section will be expanded and display all available options.

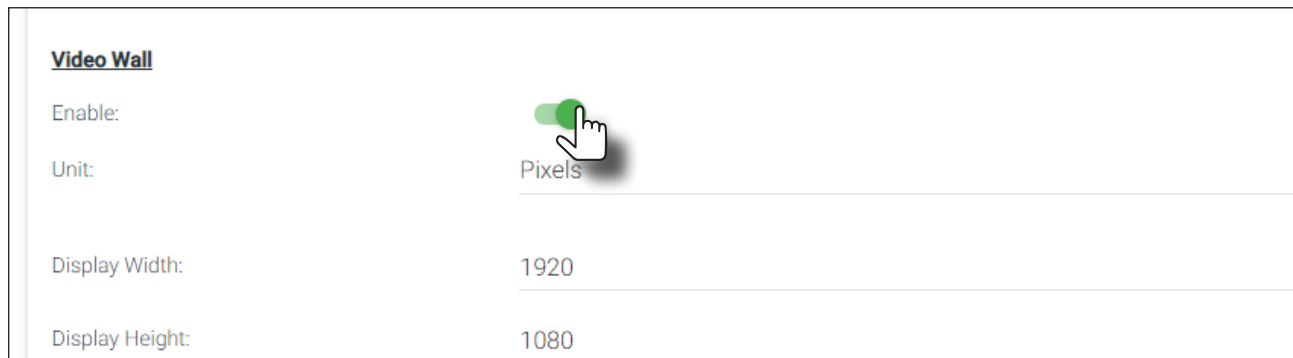

Video Wall

Enable:

Unit: Pixels

Display Width: 1920

Display Height: 1080

- Click the **Unit** drop-down list to select the unit of measure. In this example, **Pixels** (the default value) will be used.

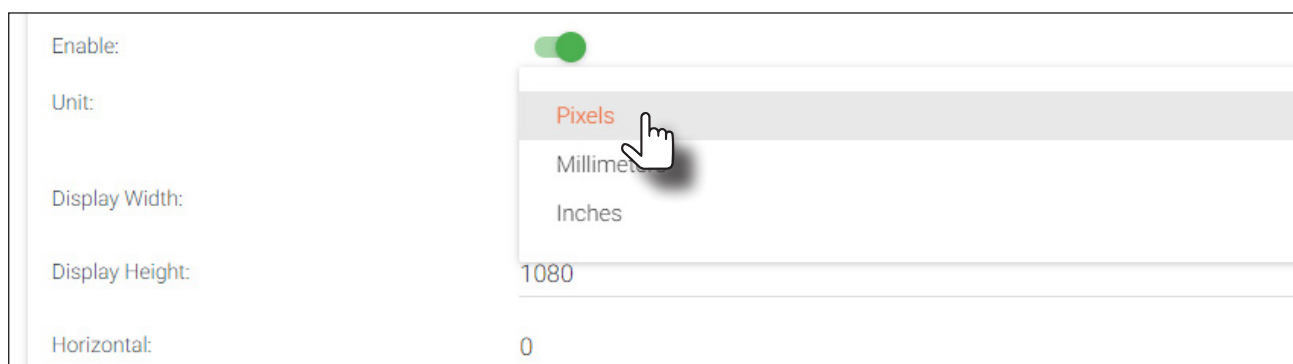

Enable:

Unit: Pixels
Millimeter
Inches

Display Width:

Display Height: 1080

Horizontal: 0

IMPORTANT: When using Millimeters or Inches, two additional fields will be available: **Video Wall Width** and **Video Wall Height**. When entering these values, the following requirement must be observed: **Video Wall Width** must be greater than or equal to the display width. **Video Wall Height** must be greater than or equal to the display height.

- Enter the horizontal and vertical resolution of the display in the **Width** and **Height** fields. This is the size of the source to be used for this window of the video wall. The table below, lists width and height examples for a 2x2 video wall, with the specified source resolution.

Source resolution	Width (pixels)	Height (pixels)
3840 x 2160 (UHD)	1920	1080
1920 x 1080 (1080p)	960	540

- Enter the number of video wall rows in the **Horizontal** field and the number of columns in the **Vertical** field. These values are the pixel start position (upper left most pixel). The table below, lists left and right coordinates for a 2x2 video wall, with the specified source resolution.

Source resolution	Upper Left	Upper Right	Lower Left	Lower Right
3840 x 2160 (UHD)	0, 0	1920, 0	0, 1080	1920, 1080
1920 x 1080 (1080p)	0, 0	960, 0	0, 540	960, 540

- Click the **Rotation** drop-down list to select the rotation angle of the image. In this example, select **180** from the drop-down list. The image will be flipped, vertically. This step is only applied when configuring the two top displays.

Horizontal:	0
Vertical:	0
Rotation (°):	<div style="border: 1px solid #ccc; padding: 2px;"> 0 180 </div>
Edge Compensation:	

The image on Display 1, as illustrated below, has been cropped and rotated and is now displayed correctly. One-fourth of the video wall has been configured.

- Click the **SAVE** button at the bottom of the screen to commit changes.
- Repeat steps 4 through 10 for decoders 2, 3, and 4. Note that in the example below, decoders 3 and 4 will not require any rotation. Therefore, make sure the **Rotation** option is set to 0 for decoders 3 and 4.

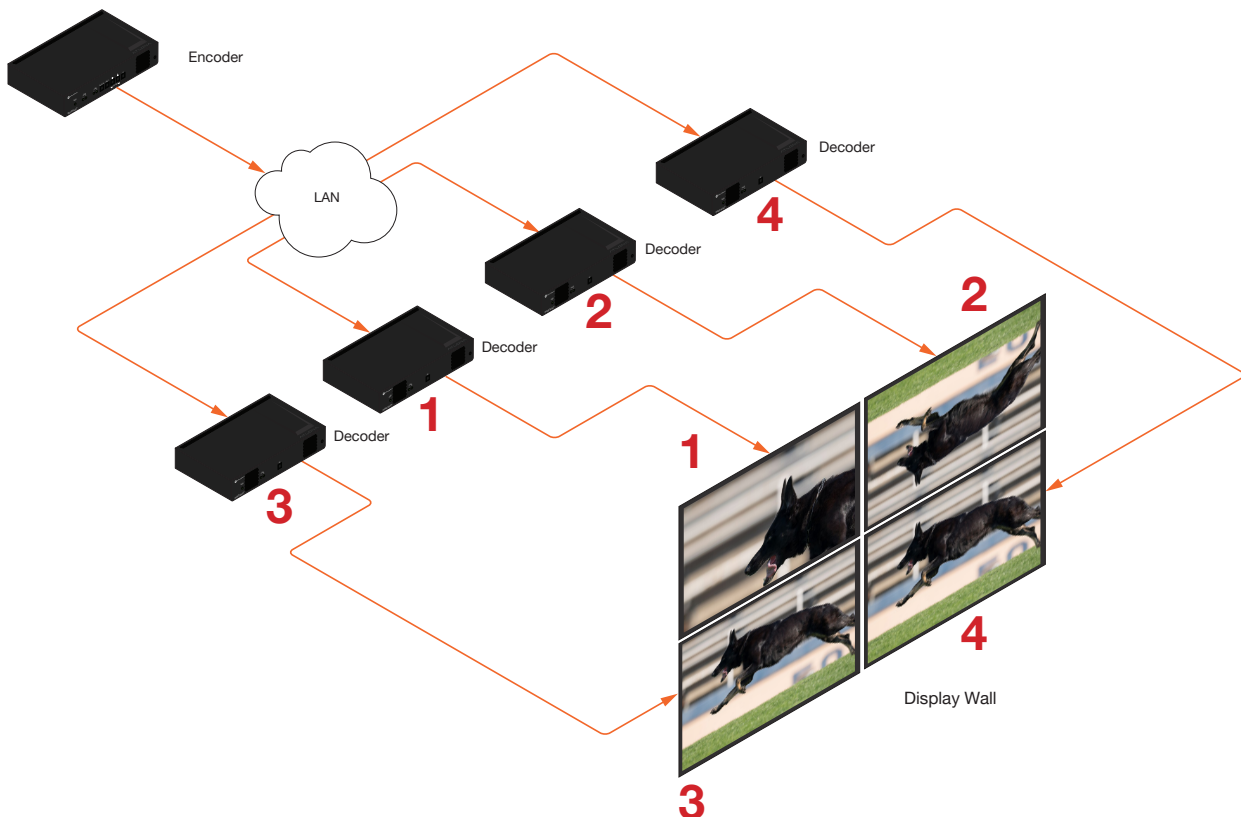

Once all four decoders have been properly configured, the video wall should appear similar to the following:

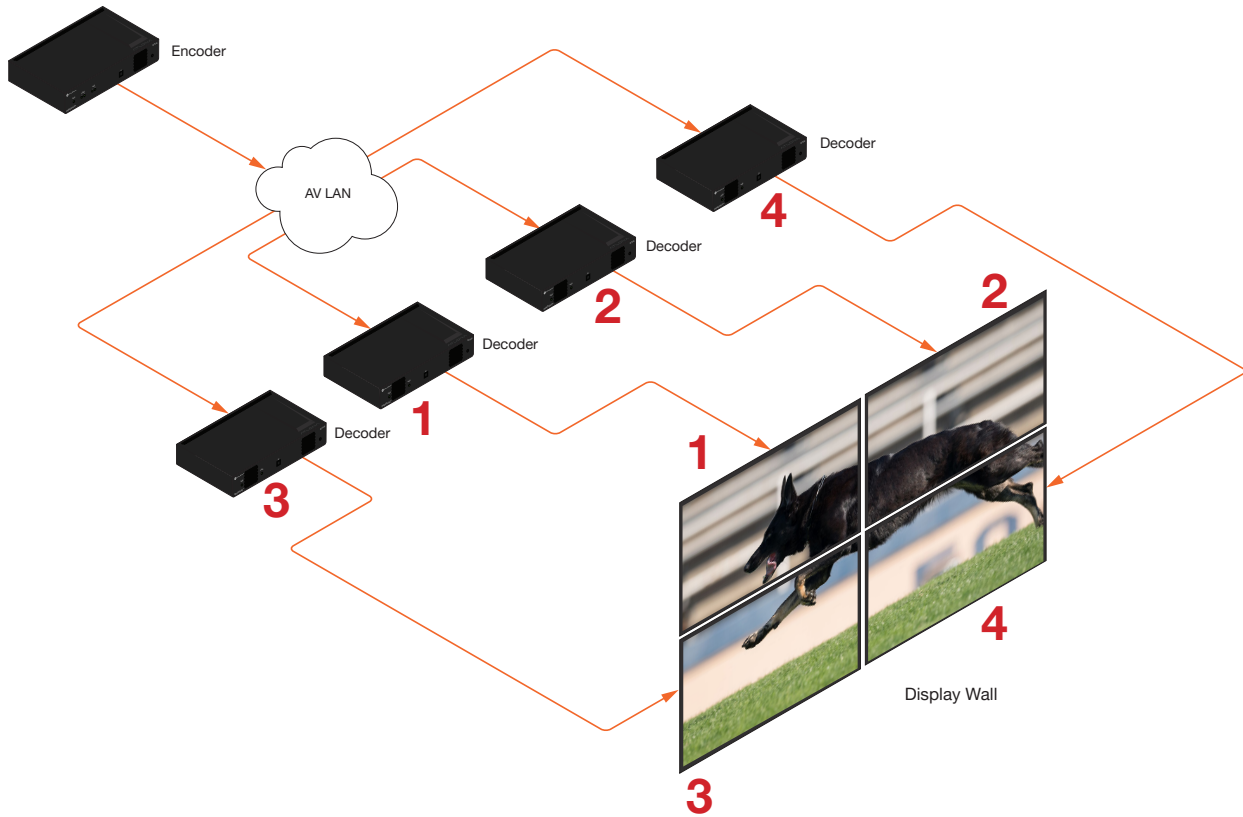

13. Check the image, on each display, and make sure they are aligned correctly with the other images on the video wall. Use the **Edge Compensation** drop-down list to select the desired bevel compensation. See the next page for more information.

Portrait Mode

Images can be rotated 90° or 270° to create portrait-oriented video walls. The steps to configure portrait-oriented video walls is very similar to creating landscape video walls.

A similar scenario to the landscape video wall challenge will be used to illustrate how to configure a 1 x 4 portrait-oriented video wall. The details of this diagram are listed below:

- Four decoders are subscribed to a single encoder. Each decoder is connected to a display.
- The encoder is transmitting a 3840 x 2160 video signal.
- Display 2 and 3 have been mounted upside-down.

Figure 2.1: Portrait-mode video wall requiring adjustment.

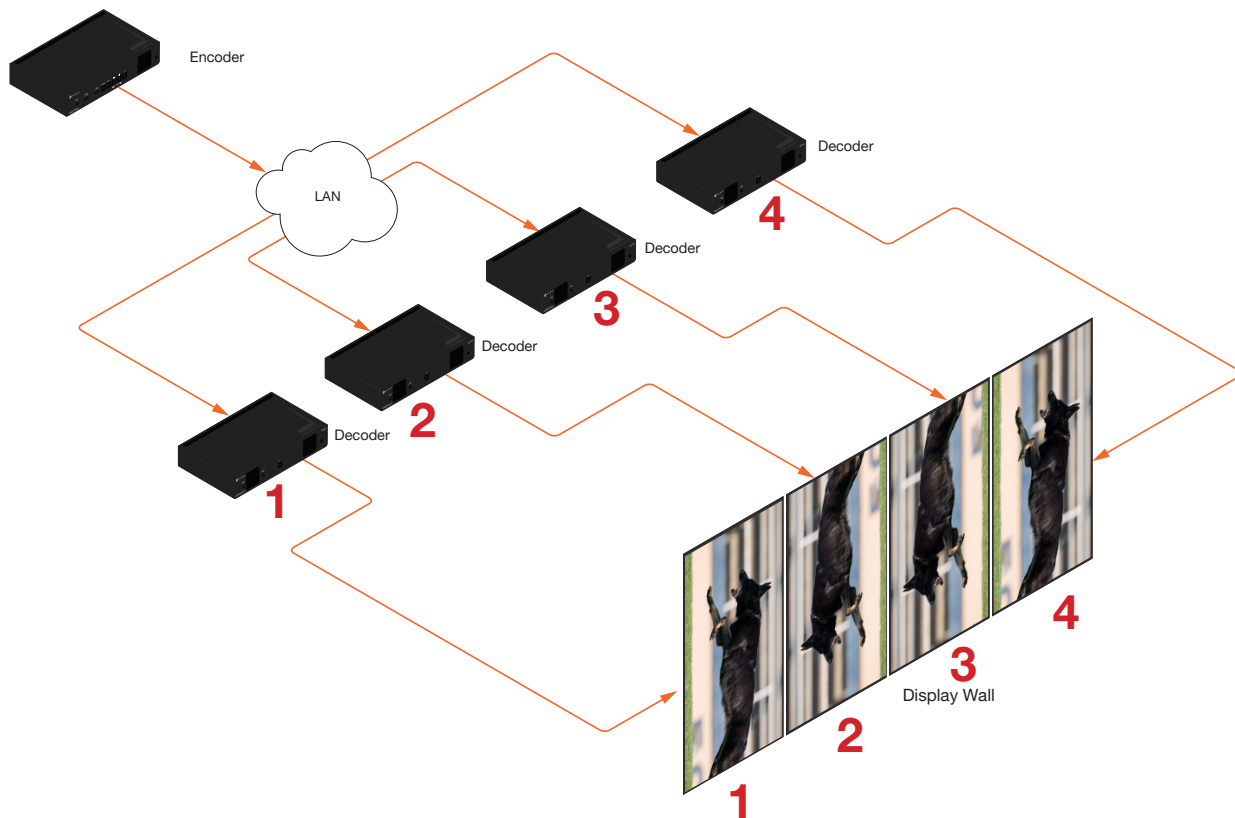

As with the landscape video wall, this diagram presents some challenges that need to be met:

- Since there are four displays, the image from each decoder will need to be scaled to one-fourth of the total resolution. The crop-and-scale feature will be used to provide the correct output.
- Display 2 and 3 have been mounted upside-down. To meet this challenge, the images must be flipped horizontally and rotated 90°, which gives a total rotation angle of 270°. Display 1 and 4 only need to be rotated 90°.

Note that the order in which each image is cropped, scaled, and/or rotated is arbitrary. In this example, the configuration process will begin with Display 1.

1. Access the built-in web server for the OmniStream decoder and login using the required username and password. The default credentials are listed below:

Username: admin
 Password: Atlona

2. Click **HDMI OUTPUT** in the menu bar.

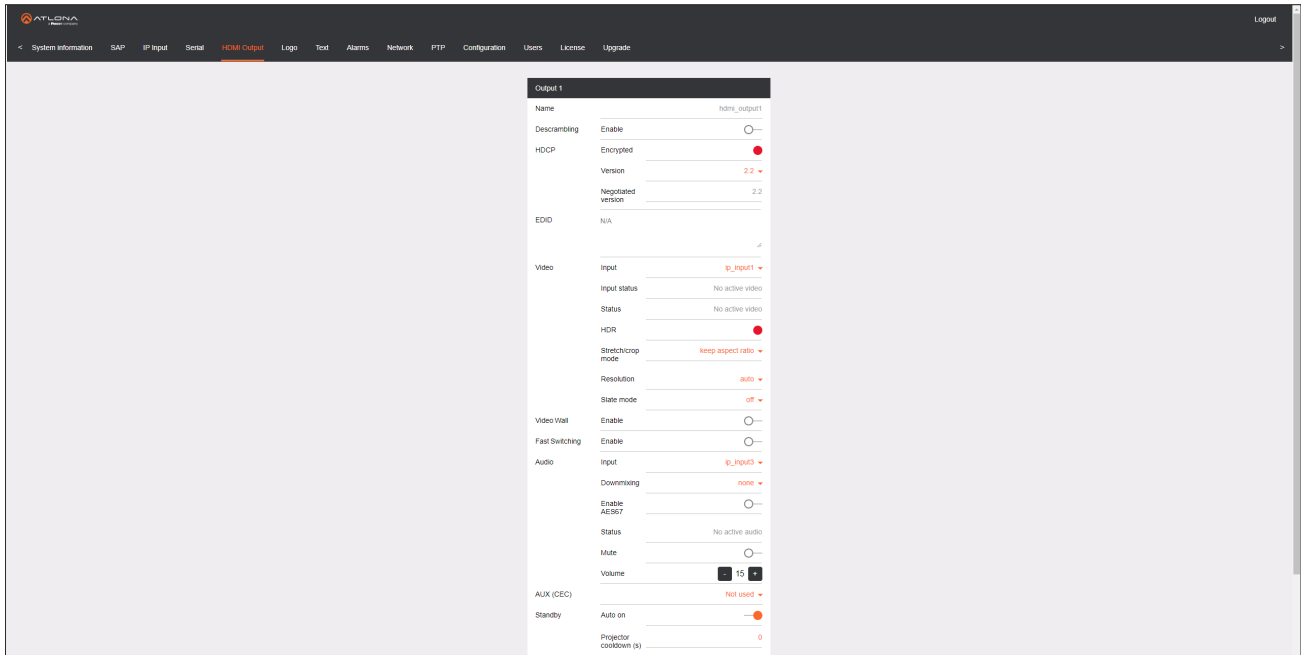

3. Locate the **Resolution** option, in the **Video** section and select 1920x1080. This will scale the output resolution to 1920x1080.

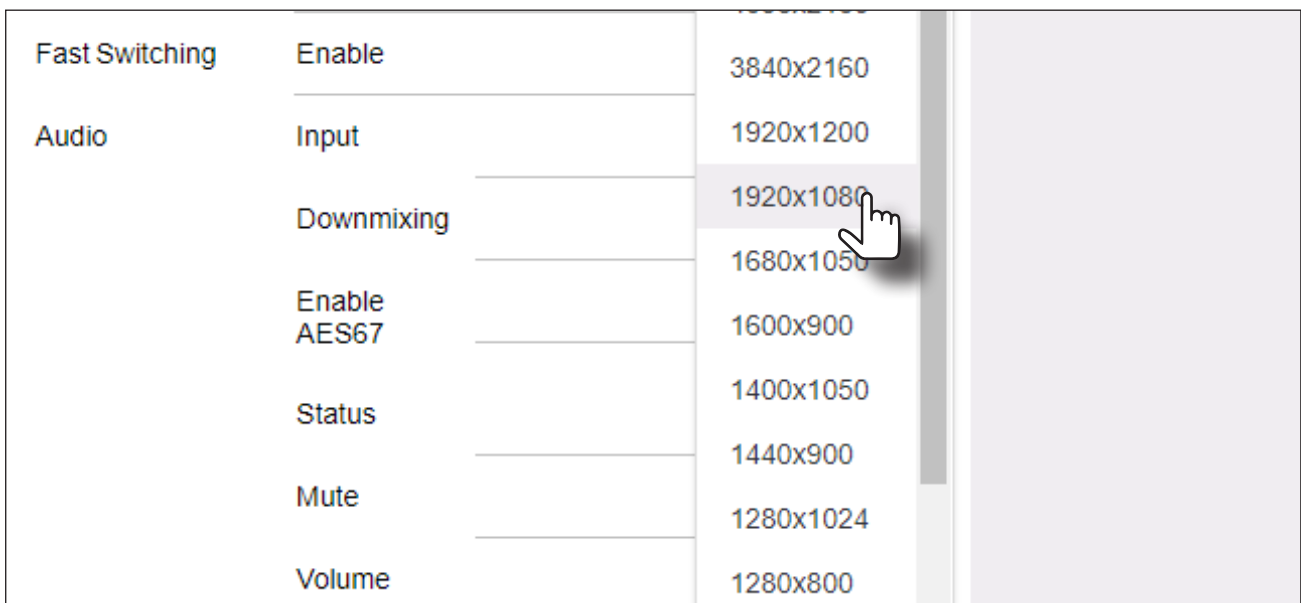

- Click the **Stretch/Crop Mode** drop-down list and select Full Screen. This guarantees that the image will fill the screen.

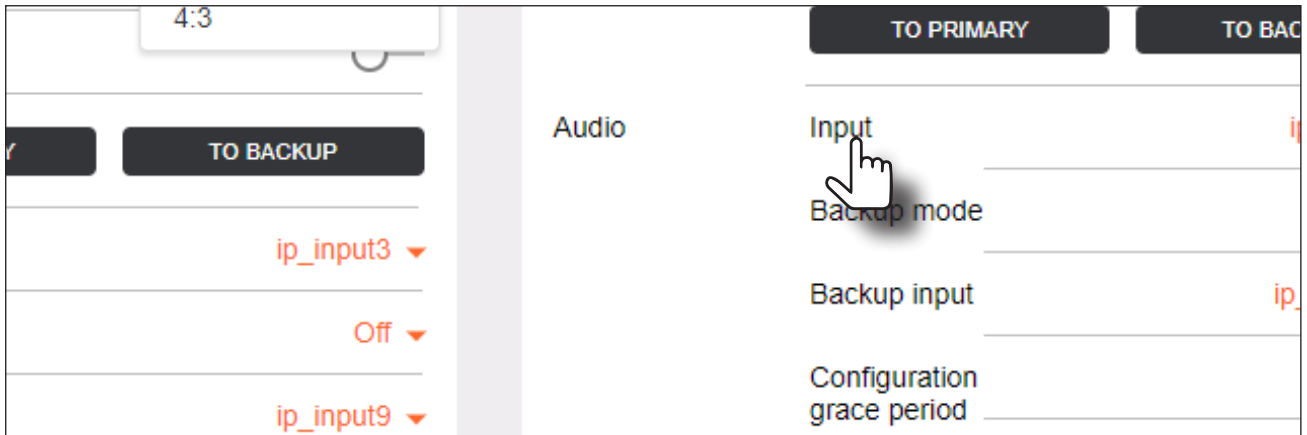

- Under the **Video Wall** section, click the **Enable** toggle to activate the **Video wall** option. Once enabled, the **Video wall** section will be expanded and display all available options.

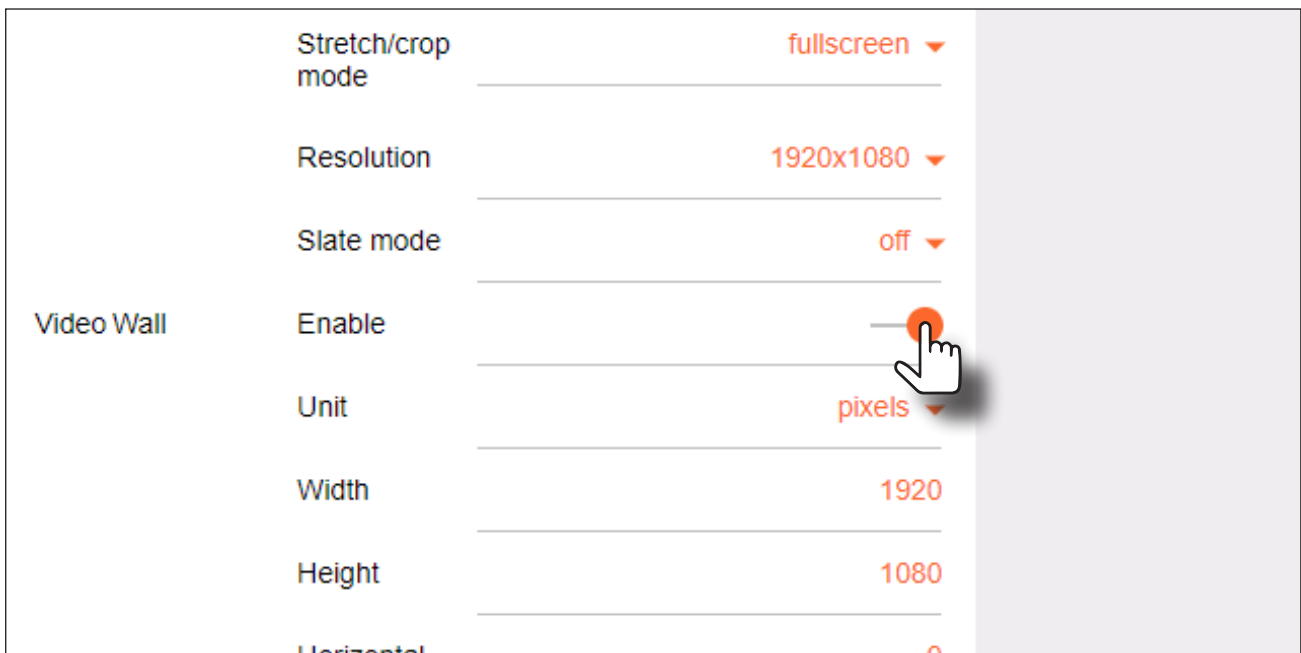

- Click the **Unit** drop-down list to select the unit of measure. In this example, **Pixels** (the default value) will be used.



IMPORTANT: When using Millimeters or Inches, two additional fields will be available: **Video Wall Width** and **Video Wall Height**. When entering these values, the following requirement must be observed: **Video Wall Width** must be greater than or equal to the display width. **Video Wall Height** must be greater than or equal to the display height.

- Enter the horizontal and vertical resolution of the display in the **Width** and **Height** fields. This is the size of the source to be used for this window of the video wall. The table on the next page, lists width and height examples for a 2x2 video wall, with the specified source resolution.

Source resolution	Width (pixels)	Height (pixels)
3840 x 2160 (UHD)	1920	1080
1920 x 1080 (1080p)	960	540

8. Enter the number of video wall rows in the **Horizontal** field and the number of columns in the **Vertical** field. These values are the pixel start position (upper left most pixel). The table below, lists left and right coordinates for a 1x4 video wall, with the specified source resolution.

Source resolution	Upper Left	Upper Right	Lower Left	Lower Right
3840 x 2160 (UHD)	0, 0	1920, 0	0, 1080	1920, 1080
1920 x 1080 (1080p)	0, 0	960, 0	0, 540	960, 540

9. Click the **Rotation** drop-down list to select the rotation angle of the image. In this example, select **90** from the drop-down list to rotate the image as portrait.

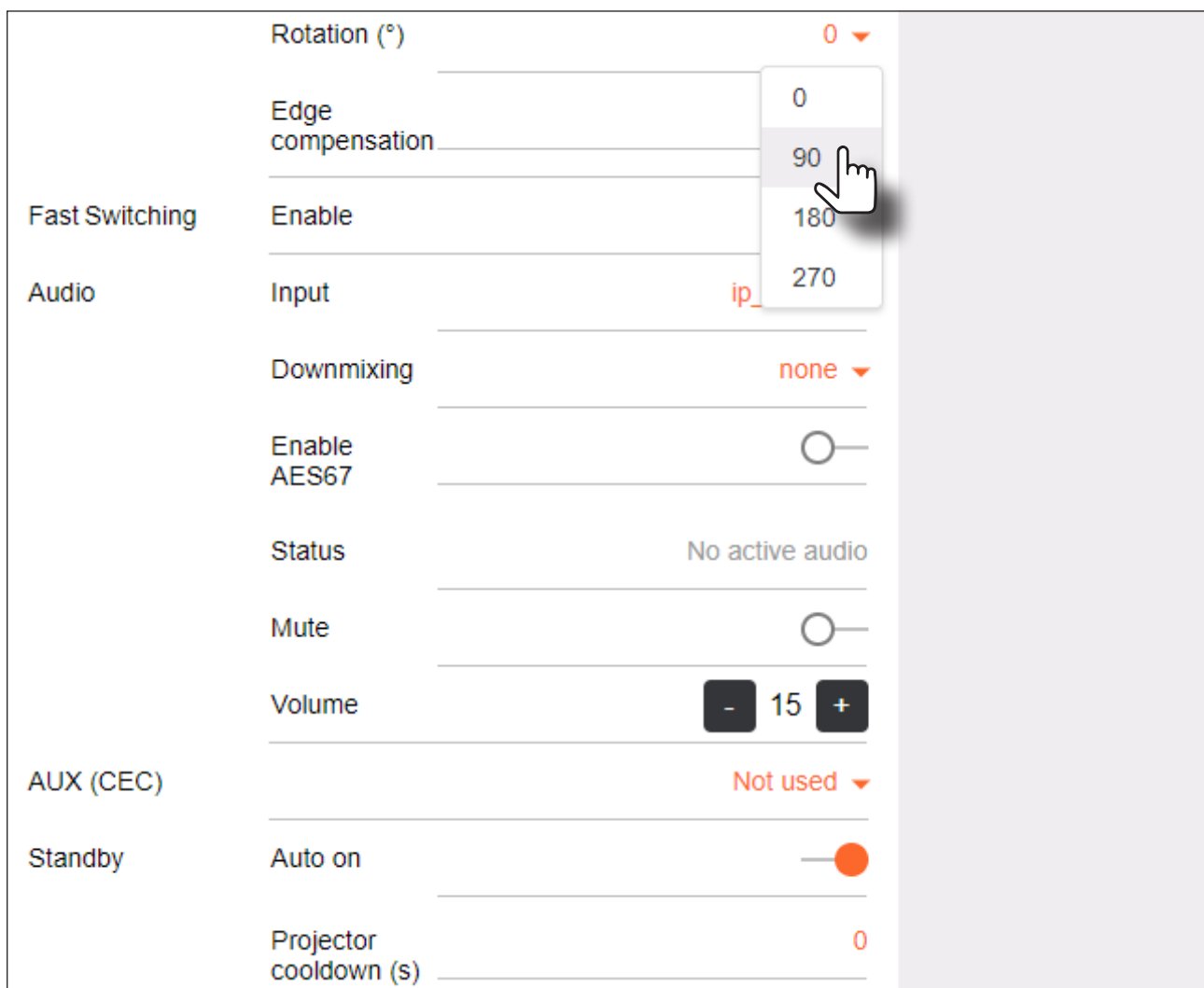

The screenshot shows the control interface for the AT-OMNI-521. The 'Rotation (°)' dropdown menu is open, showing options: 0, 90, 180, and 270. A mouse cursor is pointing at the '90' option. Other settings visible include 'Edge compensation', 'Fast Switching' (Enable), 'Audio Input' (ip_), 'Downmixing' (none), 'Enable AES67' (toggle off), 'Status' (No active audio), 'Mute' (toggle off), 'Volume' (15), 'AUX (CEC)' (Not used), 'Standby Auto on' (toggle on), and 'Projector cooldown (s)' (0).

The image on Display 1 is cropped and rotated and is now displayed correctly. At this point, one-fourth of the video wall has been configured.

Figure 2.2: Portrait-mode 1 x 4 video wall with Display 1 properly oriented.

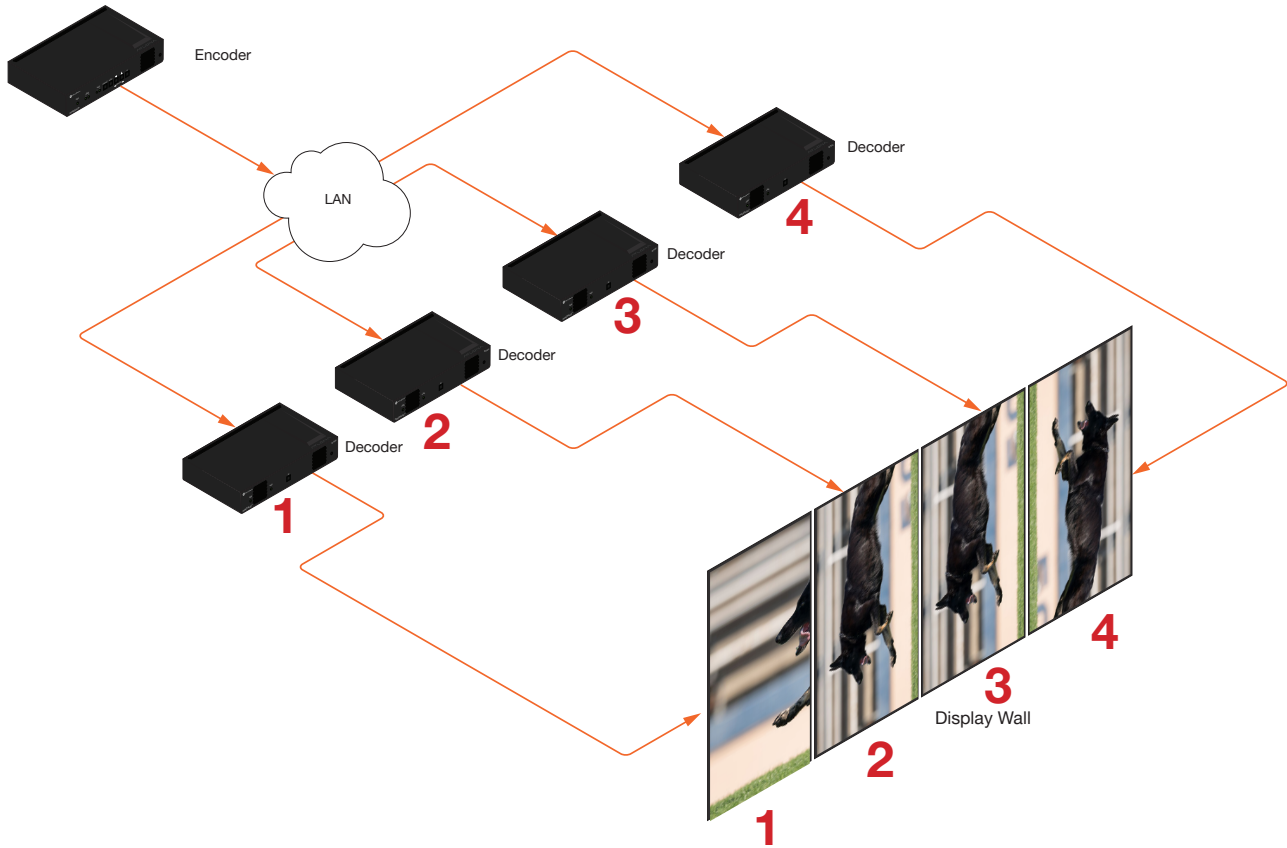

10. Click the **SAVE** button at the bottom of the screen to commit changes.
11. Repeat steps 3 through 9 for decoders 2, 3, and 4. Since display 2 and 3 were mounted upside-down, they will require a rotation of 180° (to flip horizontally) + 90° (to align them as portrait), giving a total rotation of 270°.

! IMPORTANT: When using dual-channel decoders, the **Rotation** feature can only be used when a single HDMI channel is active. Image rotation is not supported on dual-channel decoders when both HDMI channels are active. Single-channel decoders do not have this restriction.

Once all four decoders have been properly configured, the image will be correctly displayed across all four displays. Refer to the illustration on the next page.

12. Check the image, on each display, and make sure they are aligned correctly with the other images on the video wall. Use the **Edge Compensation** drop-down list to adjust bevel compensation, if necessary. Refer to [Bezel Compensation \(page 50\)](#) for more information.

Figure 2.3: Portrait-mode 1 x 4 video wall displayed correctly.

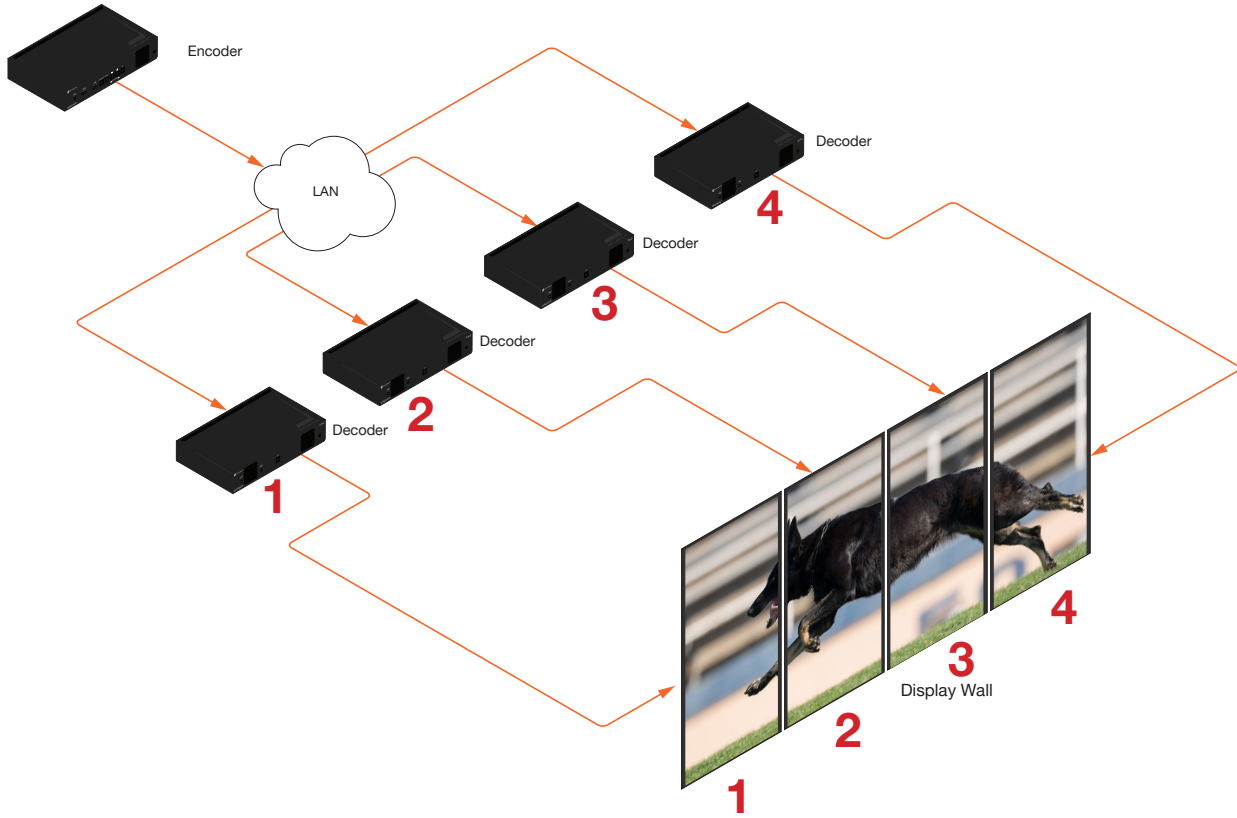

Bezel Compensation

Displays have a region where video is not displayed, called the bezel. This can cause display issues when creating video walls. Bezel compensation takes this area into account when a single video source is mapped across multiple displays. Bezel compensation can be adjusted at any time.

The illustration on the left shows a simple 2x2 video wall without bezel compensation. Note how the Atlona logo is stretched, horizontally. On the right, bezel compensation is used to correct the “distorted” image.

Image without bezel compensation



Image with bezel compensation applied



Bezel

1. Locate the **Bezel Compensation** from the **Edge Compensation** drop-down list.

Horizontal:	0
Vertical:	0
Rotation (°):	0
Edge Compensation:	<div style="border: 1px solid #ccc; padding: 2px;"> None Bezel Compensation </div>
Fast Switching Enable:	

2. Adjust the **Top**, **Bottom**, **Left**, and **Right** values, as desired. All entered values are applied to the physical displays in 1 pixel increments. Refer to the examples, below, to properly calculate the amount of bezel compensation.

If one bezel needs compensating in each direction (e.g. on a 2x2 wall, where only bezel is in the way, in each direction), use the following formula:

$$\text{Bezel width (px)} = \left(\frac{\text{Total width (px)}}{[\text{display area width (in/mm)} + \text{bezel width (in/mm)}]} \right) \times \text{bezel width (in/mm)}$$

If two bezels need compensating (e.g. on a 3x3 wall, where the middle display has two bezels is in the way, in each direction), use the following formula:

$$\text{Bezel width (px)} = \left(\frac{\text{Total width (px)}}{[\text{display area width (in/mm)} + \text{bezel width \#1 (in/mm)} + \text{bezel width \#2 (in/mm)}]} \right) \times \text{bezel width (in/mm)}$$

3. Click the **SAVE** button at the bottom of the screen to accept changes.

Video Walls using Velocity

The following section provides instructions on creating and using video walls with the Atlona Velocity Control Software. Familiarity with the Velocity software is assumed. Refer to the *Atlona Velocity User Manual* for more information, if necessary.

NOTE: As of this writing, the Velocity™ software is limited to a maximum video wall size of 12 x 12, for resolutions of 4Kp30 and 1080p60.

1. Launch a web browser and enter the IP address of Velocity, in the address bar.
2. Enter the required login credentials.
3. Click the **Login** button.
4. The Velocity Dashboard will be displayed.
5. Click the ☰ icon, in the upper-left corner, to display the fly-out menu.

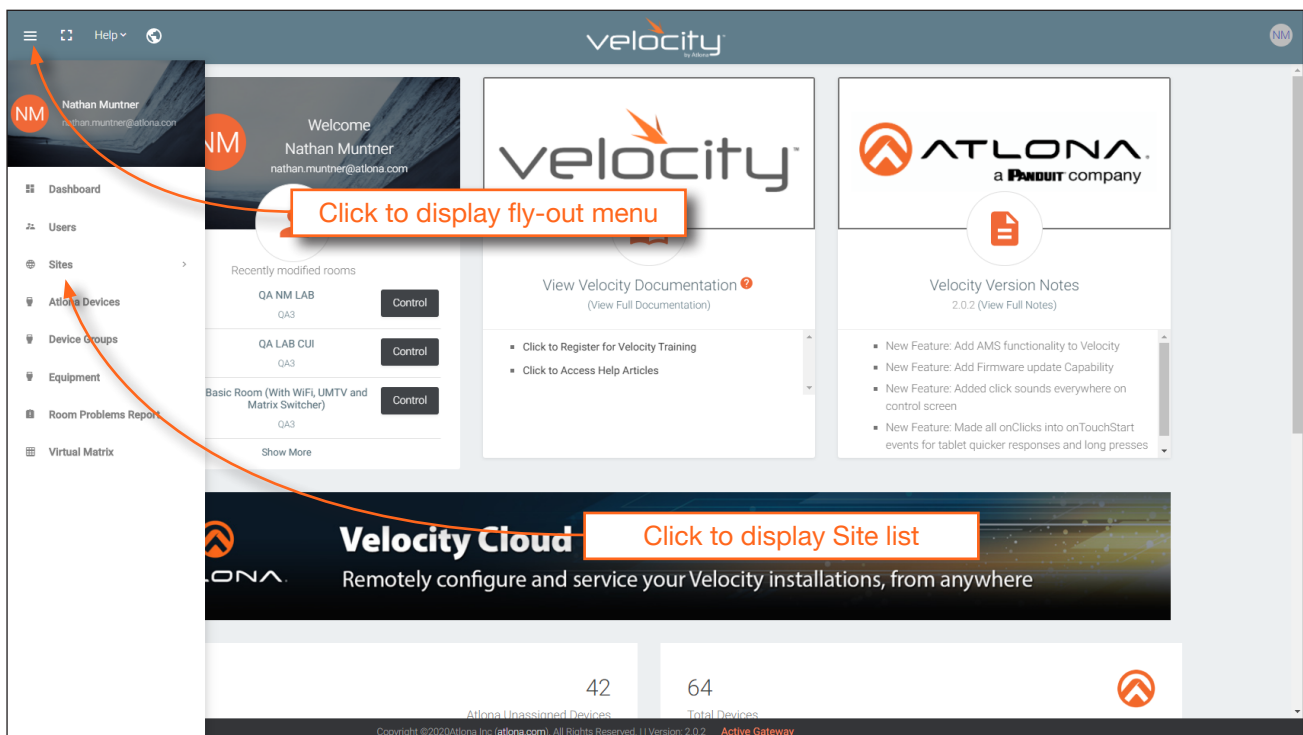

6. Click **Sites** in the menu bar to expand the list of buildings and rooms.
7. Click the desired room from the **Site** list.

NOTE: it is assumed that the selected room has already been populated with enough displays to construct a video wall, along with required number of OmniStream encoders and decoders. Refer to the Velocity User Manual for more information on adding displays and OmniStream units to a room.

- The **Modify Room** screen will be displayed. Click the **Add Technology** icon in the top far-right corner of the screen. This icon is represented by the + sign.

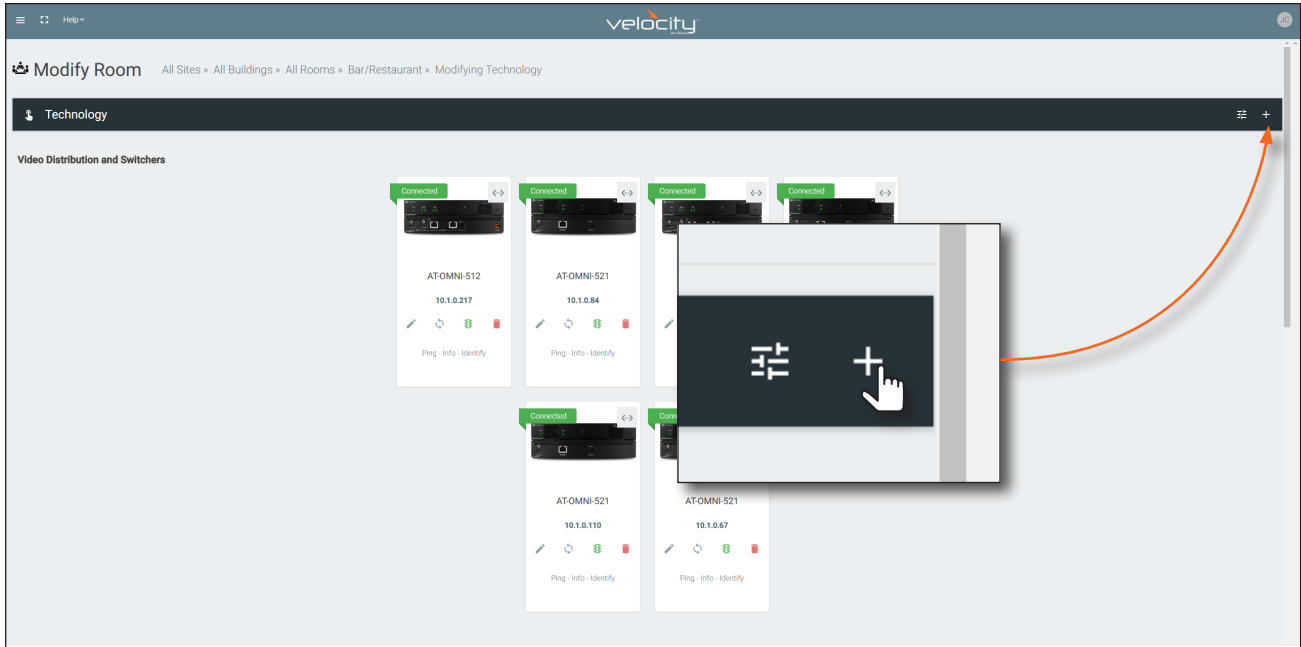

- The **Technology** fly-out menu will display.
- In the fly-out menu, click **Miscellaneous > Atлона >** to expand the Atлона technology menu.
- Click the **Quick Add** button for **Velocity Video Wall: VELOCITY-VIDEO-WALL**. The video wall technology will be added to the room.

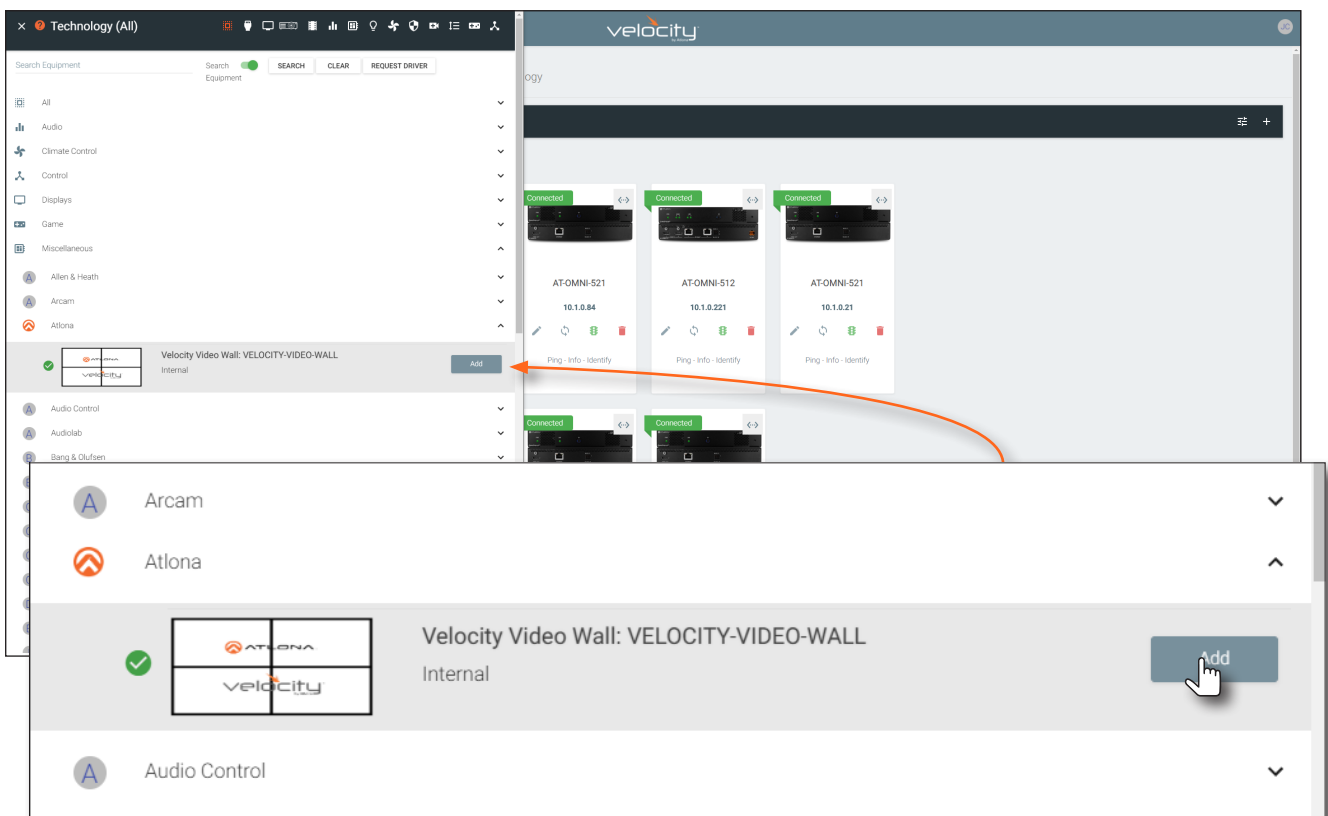

12. Scroll down to the bottom of the page and locate the **Velocity Video Wall** driver.
13. Click the **Edit** icon. This icon is represented by a pencil.

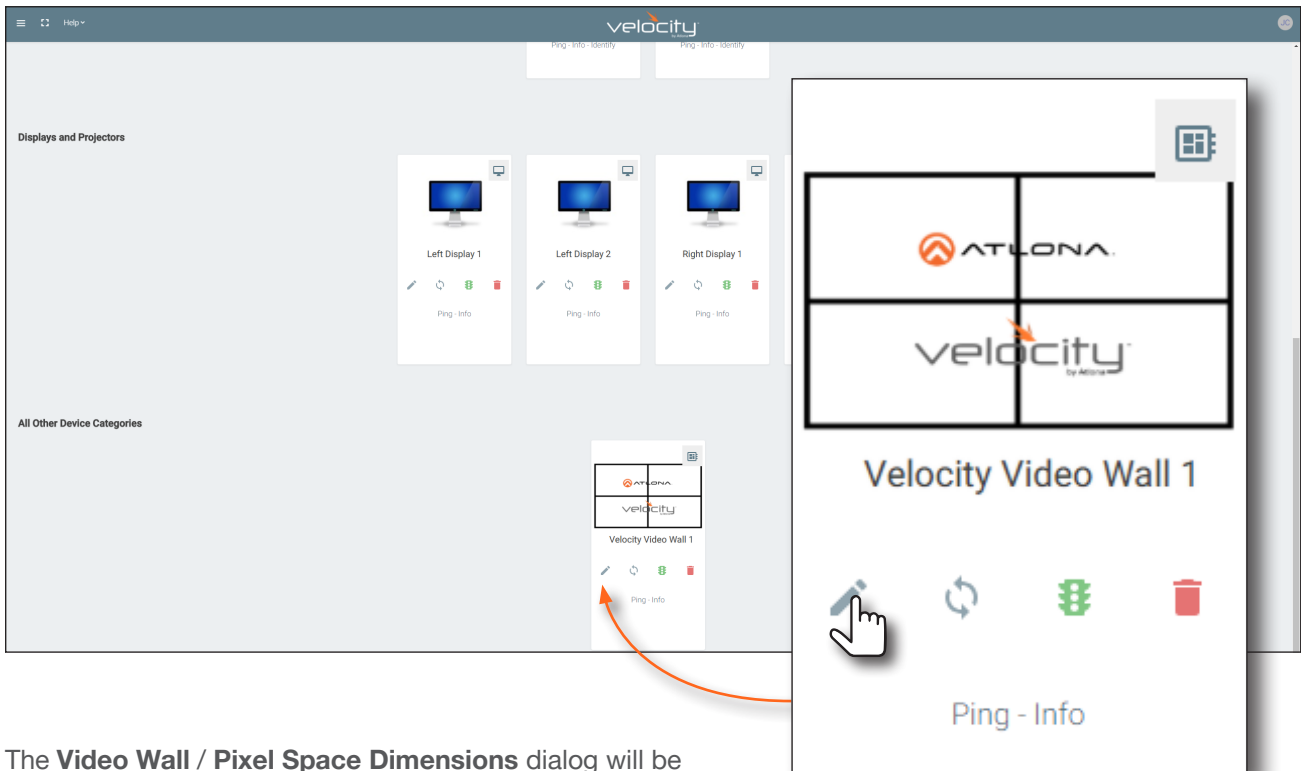

14. The **Video Wall / Pixel Space Dimensions** dialog will be displayed. This dialog will automatically be displayed when the video wall driver is edited for the first time.

The default video wall dimensions are set to 3840 x 2160. To modify the video wall size, follow steps 14a through 14e. To continue with the default video wall dimensions, click the **CLOSE** button and go to step 15.

- a. Click the **Lock Pixel Space** toggle switch to disable it. When disabled, the toggle switch will turn gray.
- b. Under **Pixel Space Dimensions**, click the drop-down list to select the desired video wall dimensions.

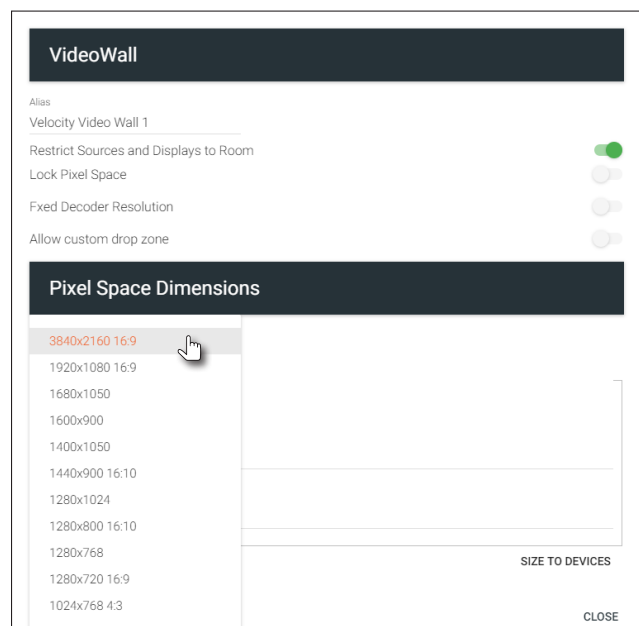
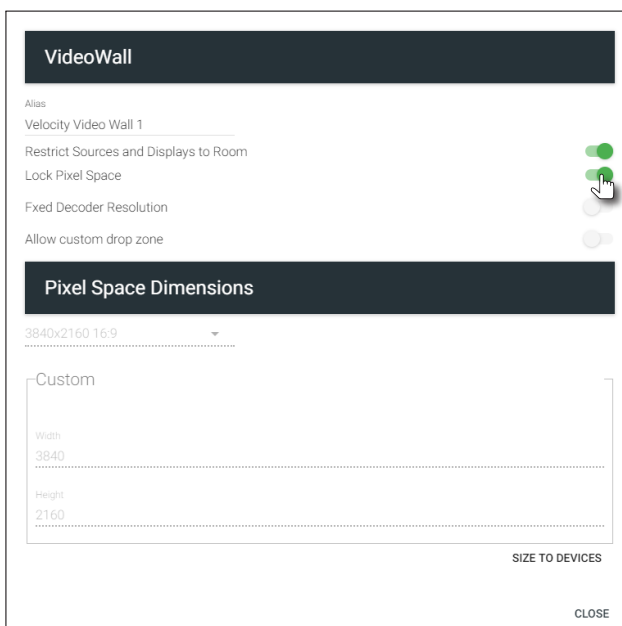

- c. To create a custom size for the video wall, enter the desired dimensions under the **Custom** section. Enter the width and height directly, or use the spinner controls at the far end of each field, to adjust the values.
 - d. Save the video wall dimensions by clicking the **Lock Pixel Space** toggle switch to enable it.
 - e. Click the **CLOSE** button to dismiss the dialog.
15. The **Video Wall Configuration** screen will be displayed and will automatically be set to edit displays mode. This mode allows displays in the **Pixel Space** window to be added, removed, and arranged. In this mode, the **Displays** icon will be green.

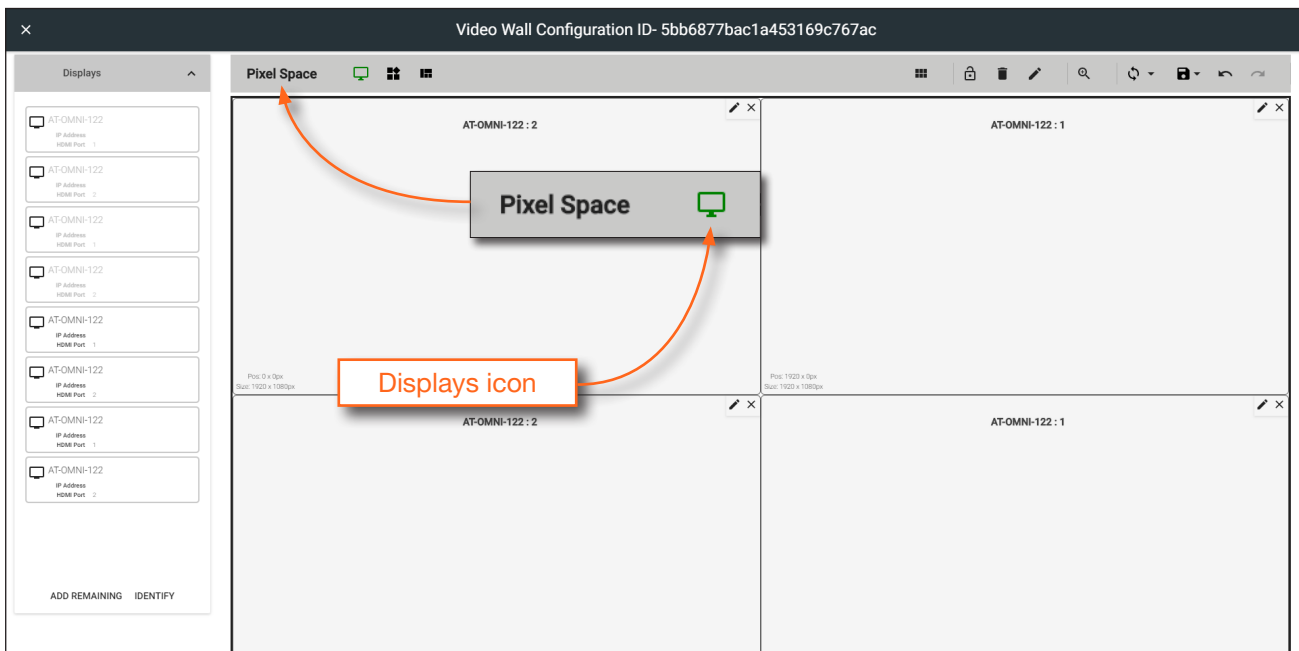

The following identifies each icon in the **Pixel Space** toolbar.

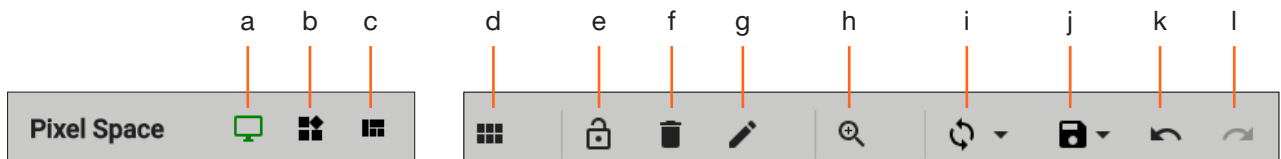

- | | |
|--|--|
| <p>a. Displays
Click to icon to show the Displays window on the left side of the screen. In this mode, displays can be edited.</p> <p>b. Presets
Click this icon to display the Presets window on the left side of the screen. In this mode, presets can be edited, added, or deleted.</p> <p>c. Drop Zones
Click this icon to display the Drop Zones window on the left side of the screen. Refer to Creating and Using Drop Zones (page 64) for more information.</p> | <p>d. Auto Arrange
Click this icon to auto-arrange the number of displays in the Pixel Space window into the selected number of rows and columns.</p> <p>e. Lock
When locked, this icon will turn red, and prevent accidental repositioning of displays or changing presets. To unlock the displays (for adjustment purposes), click this icon again.</p> <p>f. Delete All
Click this icon to delete all displays within the Pixel Space window. This icon will only be available if displays are present in the Pixel Space window.</p> |
|--|--|

a. Pixel Space

Click this icon to display the **VideoWall** dialog box, allowing modification of both the Video Wall and Pixel Space settings.

b. Zoom

Click this icon to display the zoom fly-out slider control. Click and drag the slider to adjust the zoom factor of the **Pixel Space** window.

i. Apply Preset

Click this icon to apply the current preset. Click the down arrow next to this icon to display the Apply Preset fly-out menu. This control defines when Velocity automatically applies a preset: 1) Auto apply preset on save; 2) Auto apply preset on source change.

j. Save

Click this icon to save the current layout/settings. Click the down-arrow, next to this icon, to display the Save fly-out menu option, allows enabling or disabling of auto-saving.

k. Undo

Click this icon to undo the last operation.

l. Redo

Click this icon to redo the last operation. Clicking this icon after an undo operation will restore the previous setting.

16. Under the **Displays** window, on the left side of the screen, drag and drop the desired displays to the **Pixel Space** window.

Alternatively, to add all displays to the **Pixel Space** windows without manually using drag-and-drop, click **ADD REMAINING**, at the bottom of the Displays window. This will automatically populate the **Pixel Space** window with all available displays. For this example, four displays will be added, manually.

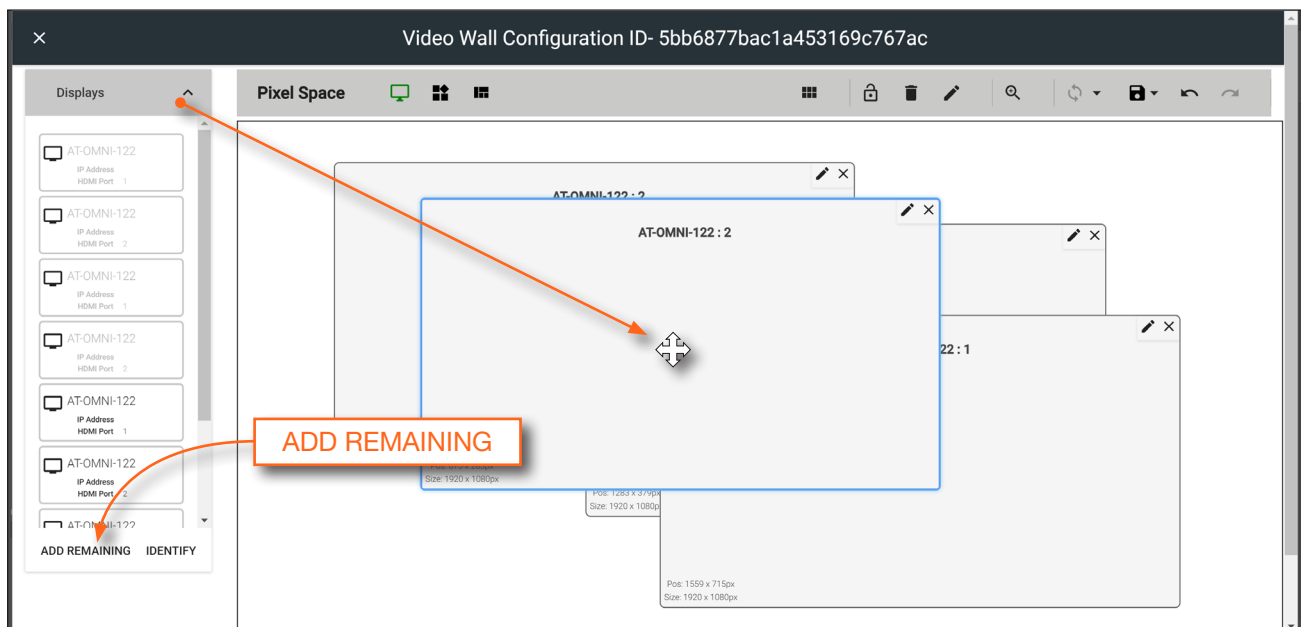

NOTE: The order in which the displays are placed in the **Pixel Space** window is not important and both the number of displays and how they are arranged can always be changed at a later time.

17. Click the **Auto Arrange** icon in menu bar at the top of the **Pixel Space** window. Move the mouse within the **Auto Arrange** pop-up dialog to adjust the size of the video wall. Click the lower right-most blue square of the video wall to commit the selection. In this example, a 2x2 video wall will be created.

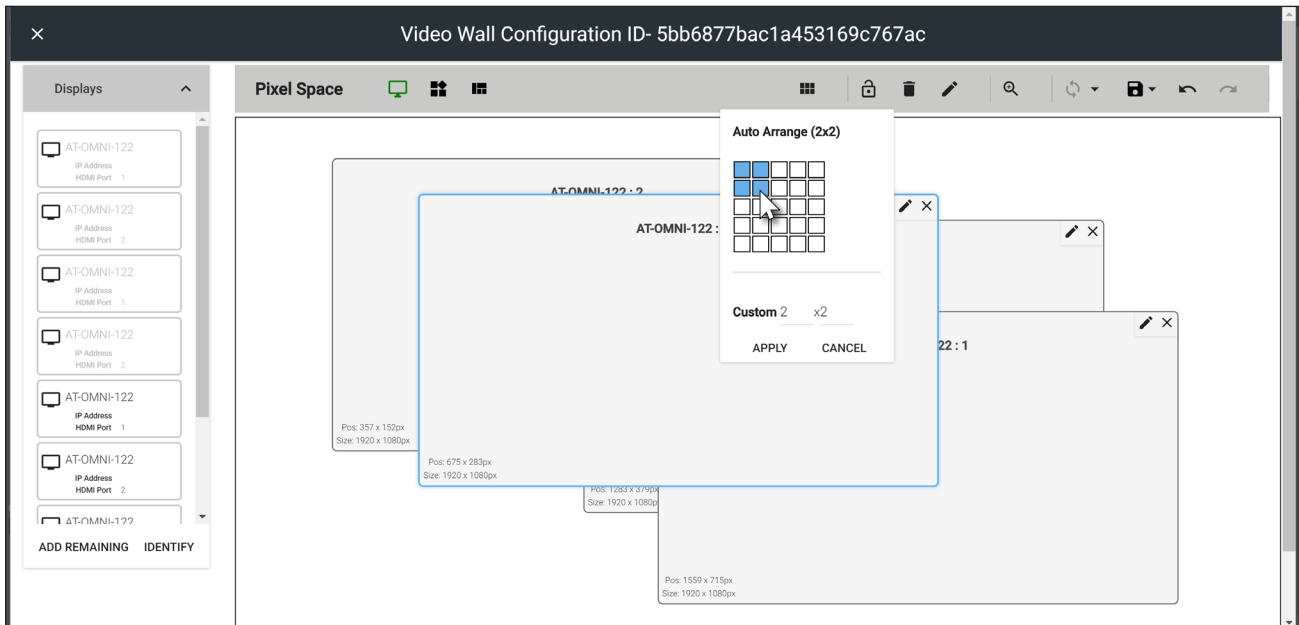

Once **Auto Arrange** has been applied, the **Pixel Space** window will appear similar to the illustration below. It should be noted that each display can be rearranged if necessary. To reposition displays, click and drag them to the appropriate places, within the **Pixel Space** window. Note that each display is identified with a name and an IP address, in the upper-left corner. Refer to the *Atlona Velocity User Manual* for more information on naming devices.

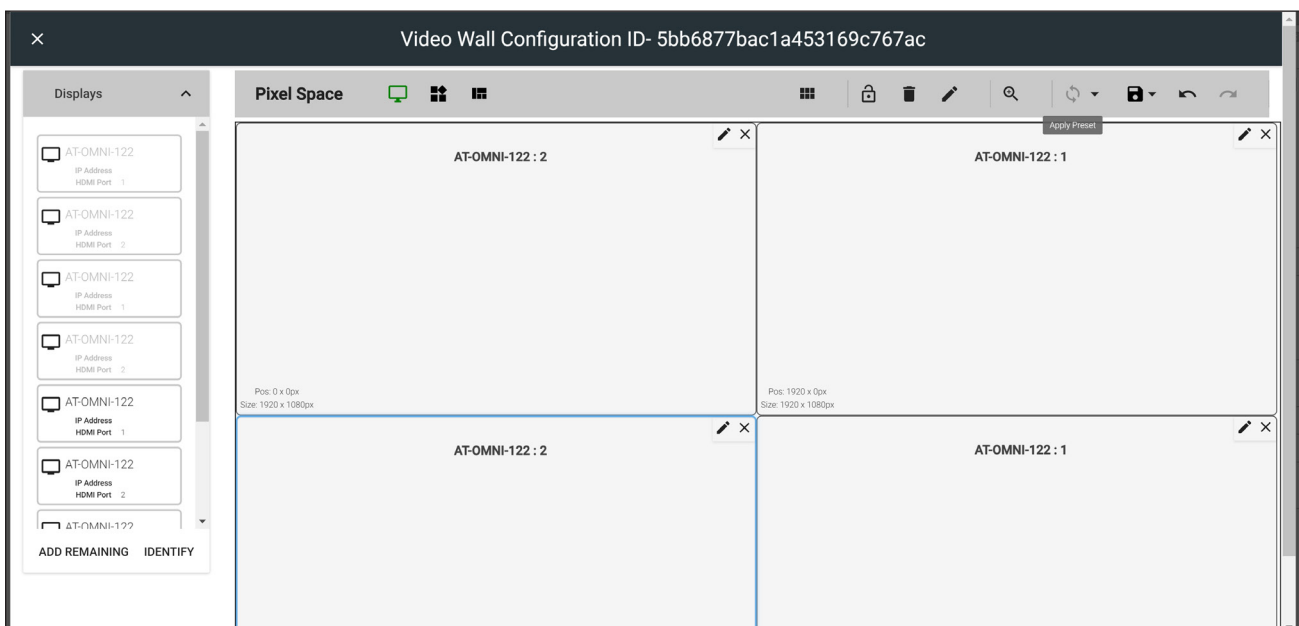

18. Click the **Lock Displays** icon in the menu bar of the **Pixel Space** window. This is optional. However, enabling this feature will prevent accidental repositioning of the displays, during the configuration procedure. When locked, this icon will turn red. Both the **Trash** and **Auto Arrange** icons will be disabled. To unlock the displays (for adjustment purposes), click the **Lock Displays** icon again.
19. Click the **Save** icon in the upper-right corner of the **Pixel Space** window. This will save the current layout.

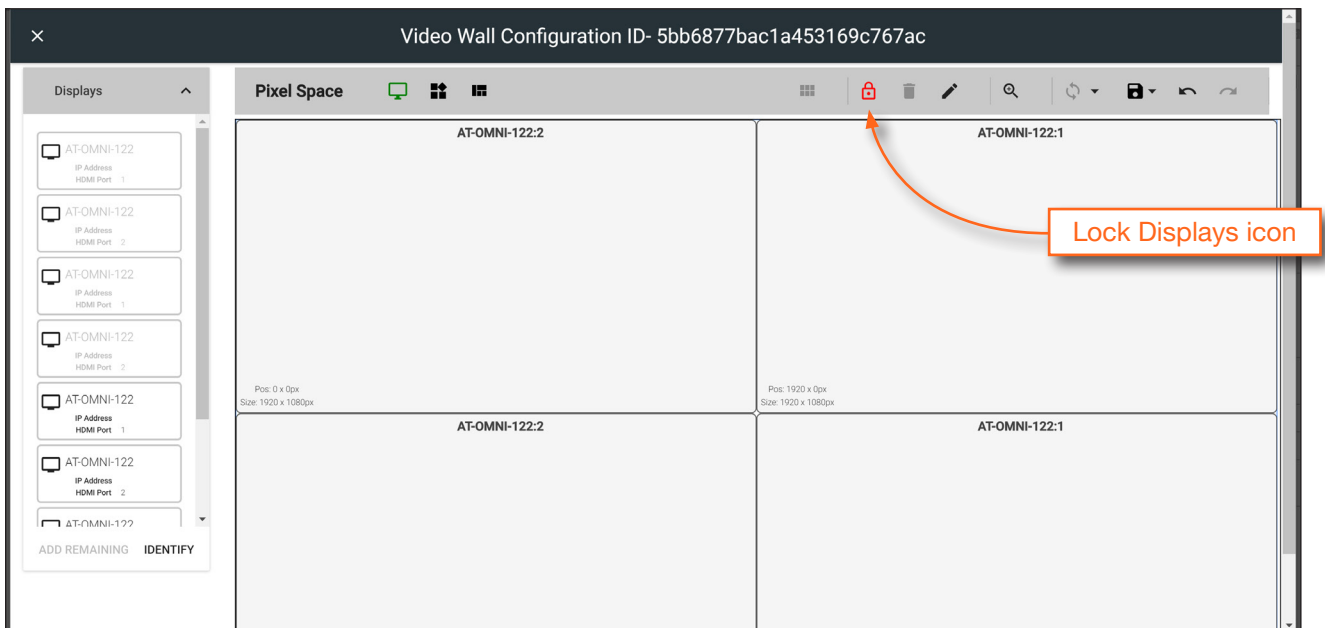

Creating Presets

Presets are used to save window layouts, within the **Pixel Space** window. Once a preset is created it can be recalled at any time.

1. Click the **Presets** icon. When clicked, this icon will turn green and the Presets window will be displayed on the left side of the screen.

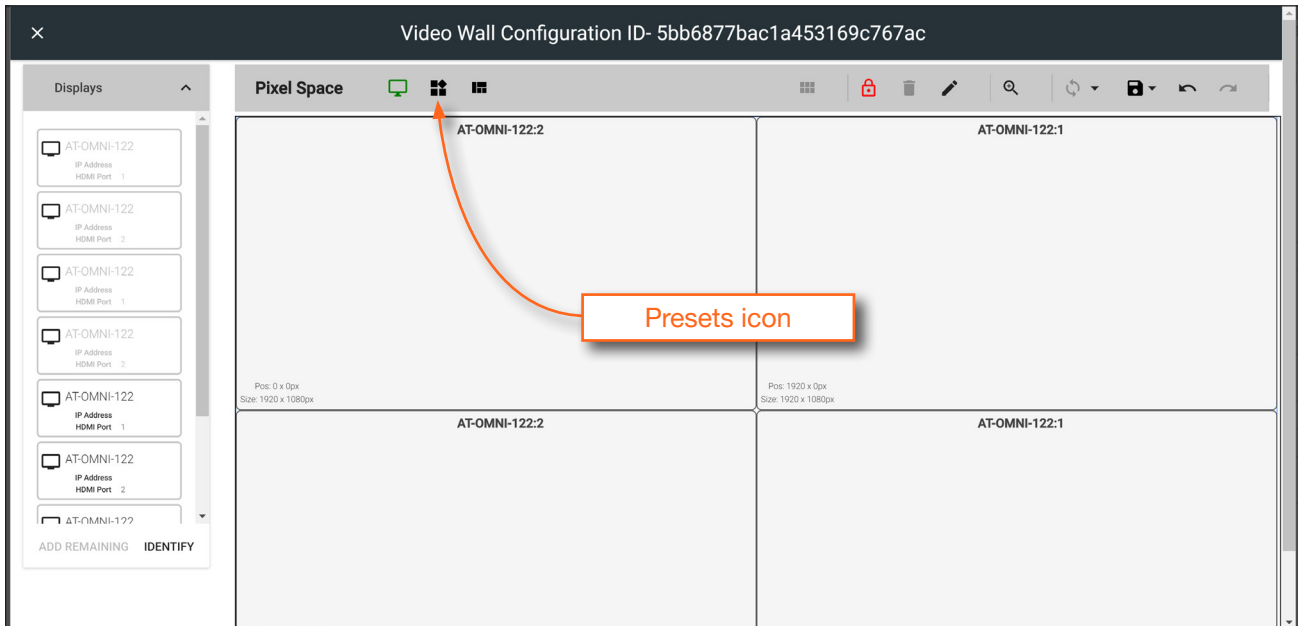

2. Click **Add**, under **Presets**.

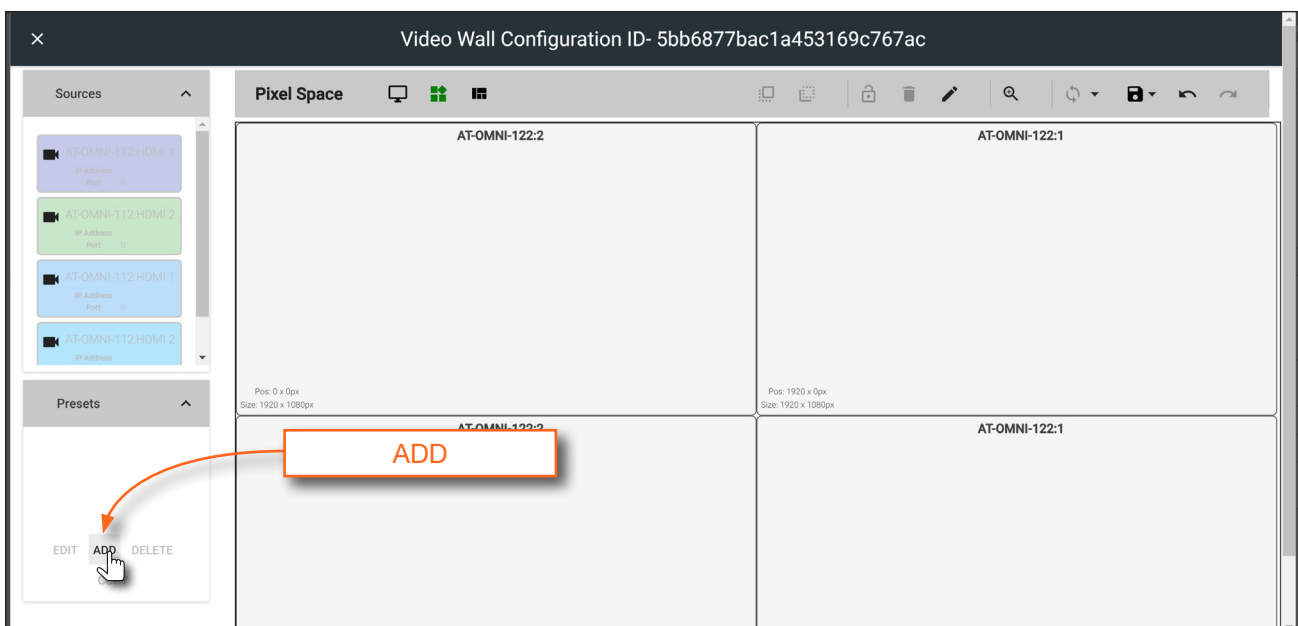

3. Enter the name of the preset in the **Preset Edit** dialog.
4. Click the **CLOSE** button to save the preset name and dismiss the dialog.



5. Under the **Sources** window, on the left side of the screen, drag and drop the desired source(s) to each display in the **Pixel Space** window. Note that more than one source can be mapped to each display. For example, in the illustration below, the AT-OMNI-512 (225.0.0.19, port 1000) has been mapped to both Left Display 2 (upper-left corner) and Left Display 1 (lower-right corner).

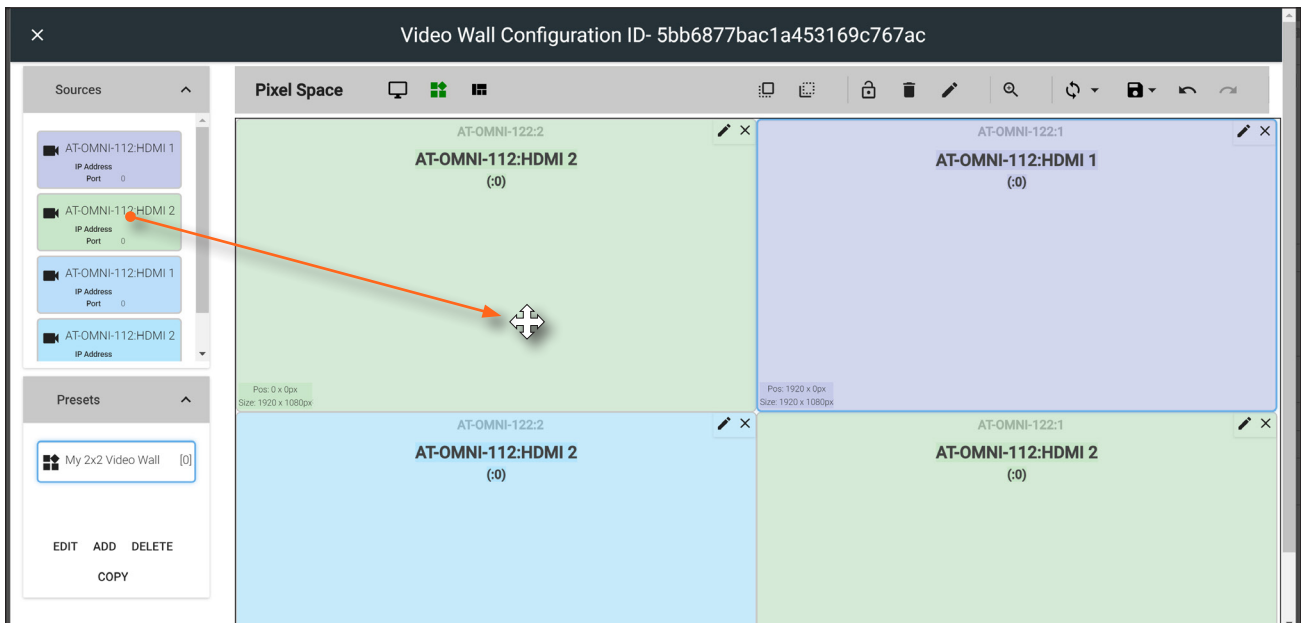

Preset Orientation

There may be some situations in which content that is spread across multiple displays must be rotated. Two examples are shown below.

Example 1: Content requiring rotation.

In the following example, a single source is spread across three vertical displays. The source content (shown on the left) is rotated -90 degrees. In order for the content to be displayed correctly, the source must be rotated.

Figure 1.1 - Source content



Figure 1.2 - Source content properly rotated to span three vertically rotated displays.

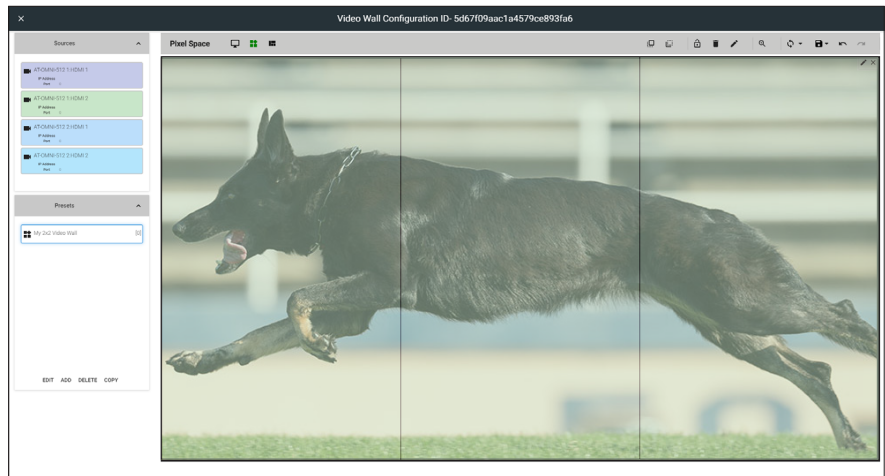

1. Click the  icon in the upper-right corner of the screen. The source dialog will be displayed.
2. Locate the **Disable Rotation** toggle switch at the bottom of the dialog.
3. Verify that the toggle switch is set to the far-left position. The toggle switch will be gray when rotation is *enabled*.
4. Click **CLOSE** to commit changes and dismiss the dialog box.

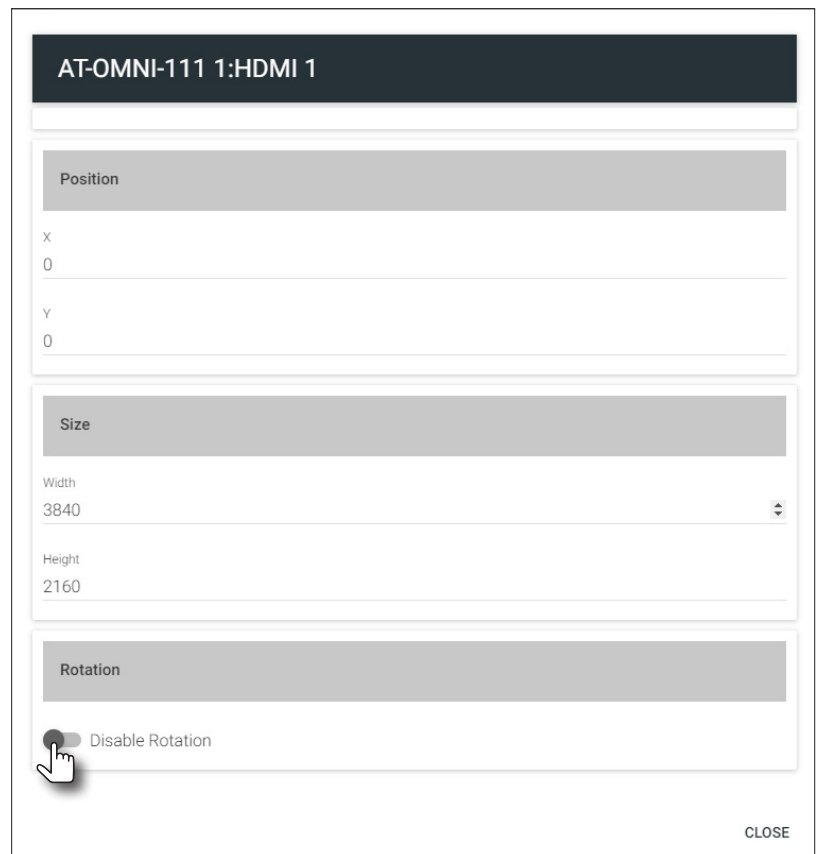

Example 2: Content that does not require rotation.

In this example, three sources are spread across three vertical displays. The content (shown on the left) was created to be displayed horizontally. In this case, rotating the source is not required.

Figure 1.1 - Source content

Source 1

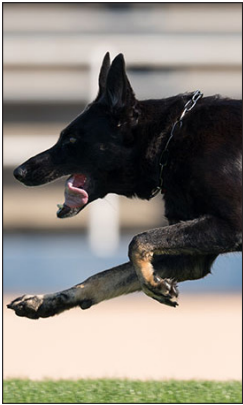

Source 2

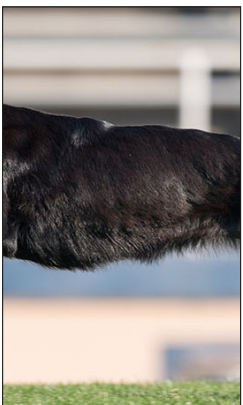

Source 3

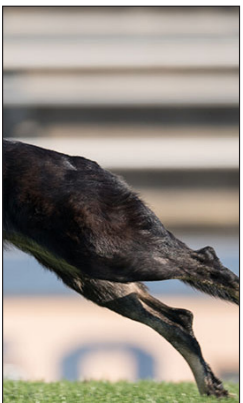
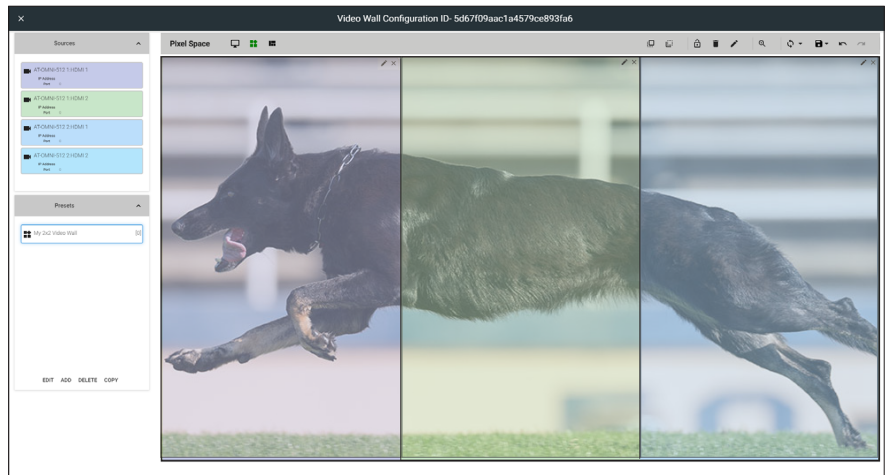

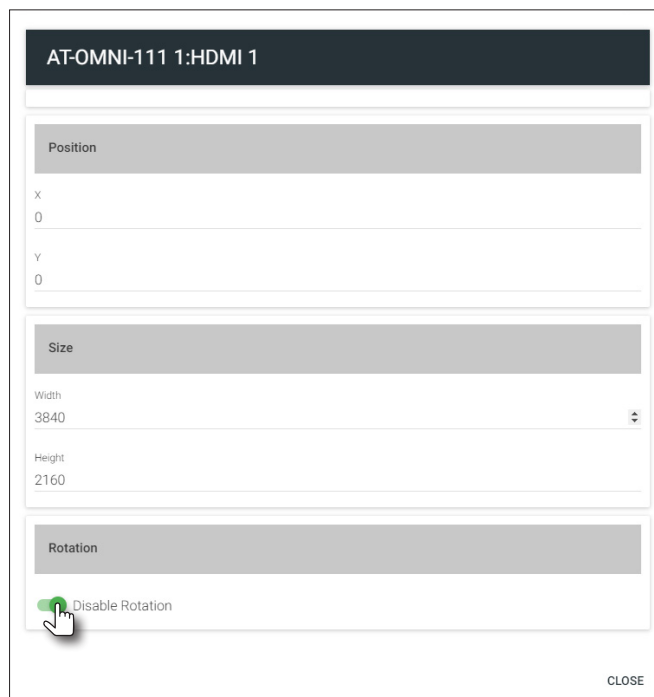

Figure 1.2 - Source content properly rotated to span three vertically rotated displays.



1. Click the  icon in the upper-right corner of the source window. The source dialog will be displayed.
2. Locate the **Disable Rotation** toggle switch at the bottom of the dialog.
3. Verify that the toggle switch is set to the far-left position. The toggle switch will be green when rotation is *disabled*.
4. Click **CLOSE** to commit changes and dismiss the dialog box.
5. Repeat steps 1 through 4 for each source.



Sources can also be re-sized “on the fly” to achieve the desired presentation. Refer to the illustration below. To re-size a source, click and drag the source window horizontally, vertically, or diagonally. Release the mouse to commit the changes. Refer to the *Atlona Velocity User Manual* for more information on manipulating source windows.



NOTE: When source windows are resized, they will “snap” to the nearest vertical or horizontal border, depending upon the direction that the mouse cursor is being moved. Source windows cannot occupy fractions of a display window.

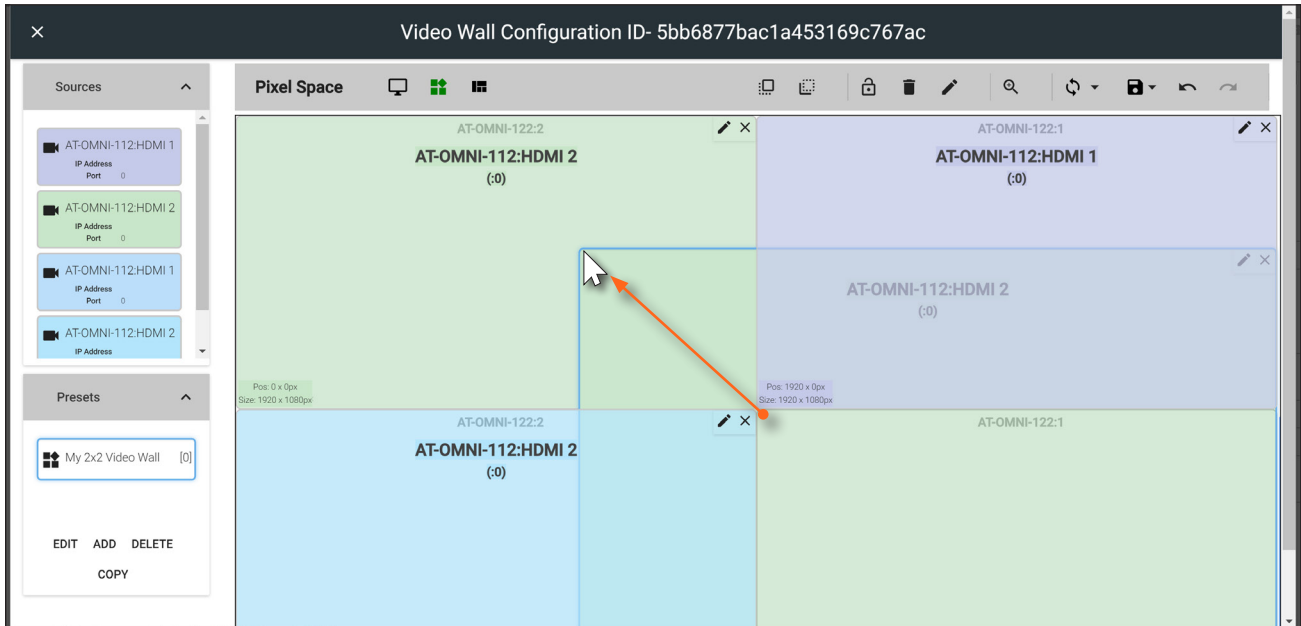

6. Click **ADD**, under the **Presets** section, on the left side of the screen, to create additional presets.
7. Repeat steps 3 through 5 to create the preset. Once the desired presets have been created, click the preset name under the Presets section to recall it. The video wall will be updated with the selected preset.

Refer to the *Atlona Velocity User Manual* for more information on using and recalling presets.

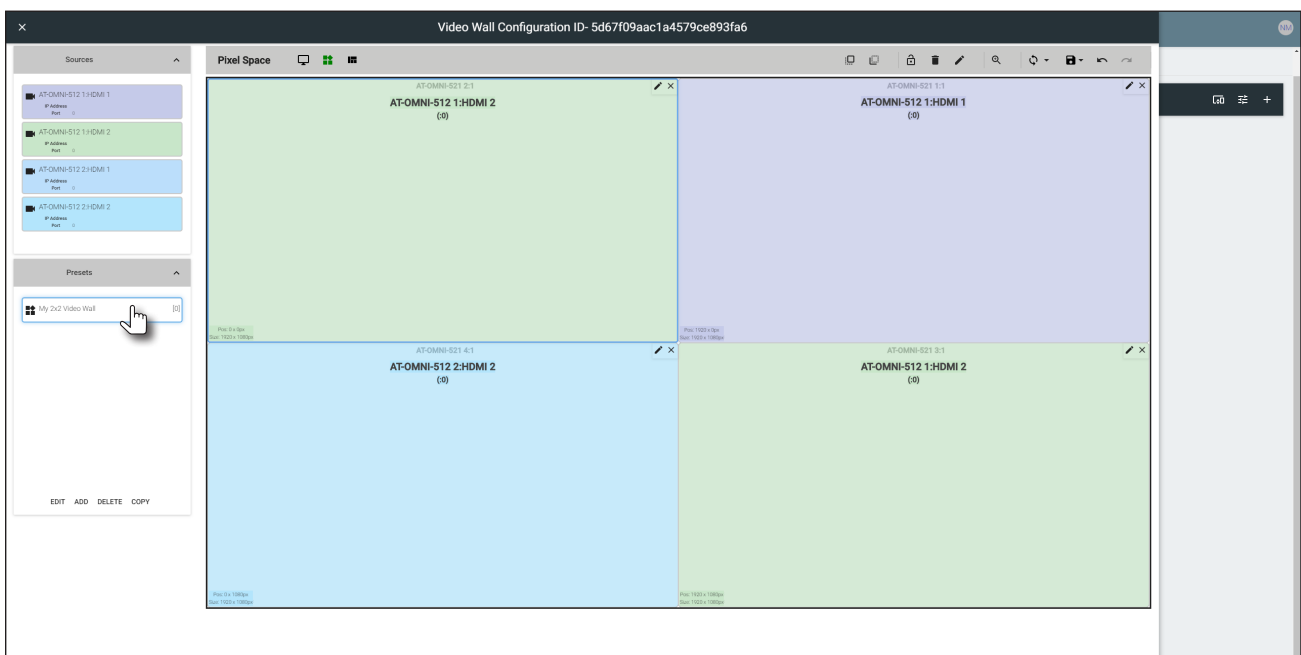

Creating and Using Drop Zones

Drop Zones are “containers”, allowing sources to be placed (“dropped”) in real-time on a video wall. Drop Zones are similar to presets, except that unlike presets, Drop Zone content can be changed on-the-fly within the Video Wall Control Screen.

1. Populate the **Pixel Space** window with the desired devices.
2. Click the **Lock Displays** icon to lock the devices in place.
3. Click the **Drop Zones** icon in the **Pixel Space** menu bar.
4. Click **ADD**, under the **Drop Zones** window, on the left side of the screen. This will create the Drop Zone *preset*.

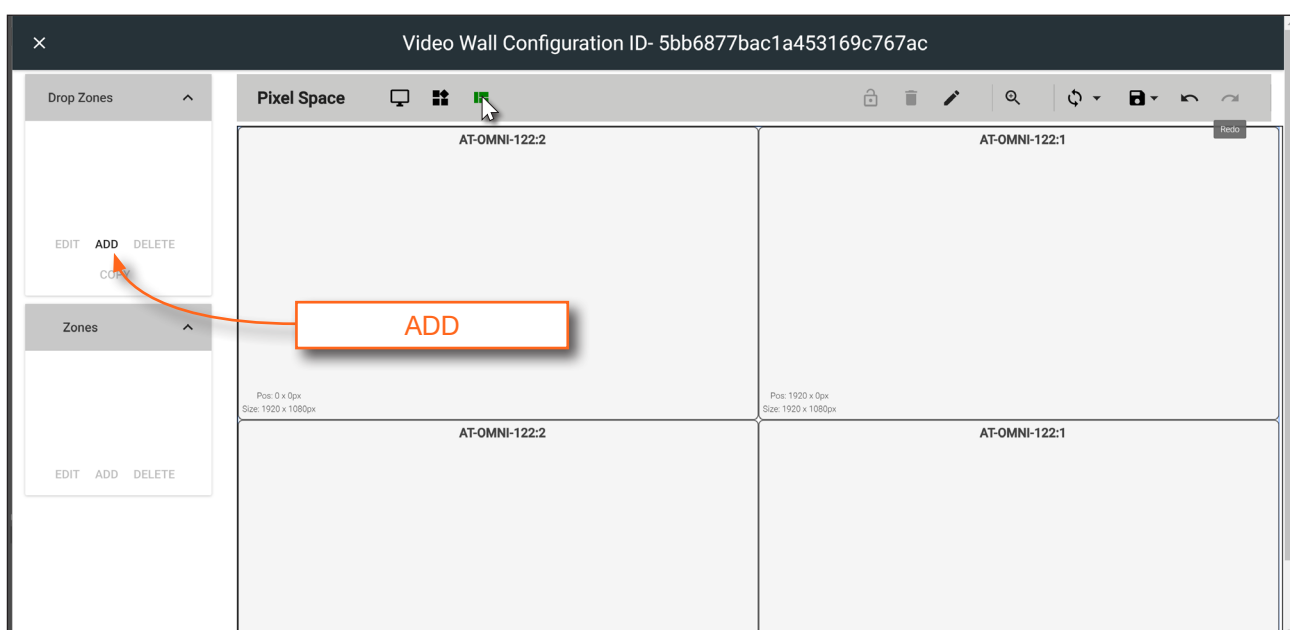

5. Click **EDIT** and provide a name for the Drop Zone in the **Drop Zone Edit** dialog box.
6. Click the **CLOSE** button to commit the change.

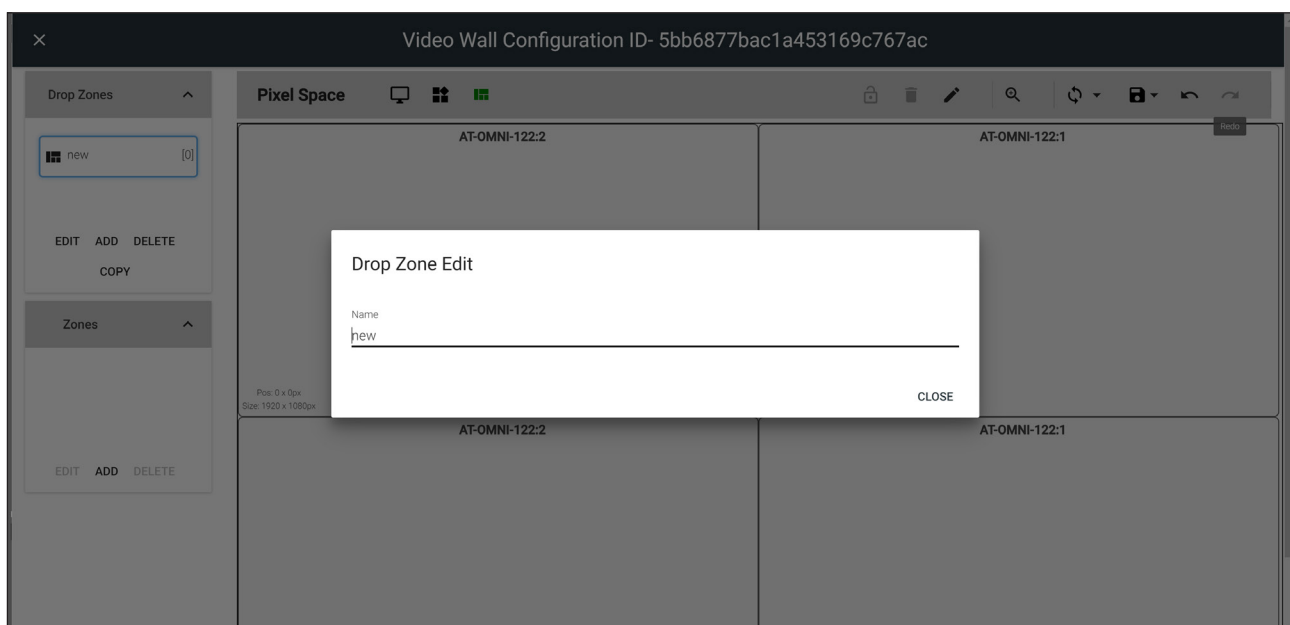

Preset Orientation

There may be some situations in which content that is spread across multiple displays must be rotated. Two examples are shown below.

Example 1: Content requiring rotation.

In the following example, a single source is spread across three vertical displays. The source content (shown on the left) is rotated -90 degrees. In order for the content to be displayed correctly, the source must be rotated.

Figure 1.1 - Source content



Figure 1.2 - Source content properly rotated to span three vertically rotated displays.

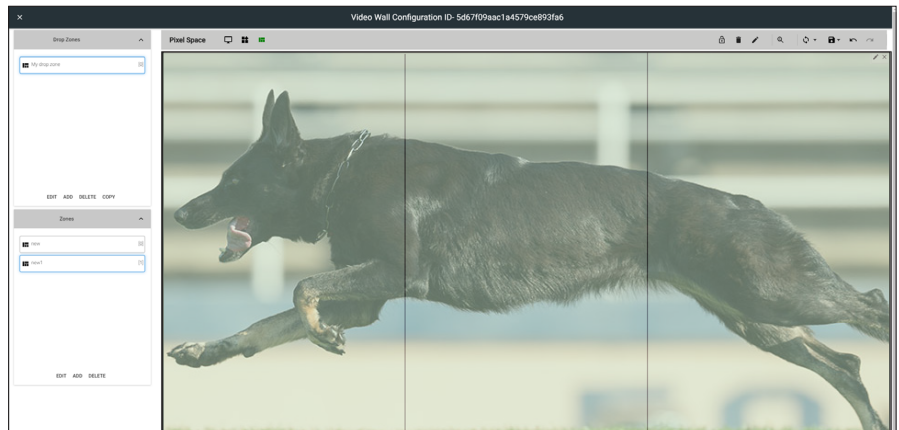

1. Click the  icon in the upper-right corner of the screen. The **Edit Zone** dialog will be displayed.
2. Locate the **Disable Rotation** toggle switch at the bottom of the dialog.
3. Verify that the toggle switch is set to the far-left position. The toggle switch will be gray when rotation is *enabled*.
4. Click **CLOSE** to commit changes and dismiss the dialog box.

Edit Zone

Name
hew

Position

X
0

Y
0

Size

Width
3840

Height
2160

Rotation

Disable Rotation

Example 2: Content that does not require rotation.

In this example, three sources are spread across three vertical displays. The content (shown on the left) was created to be displayed horizontally. In this case, rotating the source is not required.

Figure 1.1 - Source content

Source 1

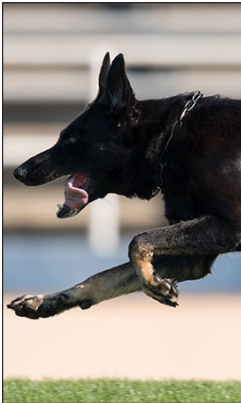

Source 2

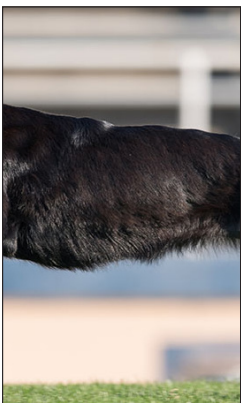

Source 3

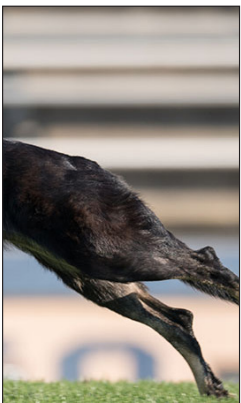
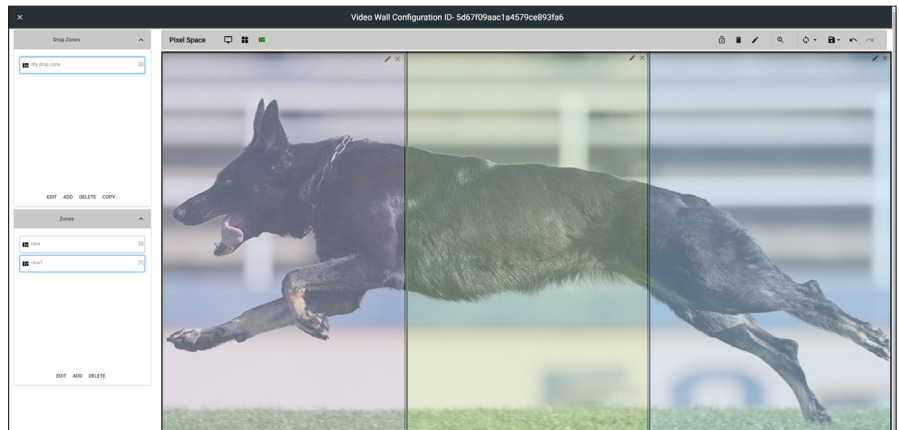

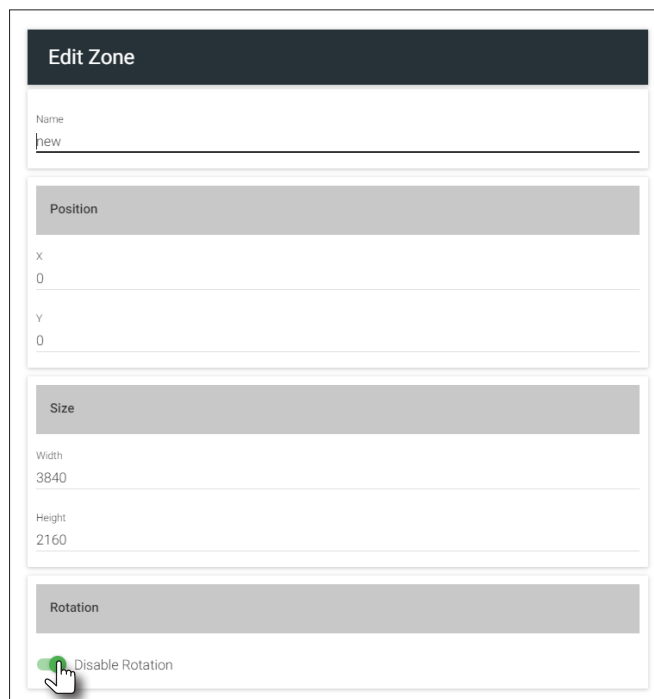

Figure 1.2 - Source content properly rotated to span three vertically rotated displays.



1. Click the  icon in the upper-right corner of the source window. The **Edit Zone** dialog will be displayed.
2. Locate the **Disable Rotation** toggle switch at the bottom of the dialog.
3. Verify that the toggle switch is set to the far-left position. The toggle switch will be green when rotation is *disabled*.
4. Click **CLOSE** to commit changes and dismiss the dialog box.
5. Repeat steps 1 through 4 for each source.



7. Click **ADD**, under the **Zones** window.

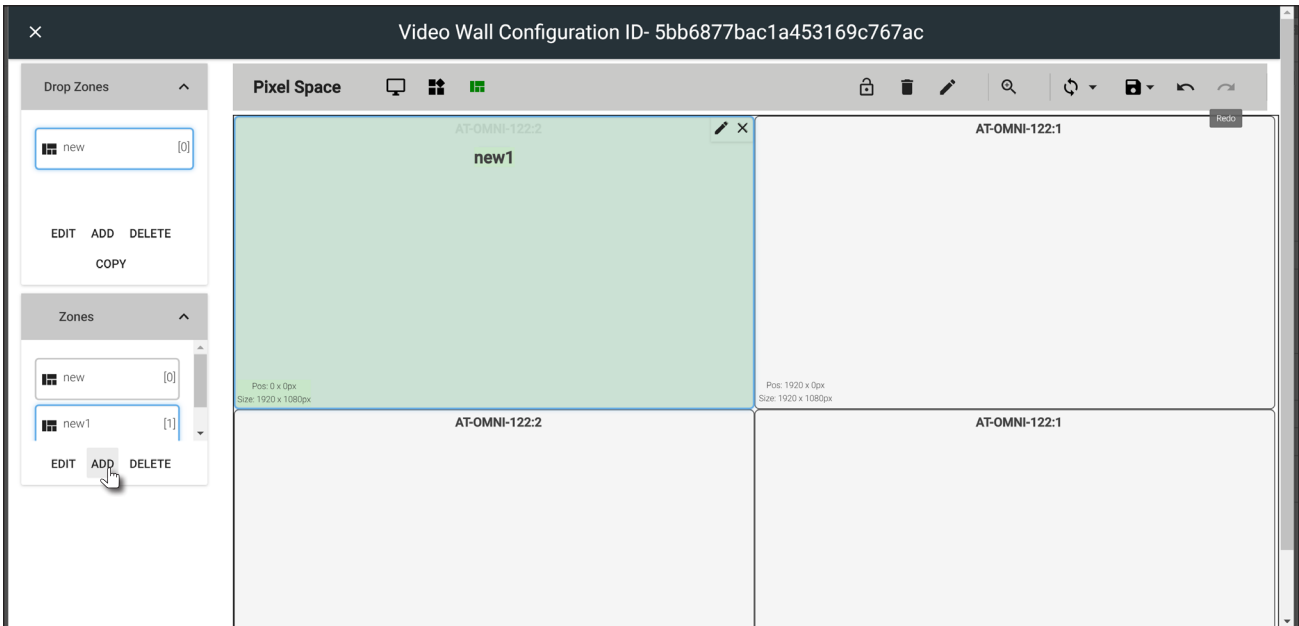

8. Click **EDIT** and provide a name for the Zone, in the **Edit Zone** dialog box. Click **Close** to save the change.

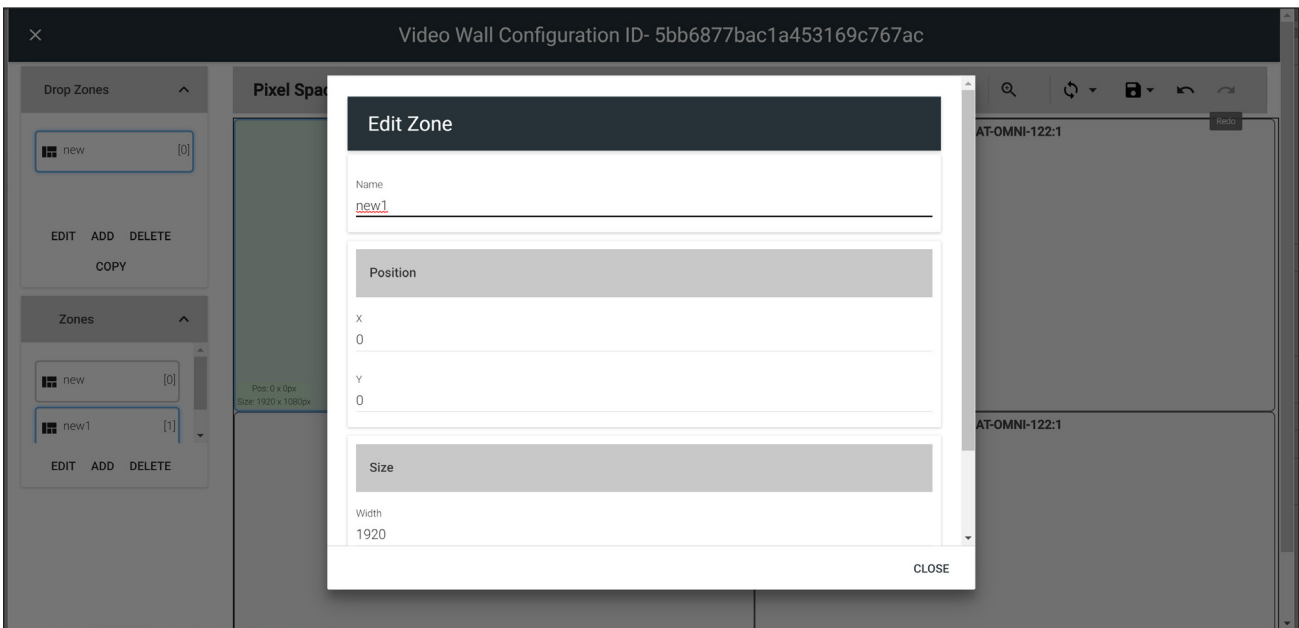

Note that each time the **ADD** button is clicked, a new Drop Zone *container* is created. In this first example, two Drop Zone containers are created. When adding containers, note that the position of each container is created in the same position, within the **Pixel Space** window.

- Drag each container to the desired area on the video wall. To place a container on each device, left-click and drag, then release when a majority of the window is placed over the device.

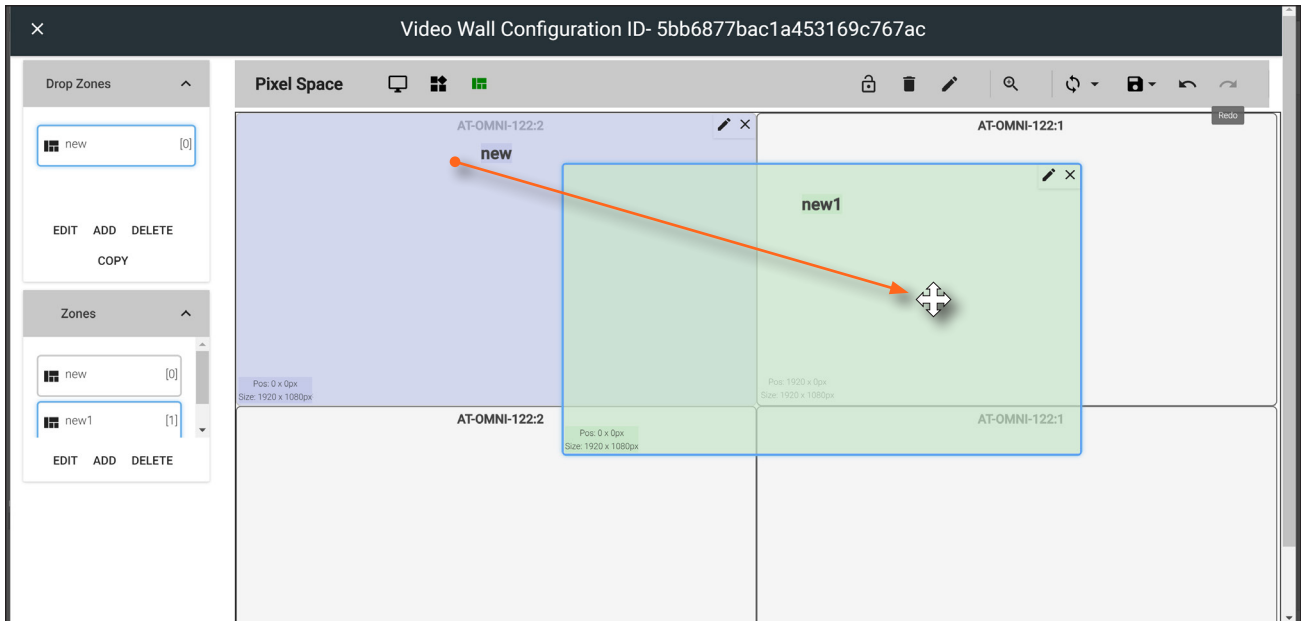

If a container is positioned over the intersection of two windows, then it will automatically be resized to accommodate both devices, as shown below. If placed over the corner intersection of more than two windows, then the container will be resized to cover all devices occupying that space.

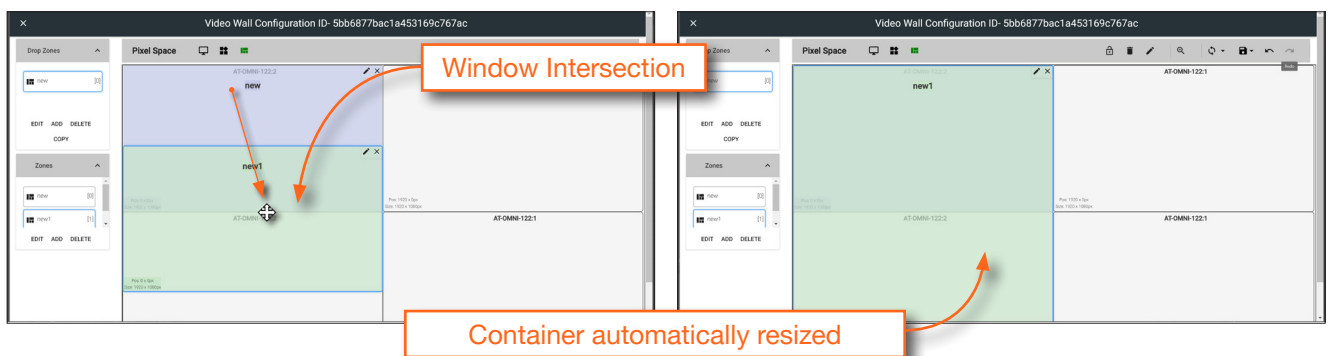

- Click the **Lock Preset** button, once the containers have been placed in the desired positions.

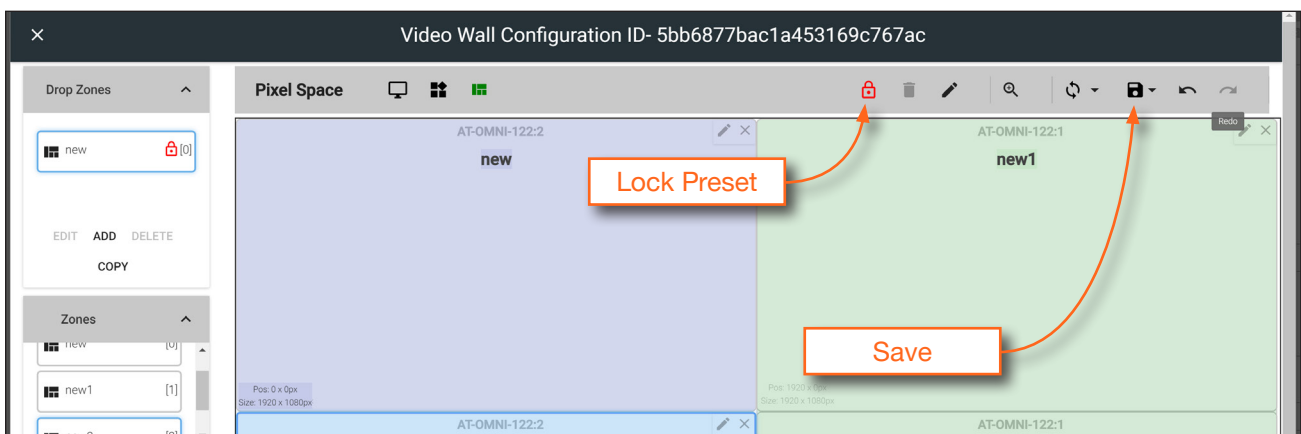

11. Repeat the above steps to create additional Drop Zone presets. Each Drop Zone preset can have a different number of containers. However, the number of containers that are created should not exceed the number of devices within the **Pixel Space** window.
12. Click the **Save** icon to commit all changes.
13. Close the **Video Wall Configuration** window, by clicking the **X**, in the upper-left corner of the screen.



14. Click the **Launch Control** icon, in the far-left corner of the **Modify Room** screen.

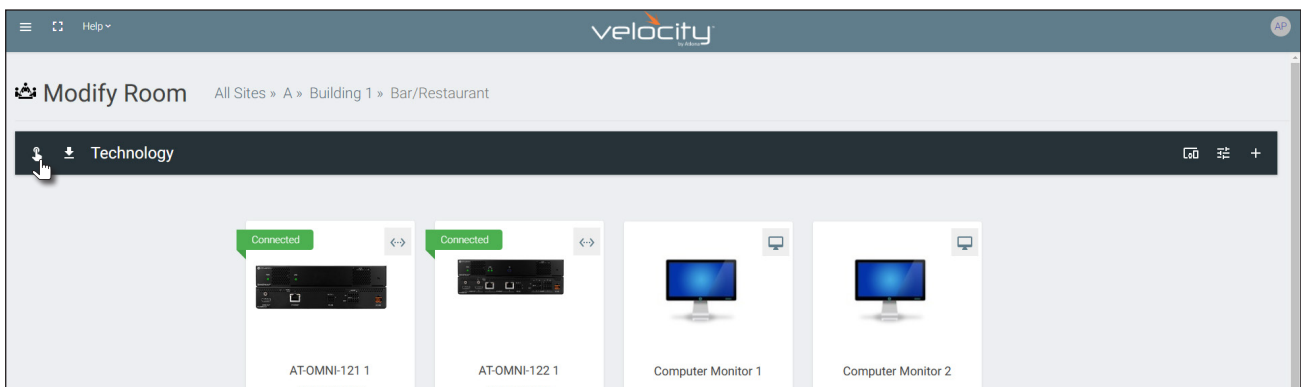

15. Click the **VIDEO WALL** icon.

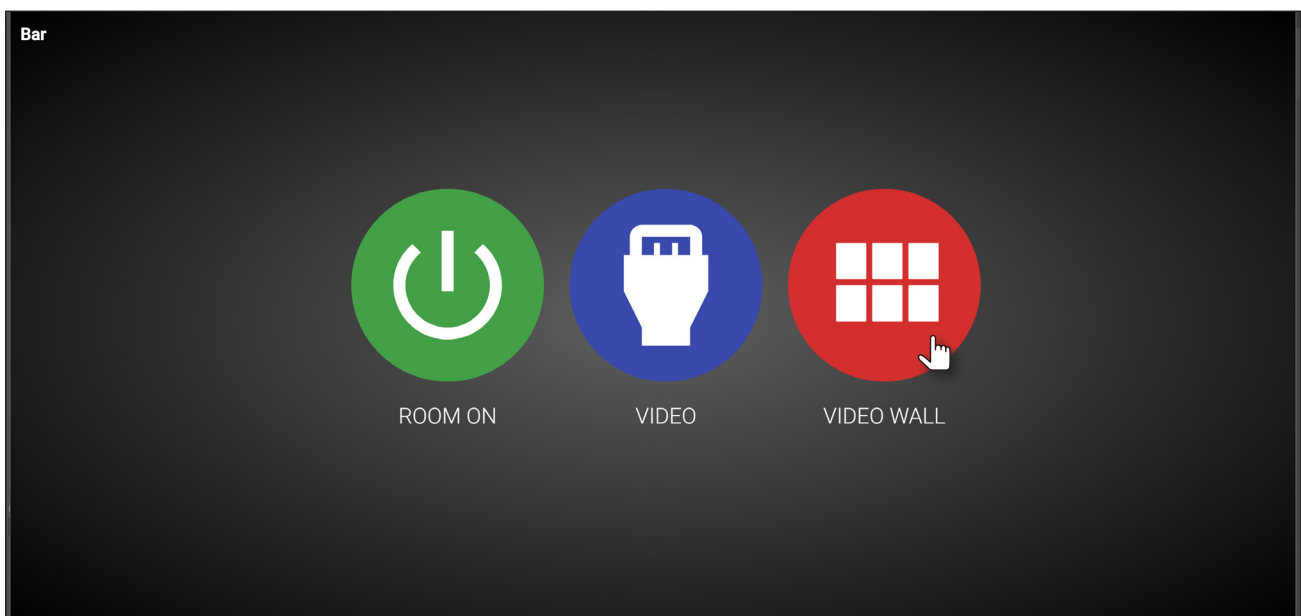

16. The **Presets** portion of the control screen will be displayed. All presets that were created, will be listed on the left-hand side of the screen, as shown below. Note in this example, only one preset was created. Click the desired preset to recall it.



17. Click **Zones**, in the lower-left corner of the screen to access the Drop Zones, which were created earlier. In the example example below, two Drop Zones were created.

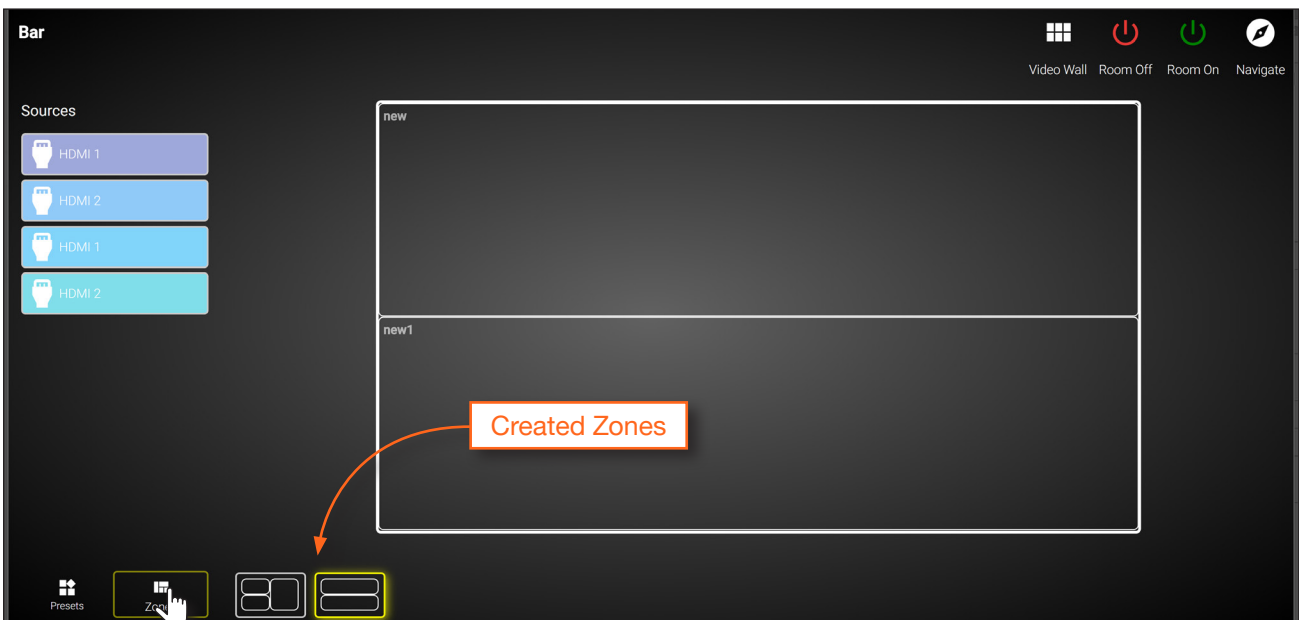

The first Drop Zone that was created, shows two containers on the left, and a single container on the right. The second Drop Zone, only uses two containers: one on the top and one on the bottom. The Preset which we created is a 2x2 video wall and represents the physical layout of the displays. Drop Zones are containers and act as a “map” to where the video sources will be applied. Refer to the next page for an example.

The first Drop Zone will can dynamically apply sources to the preset, which is a 2x2 video wall, to the top-left, bottom-left, and both or only one display(s) on the right-hand side. Some possible combinations are shown below. Drop Zone containers have been labeled alphabetically, for reference.

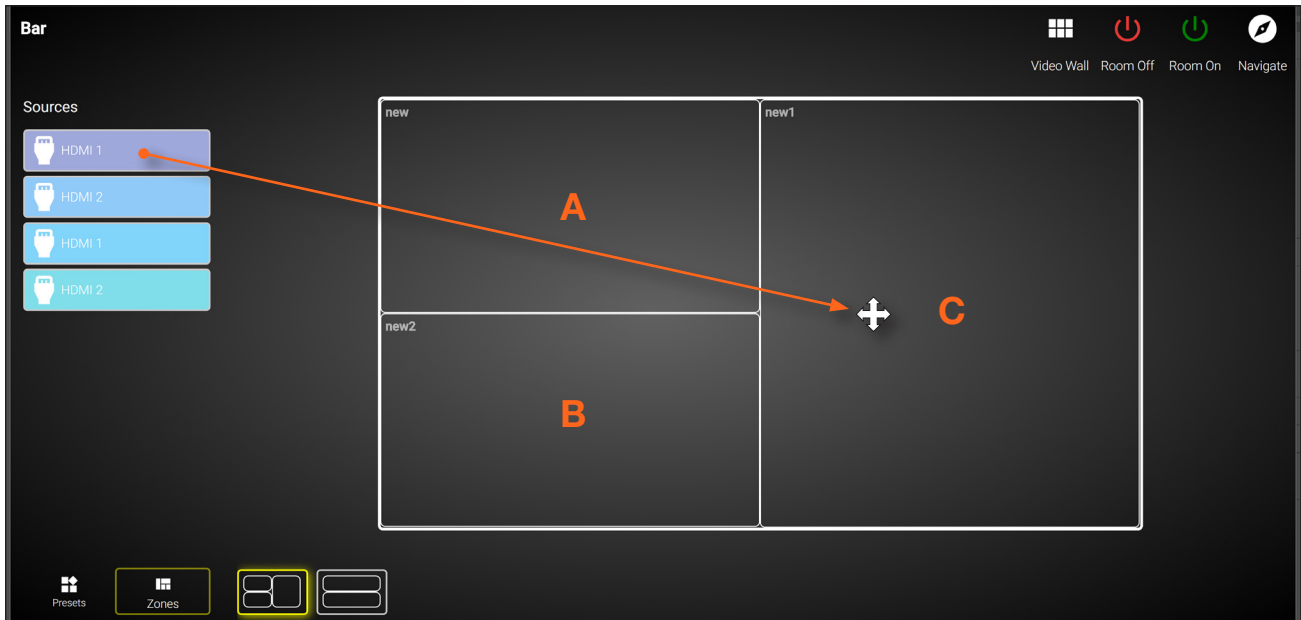

Note that although the top-right and bottom-right displays are physically separate, dragging and dropping a source from the left-hand side of the screen to Drop Zone container “C”, will “map” the source to both displays.

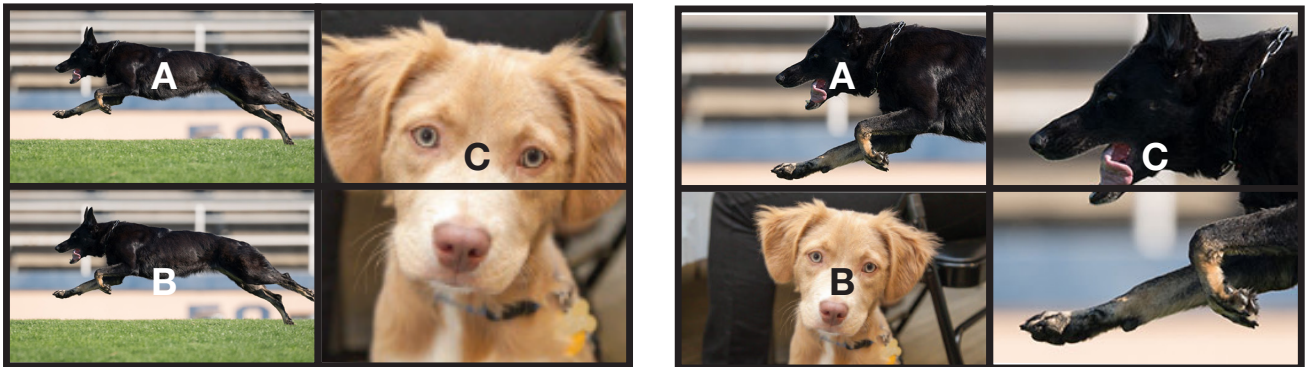

To change to a different source, drag and drop a source from the left-hand side of the screen to the source to be replaced.

Custom Drop Zones

In addition to creating user-defined Drop Zones, the Velocity Video Wall also includes a Custom Drop Zone. This unique type of Drop Zone allows dynamic re-sizing of sources to be mapped across any of the decoders.

1. Return to the **Video Wall Configuration** screen and click the **Pixel Space** icon, in the **Pixel Space** menu bar.

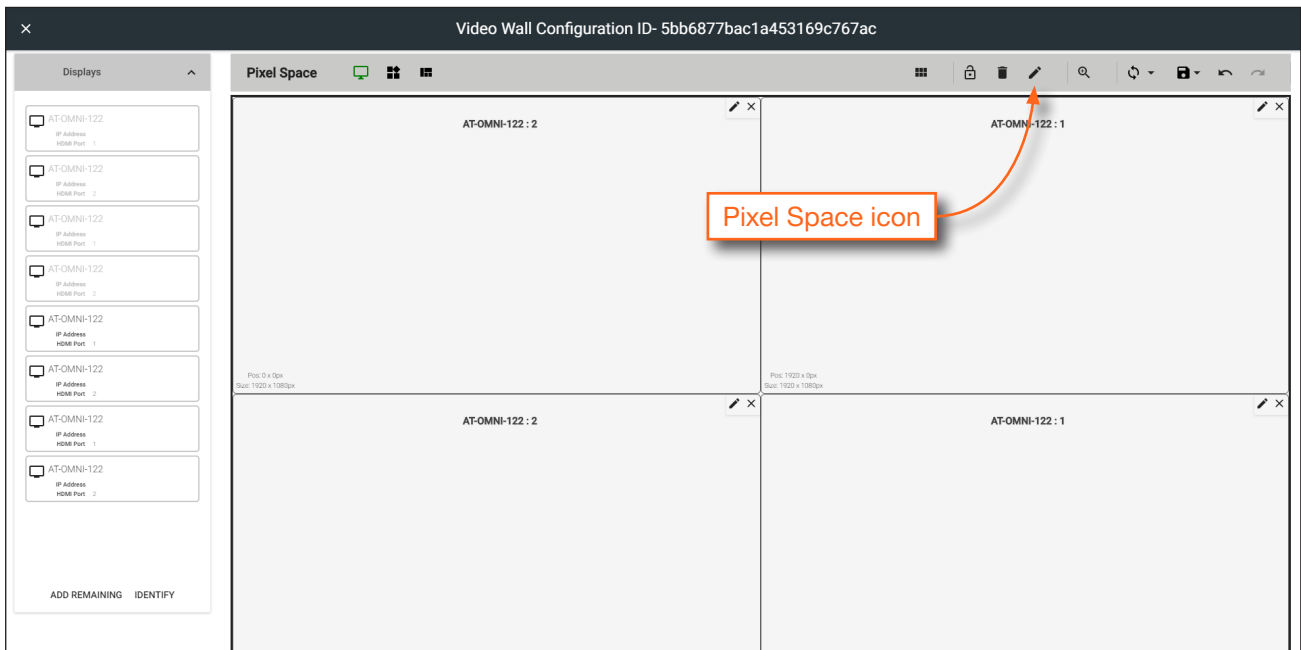

2. Click the **Allow custom drop zone** toggle switch to enable it. When enabled, this toggle switch will be green.

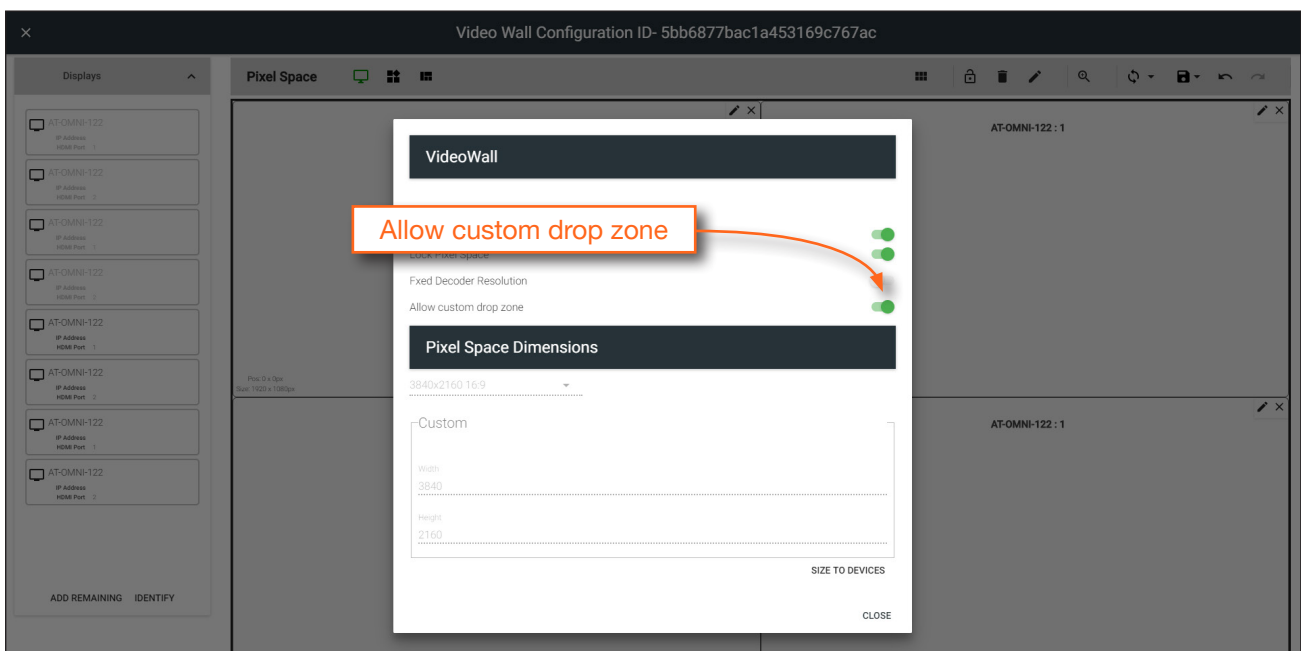

3. Click **CLOSE** to save changes and dismiss the dialog box.
4. Click the **Save** icon in the top-right portion of the **Video Wall Configuration** screen to commit changes.

5. Close the **Video Wall Configuration** screen and then click the **Launch Control** icon on the **Modify Room** screen.
6. Click the **VIDEO WALL** icon to enter video wall control screen.
7. Click **Zones** at the bottom of the screen, then click the **Custom Drop Zone** icon.

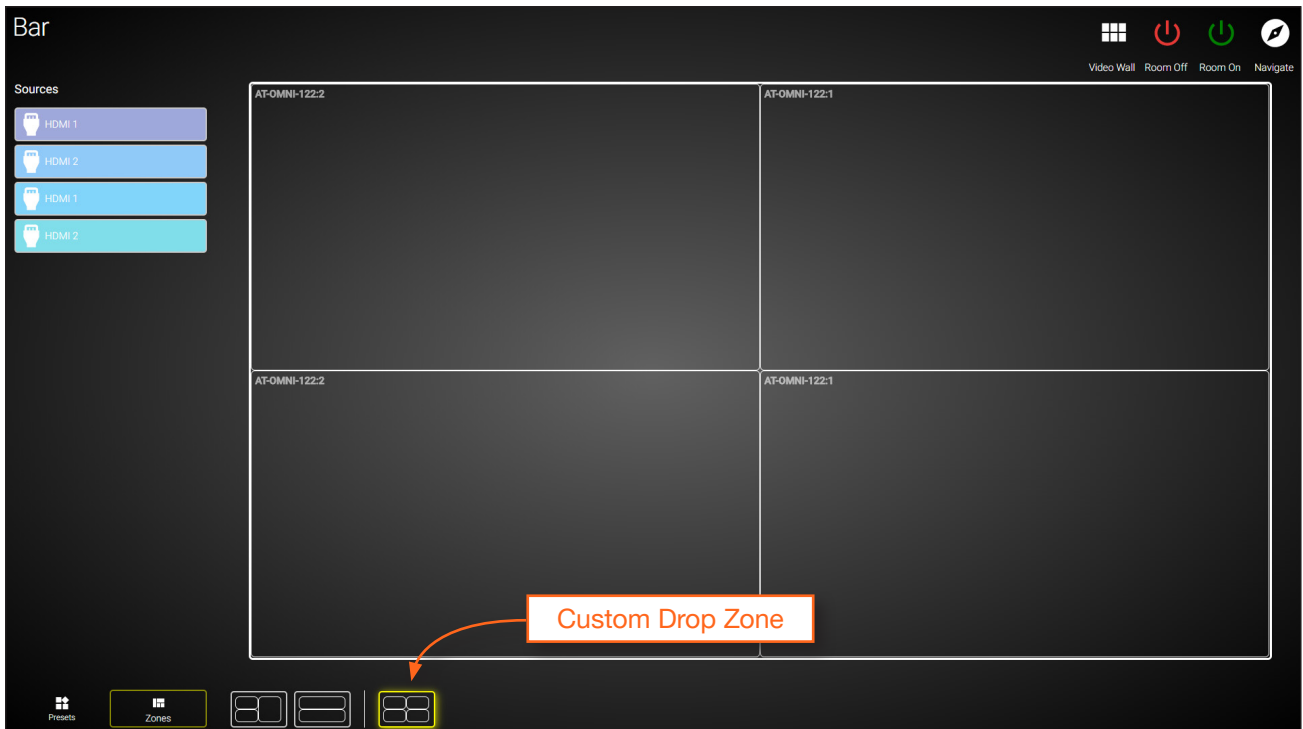

8. Drag-and-drop sources from the left side of the screen, as performed with normal Drop Zones.

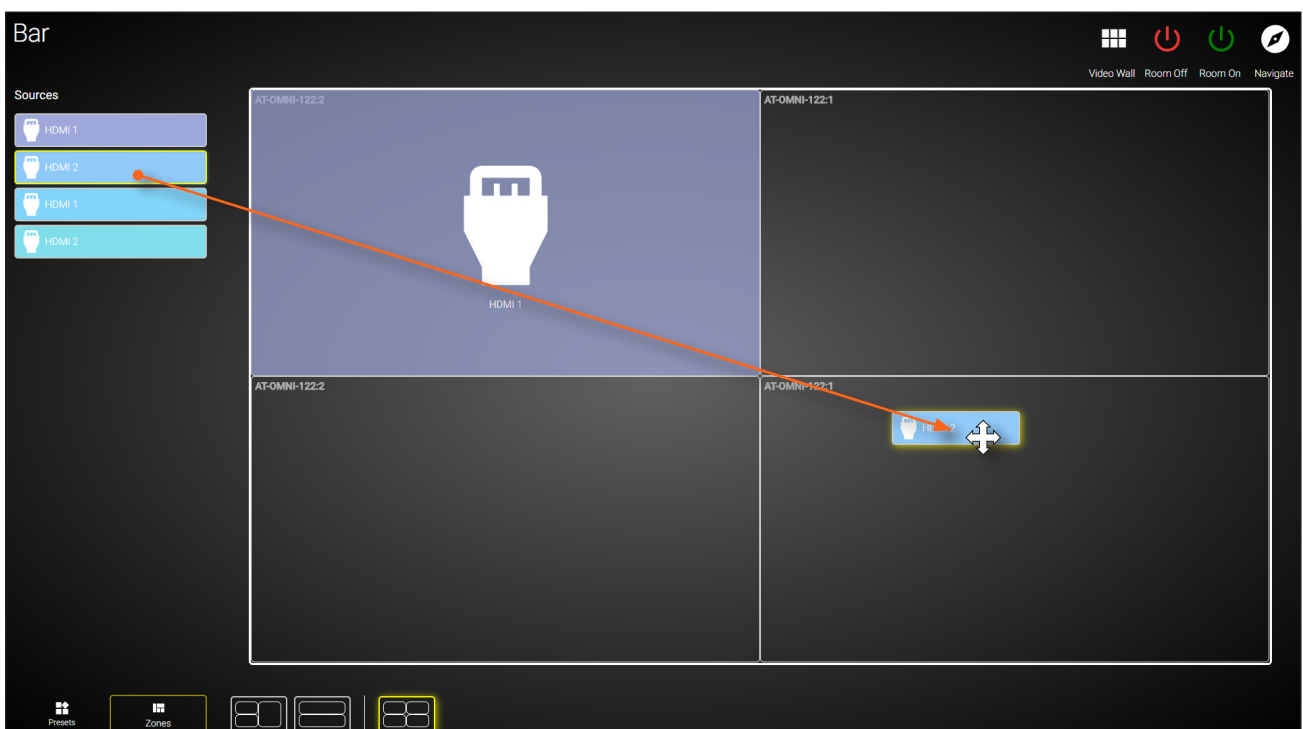

9. Resize or reposition windows by clicking and dragging the edges of each source, horizontally / vertically, to the desired area of a container.

To reposition the source to a different container(s), click in the middle of a source, then drag and drop to the desired container(s).

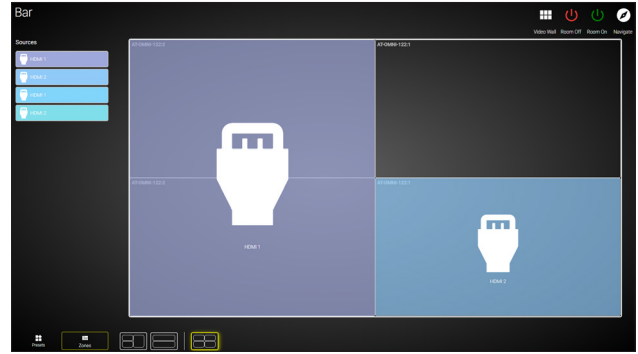
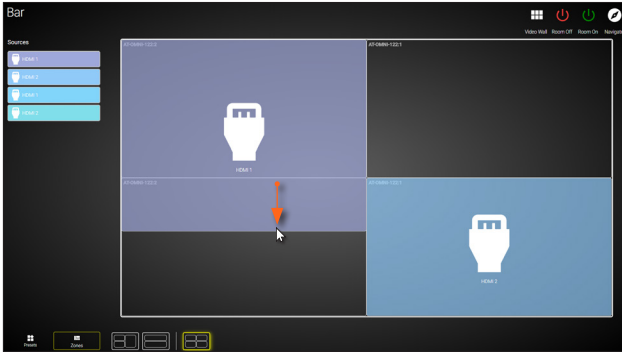

If the source is dropped at the intersection of two containers, the source will automatically be resized to fill both containers. In the example below, the source will be displayed on all four screens.

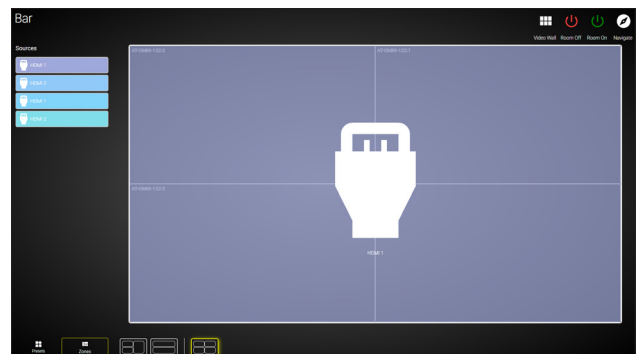
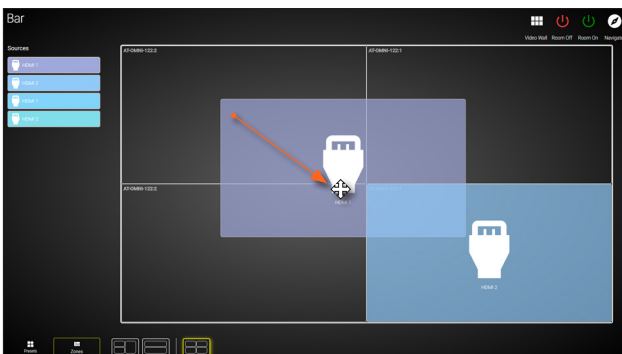

The AMS Interface

Device Info page

The **Device Info** page provides general information about the decoder. The encoder has an identical interface.

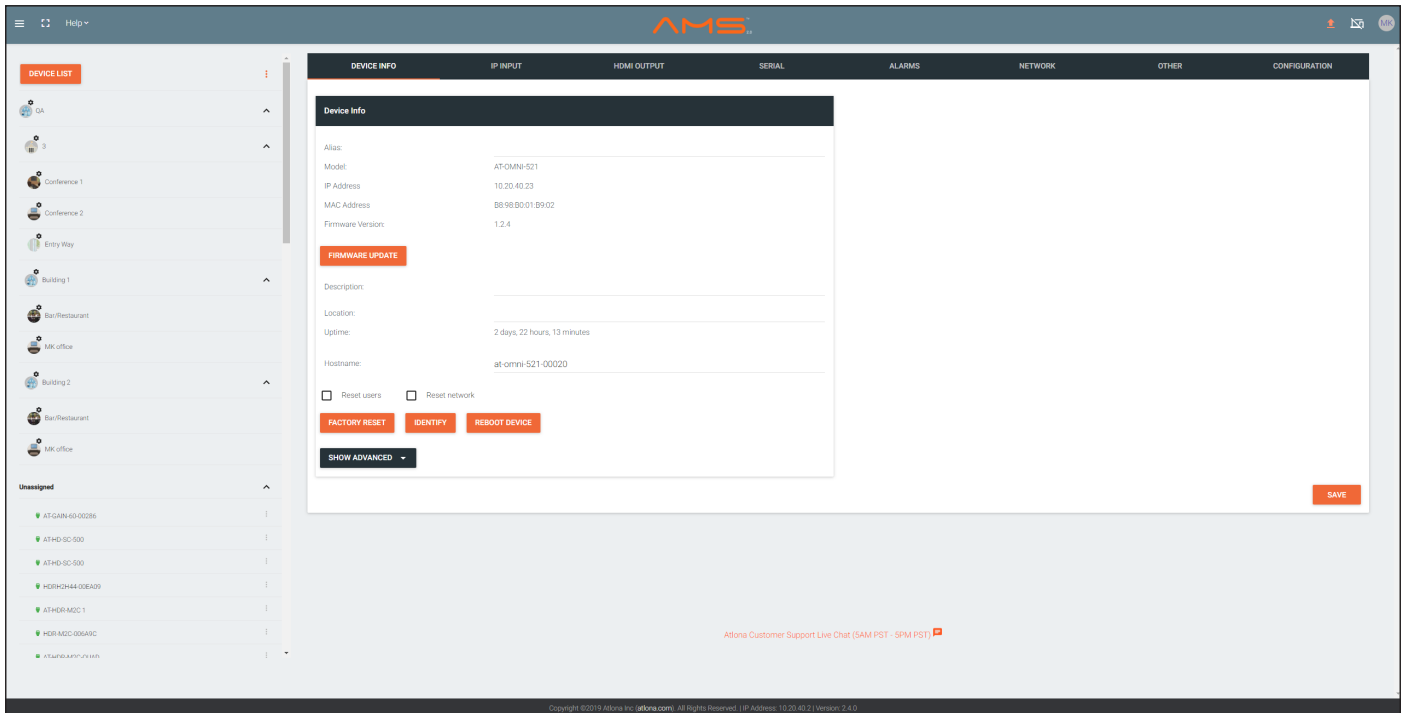

Alias

Enter a name for the unit in this field. This is optional.

Model

The model number of the unit.

IP Address

Displays the IP address of the decoder.

MAC Address

Displays the hardware MAC address of the decoder.

Firmware version

The version of firmware that the encoder is running. Always make sure the latest version of firmware is installed.

FIRMWARE UPDATE

Click this button to update the firmware.

Description

Provides the option of assigning descriptive name to the unit.

Location

Provides the option of assigning descriptor for the location of the unit.

Uptime

Time elapsed since the last reboot operation.

Hostname

The hostname of this unit. This can be changed if desired. By default, the host name is automatically created using the model of the unit and adding the last five digits of the unit serial number.

FACTORY RESET

Click this button to reset the encoder to factory-default settings. When performing a factory reset, the following options can be selected, by clicking the check box. If no options are selected, then the encoder is reset with no factory-default settings.

Option	Description
None Checked	Resets the decoder with no factory-default settings.
Reset User	Resets the decoder to factory-default settings and resets custom user information.
Reset Network	Resets the decoder to factory-default settings and resets network information.
Reset Defaults	Resets the decoder to factory-default settings. In addition, static multicast addresses are configured. This option can be used to configure a single encoder to transmit to any number of decoders without using the Virtual Matrix within AMS.  IMPORTANT: This option will not work for multiple decoders on the same network.

IDENTIFY

Click this button to physically identify a unit on the network. Clicking this button will cause all front-panel LED indicators to flash for 10 seconds.

REBOOT DEVICE

Click this button to perform a soft reboot of the encoder.

Advanced Settings

Click the **SHOW ADVANCED** button to view the following options.

Timezone

Click this drop-down list to select the time zone, expressed in Universal Coordinated Time (UTC).

System Temperature

The current internal temperature of the unit listed in both degrees Fahrenheit and Celsius.

Die Temperature

The component chip temperature listed in both degrees Fahrenheit and Celsius.

Power Consumption

The current power consumption value.

Dolby Vision License Enabled

This indicator will be green if the Dolby Vision license is installed.

Dolby Vision License Key

Enter the license key in this field, then press the **SAVE LICENSE** button.

SAVE LICENSE

Click this button to activate a valid Dolby License key.

NTP Server

Specify the desired NTP server in this field. This provides timestamps for any logs and alarms.

Buttons

Disabling this feature will lock the ID button on the front panel. This feature is enabled by default.

LEDs

Disabling this feature will turn off all LED indicators on the front panel. This is enabled by default.

IP Input page

The **IP Input** tab provides configuration of each input, the assigned multicast address(es), and ports.

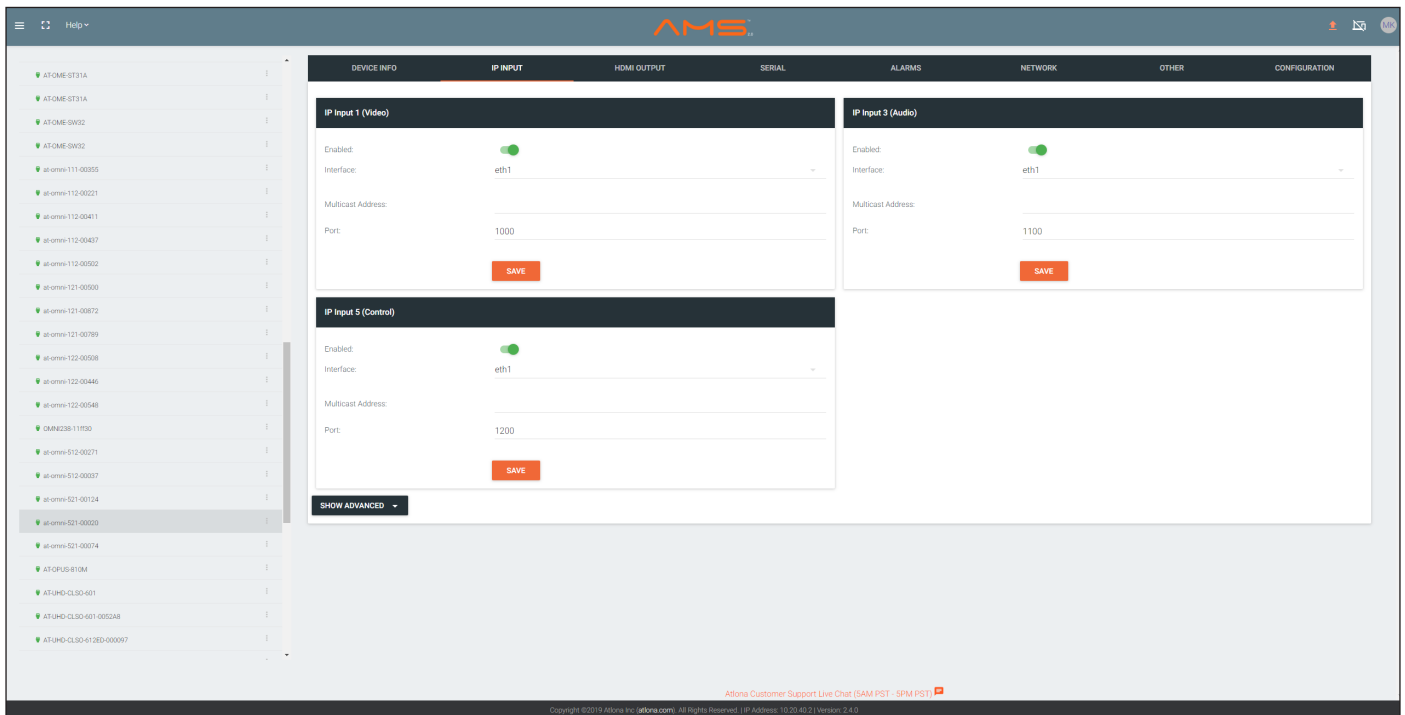

Enabled

Click this checkbox to enable the IP input.

Interface

The physical interface that will be used to carry the multicast traffic. The only available selection is **eth1**.

Multicast Address

Enter the multicast address of the decoder stream.

Port

Enter the multicast UDP listening port in this field.

Advanced Settings

The following settings are related to IGMPv3 multicast filtering. IGMPv3 provides support for source-specific multicast devices. For example, the receiver of a multicast group can specify a set of addresses to which it can subscribe (include mode) or not subscribe (exclude mode).

Mode (IGMPv3 only)

Click this drop-down list to select the mode. Mode can be set to exclude or include and is specifically used when using Source Specific Multicast (SSM). SSM will only function if the network is properly set up to support it.

Mode	Description
exclude	Multicast content coming from the source mentioned in the Addresses section will be excluded (blocked).
include	Multicast content coming from the source mentioned in the Addresses section will be included, and allowed to be passed to the decoder.

Addresses

Enter the IPv4 address of the encoder(s) in this field and is used as the SSM include/exclude list. Use the comma delimiter to separate multiple IP addresses. When using non-SSM networks, this field is ignored.

HDMI Output page

The **HDMI Output** tab provides options to configure the output streams.

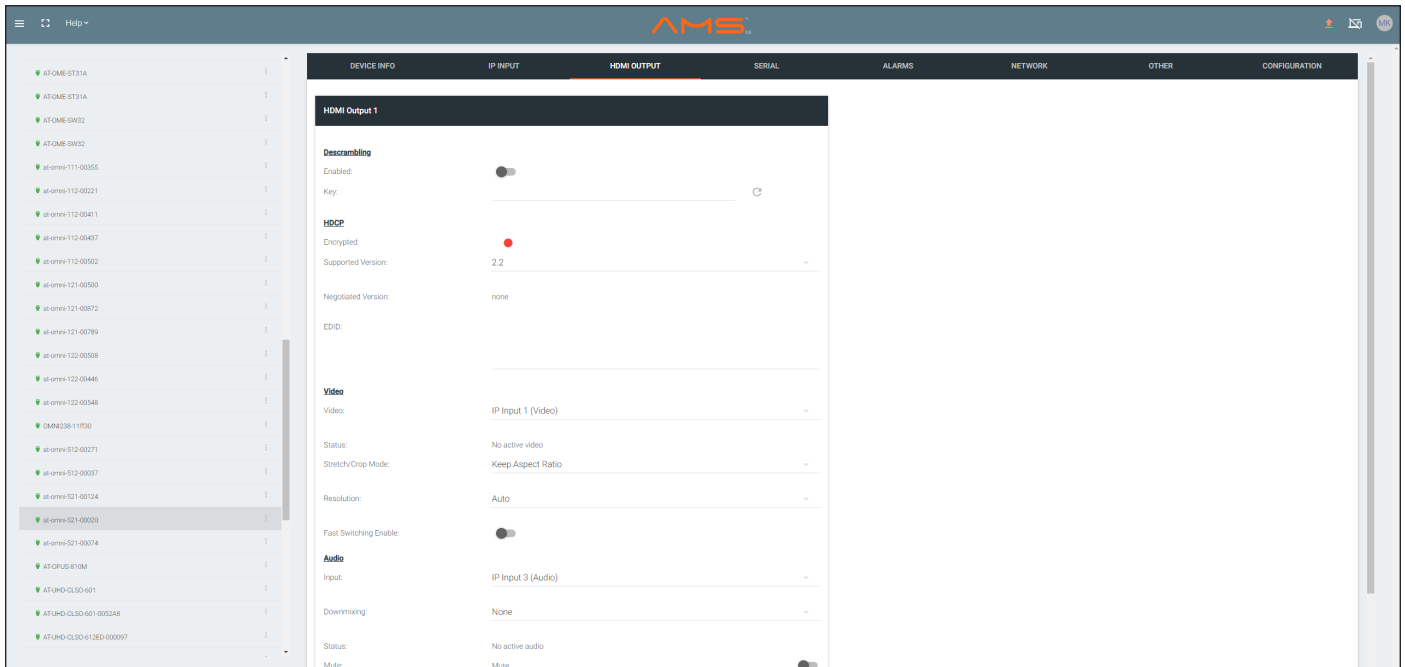

Enabled

Click this toggle switch to enable or disable scrambling on the decoder. When enabled, the toggle switch will be green.

Key

Enter the scrambling key in this field. The scrambling key must be ASCII and must contain a minimum of eight characters. Special characters and spaces are not permitted.

Encrypted

Indicates if the content is HDCP-encrypted or not. If true, then HDCP content is being passed in to the decoder and this indicator will be colored green.

Supported Version

Click this drop-down list to select the desired HDCP version. If set to none, then the sink is reported as “non-compliant” and will receive non-HDCP content.

Input	Description
none	The decoder will receive non-HDCP content.
1.4	The decoder will receive HDCP version 1.4 content.
2.2	The decoder will receive HDCP version 2.2 content.

Negotiated Version

The version of HDCP being received.

EDID

This is a read-only field and cannot be modified. The data in this field is the EDID of the display to which the decoder is connected. This EDID data in this field can be copied to the encoder, allowing the source to send AV formats which are supported by the sink (display) device. Refer to the AT-OMNI-512 User Manual for more information.

Video

Click this drop-down list to select the desired primary video input. Select **generator** to use the internal signal generator. Select the **Not Used** option to leave the video input unassigned.

Status

Displays the input status. If no input is active or detected, then this field will display “No active video”.

Stretch / Crop Mode

Click this drop-down list to select the aspect ratio.

Mode	Description
Keep Aspect Ratio	Aspect ratio is preserved; the output on the decoder will be the same as the input on the encoder.
Full Screen	Stretches the image to fill the screen. In some cases this can distort (“stretch”) the image.
16:9	Sets the aspect ratio to 16:9 “widescreen” format, usually associated with HDTV formats.
16:10	Sets the aspect ratio to 16:10 “widescreen” format, usually associated with computer displays and smart devices.
4:3	Sets the aspect ratio to 4:3 “pan-and-scan” format, usually associated with SDTV.

Resolution

Click this drop-down list to select the desired output resolution. This is a scaler feature which can either upscale or downscale the output on the decoder. If **Input** is selected, then no scaling will be applied to the output. Select **Auto** to use the EDID of the sink device to determine the output resolution.

Resolutions	
Input	1440 x 1050
Auto	1440 x 900
4096 x 2160	1280 x 1024
3840 x 2160	1280 x 800
1920 x 1200	1280 x 768
1920 x 1080	1280 x 720
1680 x 1050	1024 x 768
1600 x 900	

Fast Switching Enable

Click this toggle switch to enable or disable fast-switching. Refer to [Fast Switching \(page 32\)](#) for more information.

Input

Click this drop-down list to select the primary audio IP input. Select the **Not Used** option to leave the audio input unassigned.

Active Input

Displays the active audio IP Input.

Downmixing

Click this drop-down list to select how LPCM audio will be down-mixed. Note that lossless audio formats cannot be down-mixed.

Type	Description
None	Audio is not down-mixed.
Stereo	Audio is down-mixed to two-channel stereo.
Auto	Audio is down-mixed per the EDID of the connected HDMI device.

Status

Displays the audio input status. If no input is active or detected, then this field will display “No active audio”.

Mute

Click this toggle switch to enable or disable the audio output. If enabled, the toggle switch will be green.

Volume

Click the speaker icon on the left to decrease volume. Click the speaker icon on the right to increase volume. Range: 0 to 15.

Advanced Settings

Click the **SHOW ADVANCED** button to view the following options.

Slate Mode

Click this drop-down list to select the slate mode. Refer to [Slate / Logo Insertion \(page 27\)](#) for more information.

Mode	Description
Off	Disables the image from being displayed.
Manual	Stretches the image to fill the screen. In some cases this can distort (“stretch”) the image.
Auto	The image will only be displayed when the source signal is lost. For example, this mode is useful in conference room applications for displaying system instructions when no sources are connected.

Enable

Click this toggle switch to enable or disable the video wall feature. When enabled, the toggle switch will be green. Refer to [Creating Video Walls \(page 39\)](#) for more information.

TO PRIMARY

Click this button to assign as the Primary IP Input. Both Video and Audio support this feature.

TO BACKUP

Click this button to force the audio stream to fall over to the Backup IP Input (if redundancy is configured). Both Video and Audio support this feature.

Enable AES67

Click this toggle switch to enable or disable AES67. When enabled, the toggle switch will be green. Refer to [AES67 Audio \(page 34\)](#) for more information.

Auto On

Click this toggle switch to enable or disable power-on. When enabled this toggle switch will be green and the power-on command will be sent to the display when an A/V signal is detected.

Projector Cooldown (s)

Enter the time interval, in seconds, before the projector can be powered-off. This time interval prevents the decoder from sending additional commands until the projector has had time to complete its cool-down process.

Standby Timeout

Enter the time interval, in seconds, before the next command can be accepted by the display.

Type

Click this drop-down list to select the display mode.

Auto On

Click this toggle switch to enable or disable power-on. When enabled this toggle switch will be green and the power-on command will be sent to the display when an A/V signal is detected.

Serial page

The **Serial** page provides serial port configuration when using control signals.

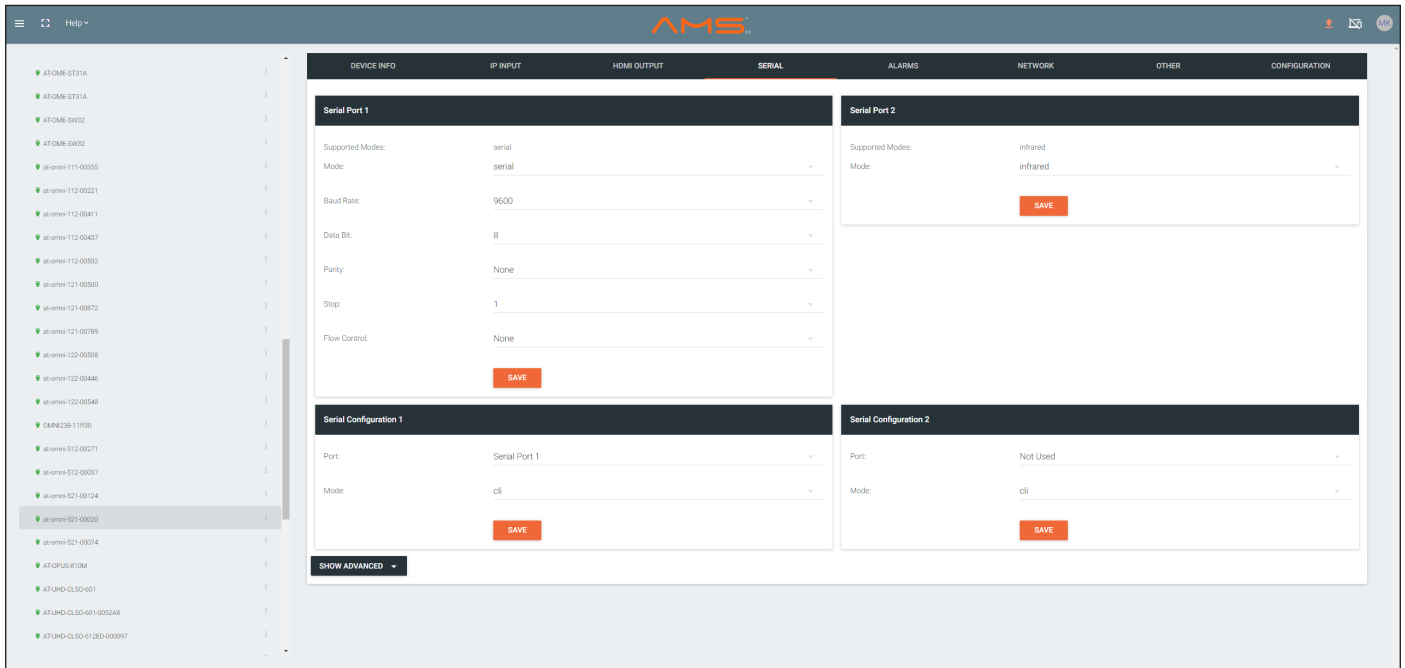

Supported Modes

Lists the supported protocols.

Mode

Click this drop-down list to select the desired serial mode: Infrared or Serial.

Baud Rate

Click this drop-down list to select the desired baud rate.

Data

Click this drop-down list to select the number of data bits.

Parity

Click this drop-down list to select the parity bit.

Stop

Click this drop-down list to select the stop bit.

Flow

Click this drop-down list to select the type of flow control.

Port

Click this drop-down list to select the port: **serial_port1**, **serial_port2**, or **Not Used**.

Mode

Click this drop-down list to select the desired control mode.

Interface	Description
cli	Displays the command-line interface of the decoder.
output	Serial port will send commands directly to the display device.
tcpproxy	Commands are sent over IP but triggered over the serial port.

Advanced Settings

Click the **SHOW ADVANCED** button to view the following options.

Command

Each of these The **Command** blocks are used to enter the command string for the desired operation: Display Off, Display On, Volume Down, and Volume Up.

Mode

Click this drop-down list to select where the command will be interpreted.

Interpret on	Description
Raw	Commands are interpreted at the encoder.
Decoder	Commands are interpreted at the decoder.

ASCII

Enter the ASCII representation of the command string in this field.

HEX

Enter the hexadecimal representation of the command in this field.



NOTE: When entering the command string, it is not required to enter the string under both the ASCII and HEX fields. The decoder requires that only one field be completed.

Network page

The **Network** page provides the ability to enable or disable DHCP mode for the physical interface. When DHCP mode is disabled, the IP address, subnet mask, and gateway must be provided. This screen is identical to the **Network** page for the encoder.

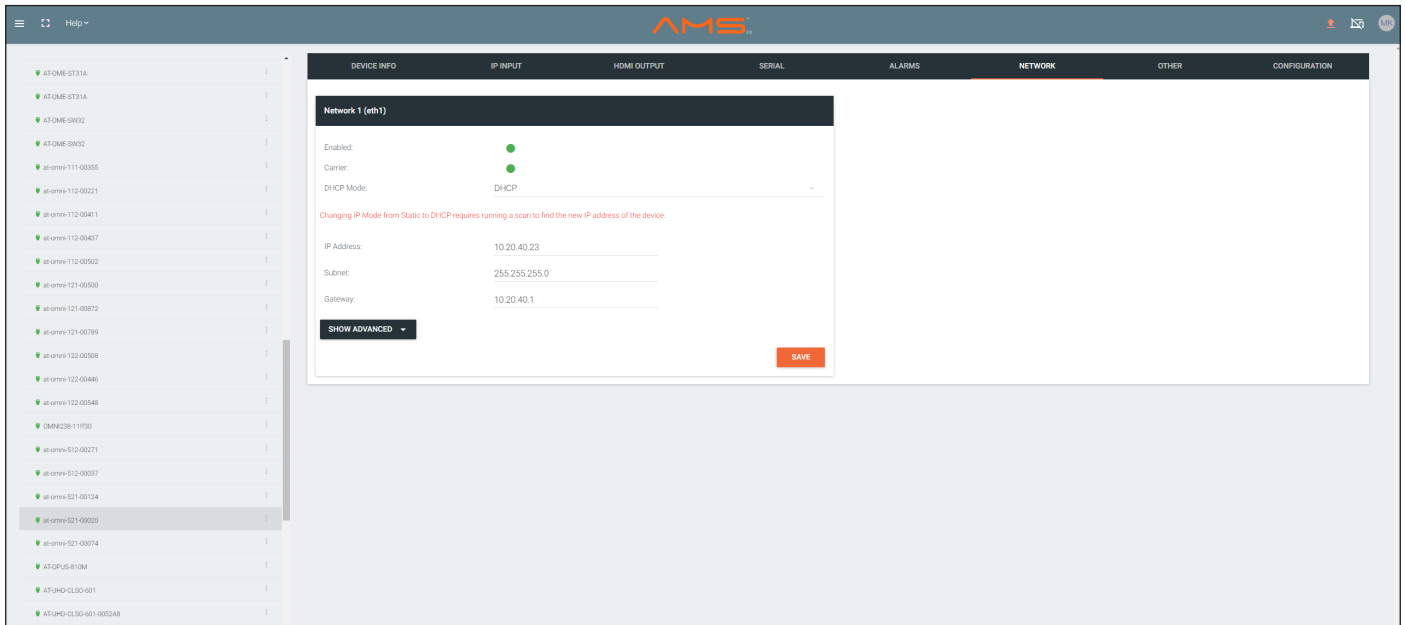

Enabled

This indicator displays whether or not the video stream for this channel is active. If the indicator is green, then the video stream is active.

Carrier

If this indicator is green, then an active link exists. Otherwise, if no link exists, this indicator will be red.

DHCP Mode

Click this drop-down list to select the desired network mode. Select DHCP to let the DHCP server (if present) assign the encoder the IP settings; **Subnet** and **Gateway** fields will automatically be populated. When **Static** mode is selected, the information for the **IP Address**, **Subnet**, and **Gateway** fields must be entered.

IP Address

Displays the IP address used by the channel. This field can only be changed if **Static** mode is selected.

Subnet

Displays the subnet mask for the channel. This field can only be changed if **Static** mode is selected.

Gateway

Displays the gateway (router) address for the channel. This field can only be changed if **Static** mode is selected.

Advanced Settings

Click the **SHOW ADVANCED** button to view the following options.

Link Speed

Displays the port speed in Mbps.

MAC Address

The MAC address of the Ethernet channel.

Telnet Authentication

Click this toggle switch to enable or disable Telnet authentication. If enabled, then the toggle switch will be green. Once enabled, connecting to the encoder using Telnet will require login credentials. The default credentials are:

Username: admin
Password: Atlona

Other page

The **Other** page provides logo/slate, text, and PTP management. Click the menu in the upper-left corner of the AMS screen to switch between **Logo**, **Text**, **PTP**, and **SAP** screens.

Logo

The **Logo** page provides the ability to upload a custom logo. This logo will be displayed when no video signal is detected. Separate logos can be uploaded: one for each channel. Refer to [Slate / Logo Insertion \(page 27\)](#) for more information on these settings.

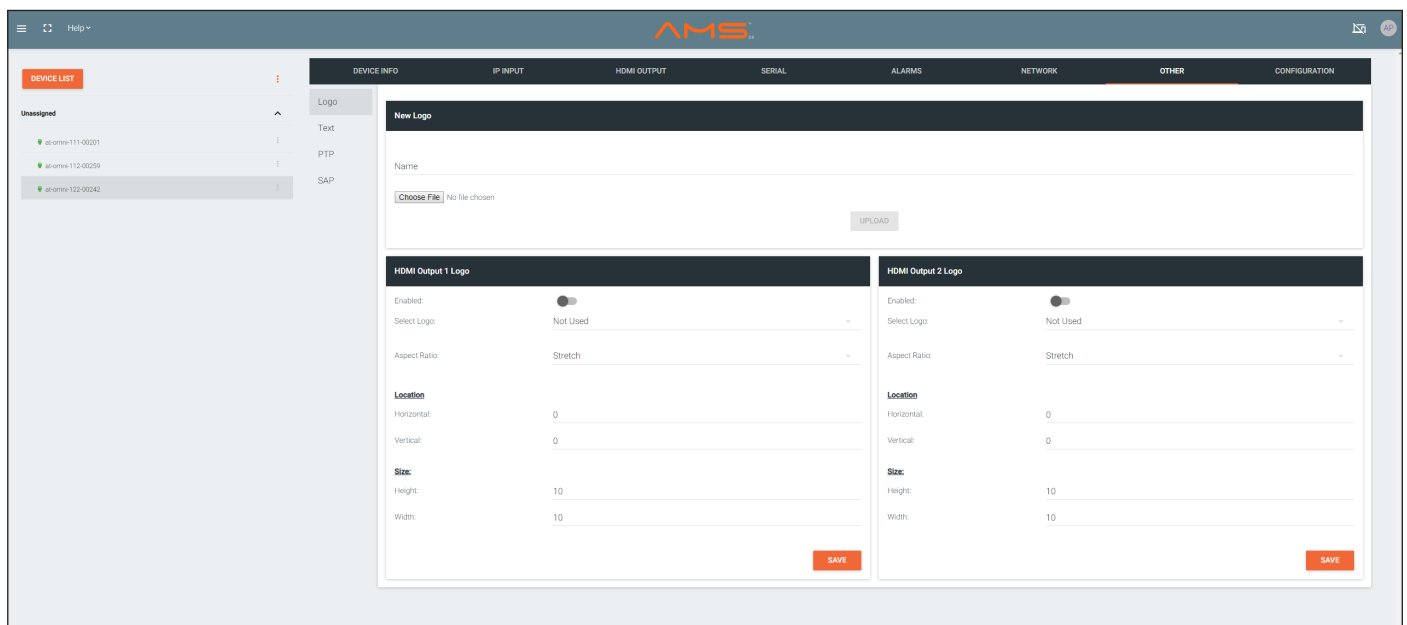

Name

Enter a name for the logo in this field.

Choose File

Click this button to select the logo file to be uploaded. Files must be in .png format and must not exceed 5 MB (5120000 bytes) in size. When an image file is uploaded, it will appear in the **Logo** drop-down list.

UPLOAD

Click this button to upload the logo file to the encoder.

Enabled

Click the toggle switch to enable or disable the logo. If the toggle switch is green, then the logo will be enabled.

Target

The name used by AMS to identify the encoder.

Select Logo

Click this drop-down list to select the desired logo. To disable the use of a logo, set to **Not Used**.

Aspect Ratio

Click this drop-down list to select the type of aspect ratio to be applied to the logo.

Horizontal

Enter the horizontal position of the logo on the screen.

Vertical

Enter the vertical position of the logo on the screen.

Height

Enter the horizontal resolution of the logo, in pixels.

Width

Enter the vertical resolution of the logo, in pixels.



IMPORTANT: Maximum logo resolution (both height and width) is 1/4 of the video resolution.

Text

The **Text** page provides the ability to display scrolling or stationary text superimposed on the source image. Refer to #text for more information.

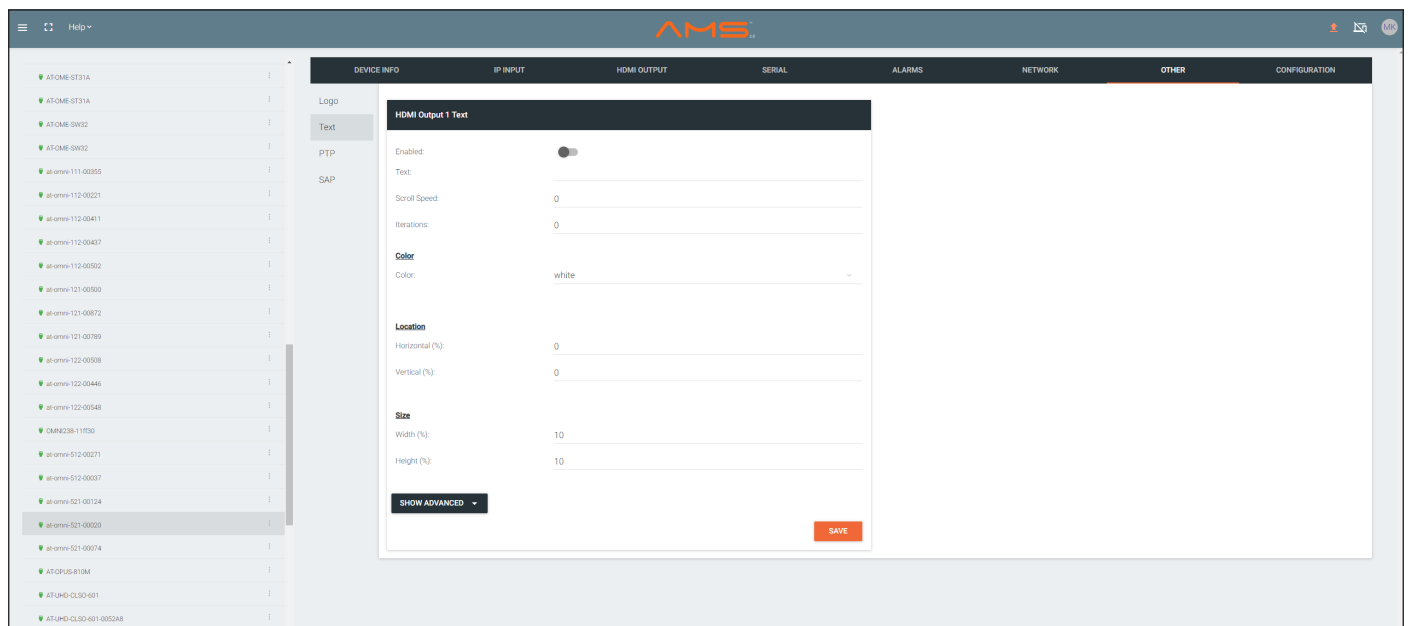

Enabled

Click this toggle switch to enable or disable the text. When the toggle switch is green, the text will be enabled.

Text

Enter the desired text in this field.

Scroll Speed

Enter the scrolling speed in this field. Values from -255 to 255 are valid. Negative numbers will scroll the text from left to right. Positive numbers will scroll text from right to left.

Iterations

Enter the number of iterations in the **Iteration** field. Set this field to 0 (zero) to set the number of iterations to infinity.

Color

Click this drop-down list to select a solid color preset: **red, green, black, white, yellow, or blue.**

Horizontal (%), Vertical (%)

Specify the location of the text in the Horizontal (%) and Vertical (%) fields. Each of these values is based on the horizontal and vertical resolution of the screen.

Width (%), Height (%)

Specify the size of the text in the Width (%) and Height (%) fields. Each of these values is based on the horizontal and vertical resolution of the screen.

Advanced Settings

Click the **SHOW ADVANCED** button to view the following options.

Red, Green, Blue, Alpha

Enter the RGBA values for each of the respective fields, to specify a custom color and transparency of the text. Enter the desired value in the Alpha field to control the transparency of the text. A value of 255 is opaque and a value of 0 is transparent. Numbers from 0 to 255 are valid for each of these fields.

PTP

The **PTP** page provides options for adjust Precision Time Protocol (PTP) for AES67 audio streams. PTP is used by AES67 to keep all audio streams synchronized.

For a system utilizing PTP, all devices undergo an automatic self-election process to choose the interface to be used as the PTP grandmaster (GM) clock, based on the accuracy of the device's clock and the device's configured priority. A lower priority number means the unit is more likely to get selected as GM.



IMPORTANT: If a new device is added to the network and the GM changes, a brief outage will be experienced while all connected devices synchronize with the new clock. Because of this, Atlona recommends that one unit gets manually defined as the GM and have both **Priority 1** and **Priority 2** fields be set to 1.

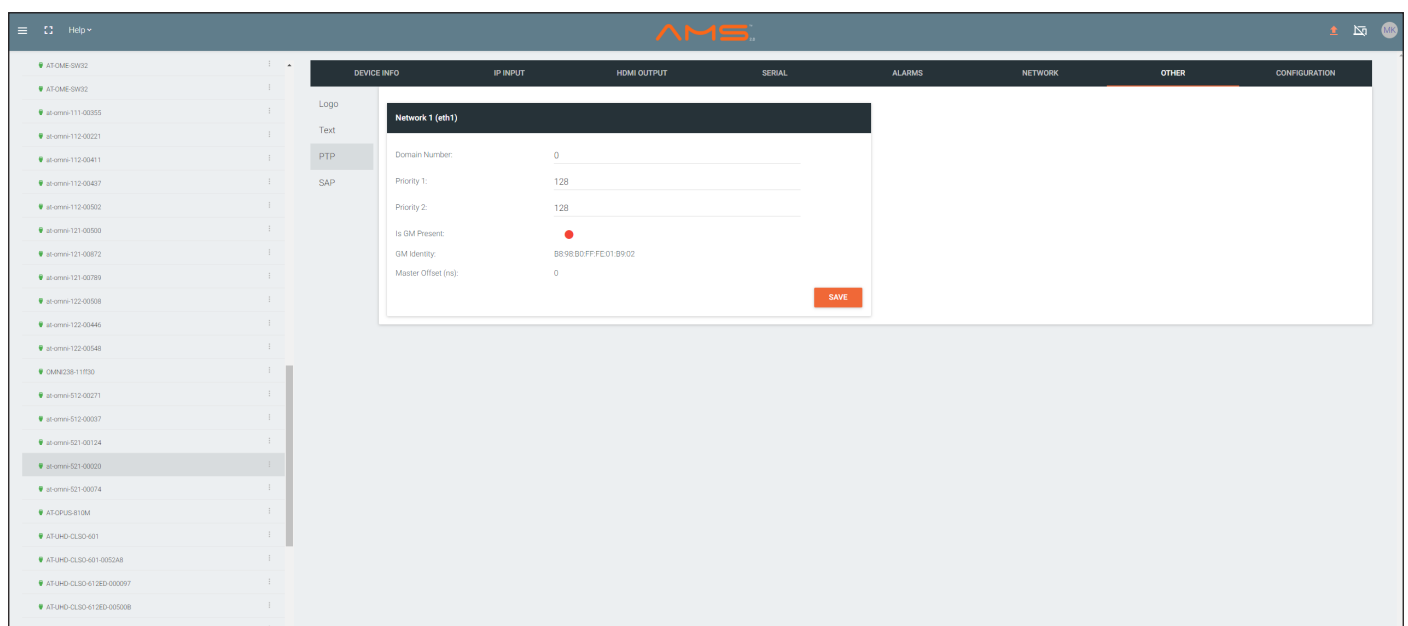

Domain Number

Enter the domain number in this field. Valid entries are 0 through 127.

Priority 1

Enter the priority number in this field.

Priority 2

Enter the priority number in this field.

Is GM Present

This indicator displays the existence of a grandmaster clock for the specified PTP domain number. If the indicator is green, then the grandmaster clock exists on this interface.

GM Identity

The grandmaster clock identity. If this field is blank, then it means that this interface is the grandmaster clock.

Master Offset

Displays the grandmaster clock offset.

SAP

The **SAP** page enables or disables the Session Announcement Protocol protocol. Enabling SAP configures the decoder to look for SAP messages from decoders on the network that are configured to send SAP. Any messages that are discovered will be displayed here.

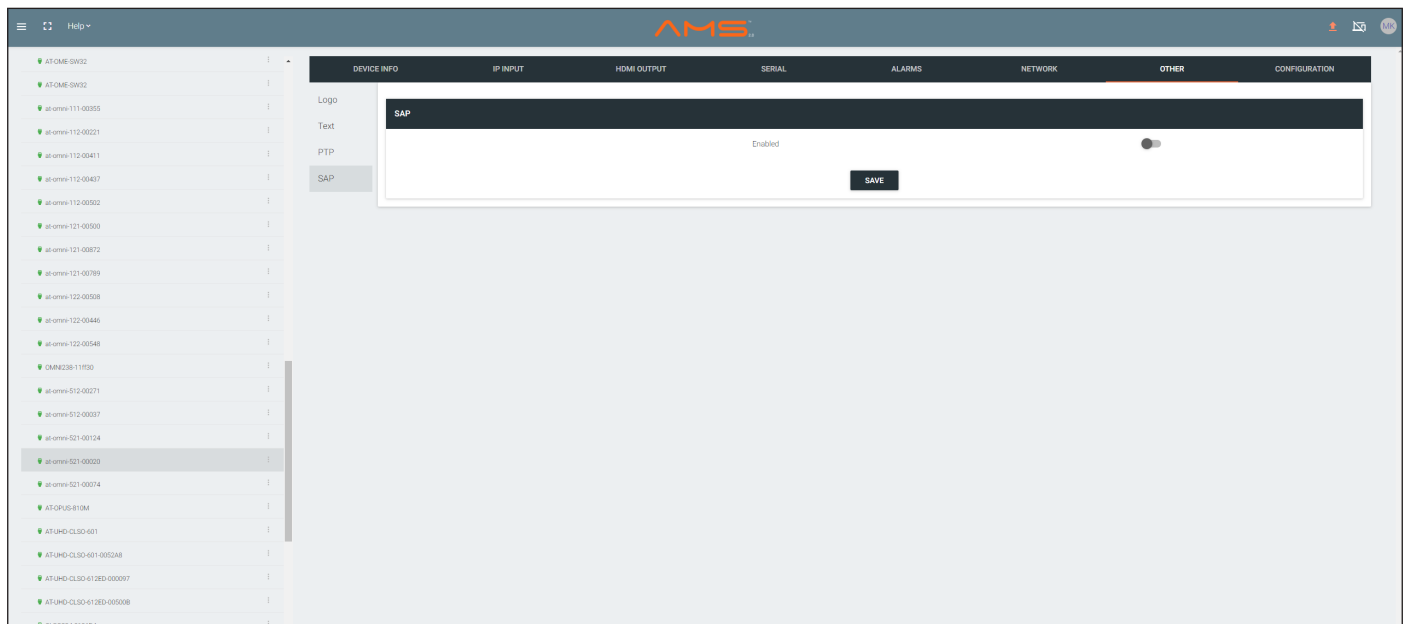

Enable

Click this toggle switch to enable or disable SAP. If enabled, the toggle switch will be green. Click the **SAVE** button to commit changes.

The Virtual Matrix

1. In AMS, click **Devices** from the fly-out menu.
2. Click the **OmniStream** option.
3. Click **Virtual Matrix**.

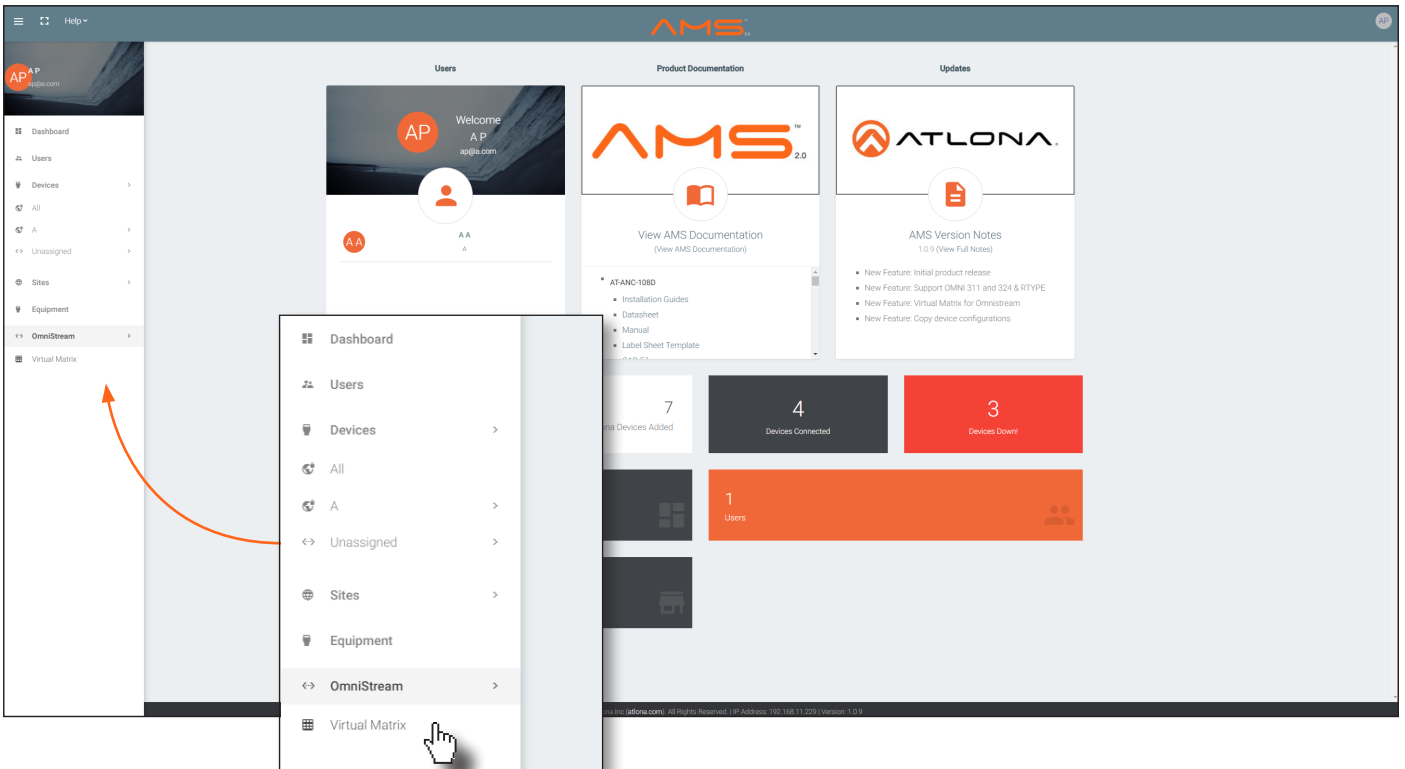

4. The **OmniStream Virtual Matrix** page will be displayed.

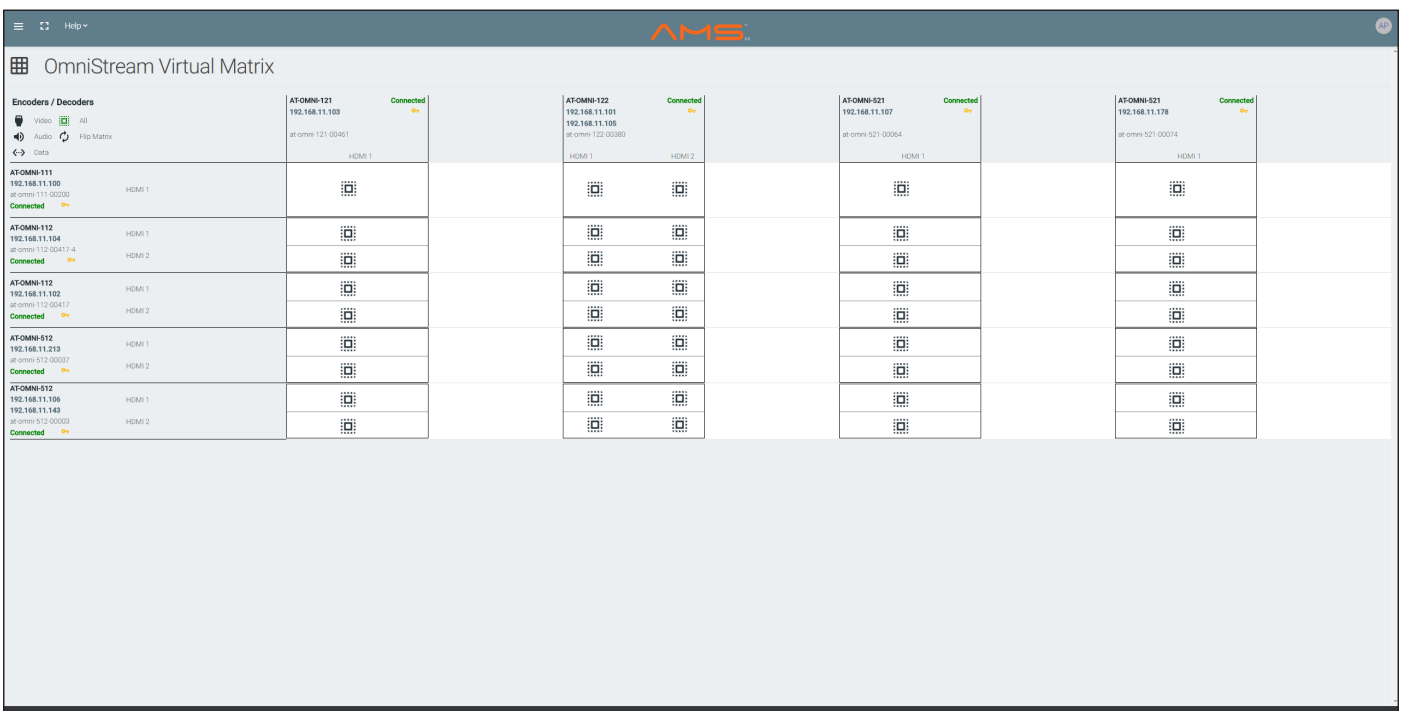

Layout and Operation

The illustration below, shows a multiple OmniStream units (encoders and decoders). The Virtual Matrix is organized into rows and columns.

The blue circle with the checkmark indicates that these two OmniStream units are connected to one another. The third column shows an OmniStream R-Type decoder (AT-OMNI-521). The fourth row shows an OmniStream R-Type encoder (AT-OMNI-512). In this example, the source signal on **HDMI 1 IN** (encoder) is being sent out, over the network, and will be displayed on **HDMI 1** on the decoder. This will create a *cross-connection*, which connects both the encoder and decoder together.

- **Creating a cross-connection**

To route an input on an encoder to an output, locate the row and column where an input and output intersect, then click the square with the dots around it.

- **Removing a cross-connection**





To remove a *cross-connection*, click on the desired circle icon with the check mark symbol. The square with the dots around it will be displayed indicating that the *cross-connection* has been removed.

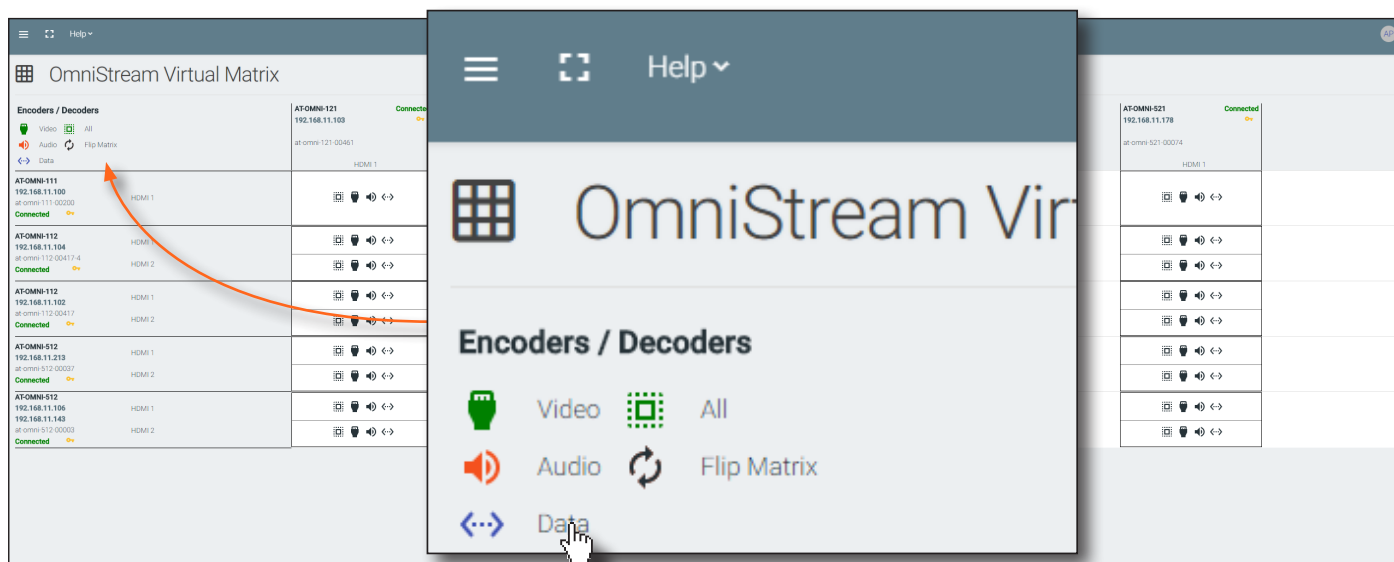

- To view the individual streams for video, audio, and data, click the icons on the upper-left corner of the screen.



When these icons are clicked, the associated icons will be displayed in the rows and columns of the Virtual Matrix.

Symbol	Description
	Video only
	Audio only
	Data only
	Connected; not all signals are active
	Connected; all streams are being used

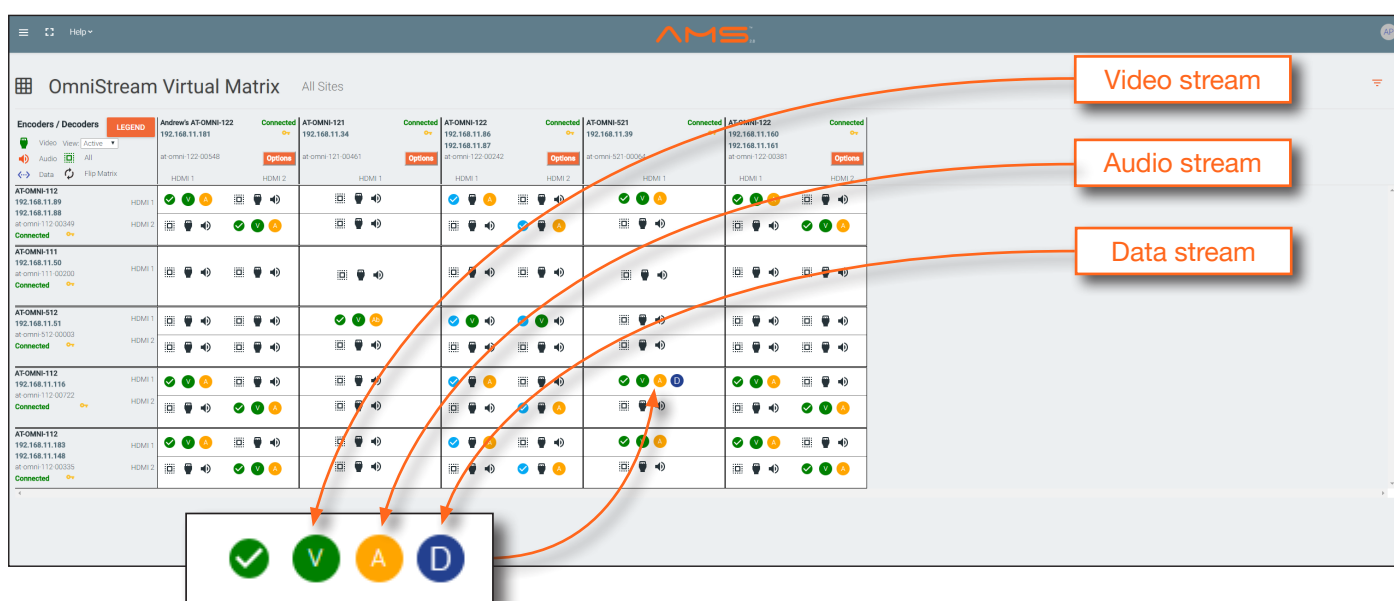

IMPORTANT: R-Type and Pro compatibility: R-Type encoders (AT-OMNI-512) and decoders (AT-OMNI-521) operate in Video Mode, only. Pro encoders can be set to either Video Mode or PC Mode. Video Mode is incompatible with PC Mode. Therefore, in order for both R-Type and Pro encoders/decoders to work within a system, Pro encoders/decoders must be set to Video Mode.

- Click the **Video**, **Audio**, and **Data** icons to return to the normal view.
- Since only HDMI (both audio and video) is being used, the V (video) and A (audio) icons are displayed. The blue circle with the checkmark indicates that the cross-section has been created. However, not all streams are being used. Refer to the chart below.
- This illustration also shows that the data stream (the icon with two arrows and three dots), which is used for control, is also being used and is displayed as a dark-blue circle with the letter “D”.
- The icons in the upper-left corner can also act as a filter. This allows for a clear breakdown of where signals are being routed and is useful when several encoders and decoders are used on a network.

Web Server

Accessing the Web Server

In order to access the web server of the desired encoder/decoder, the IP address of the encoder must be known. This can be accomplished by more than one method. Running IP scanner software or using the Address Resolution Protocol (ARP) are two possibilities. When running an IP scanner or using ARP, both the computer and the OmniStream encoders/decoders must be connected to the same network.



TIP: Atlona recommends downloading and using the Network Assignment Planner, when setting up OmniStream products on the network. Recording this information in this document will provide a “snapshot” of the current OmniStream network configuration. The Network Assignment Planner is available for download on the OmniStream product pages, under the Resources tab.

Getting the IP Address

The following method uses the `arp` command, which is available from the command line in Windows. The `arp` command will display the IP-to-physical address translation tables used by the Address Resolution Protocol (ARP). The following procedure can be used for both encoders and decoders.

1. Identify the desired encoder/decoder by locating the MAC address on the bottom of the unit. *Figure 1.1* shows a sample label from an AT-OMNI-112 dual-channel encoder.

The MAC address for the Ethernet 1 physical interface is B8:98:B0:01:F7:EB.

Figure 1.1 - Sample label on the bottom of a dual-channel encoder.

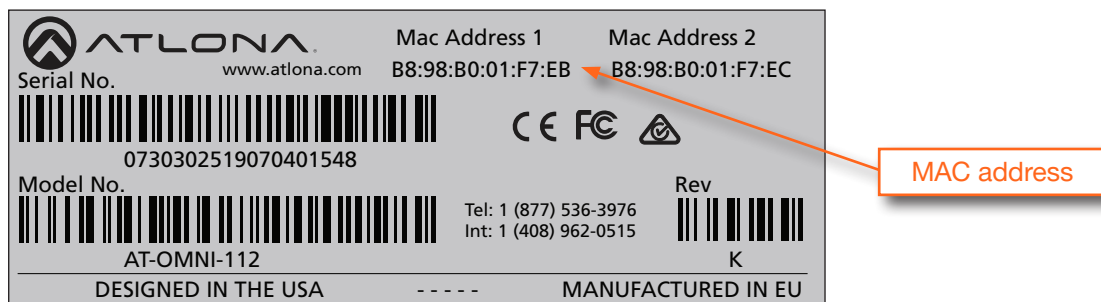

2. Connect a PC to the same network where the OmniStream encoders/decoders are connected.
3. Type `cmd` in the search bar, then press [ENTER] to launch the command line interface.

- At the command prompt, type `arp -a`. Make sure to include a space between `arp` and the `-a` argument, then press [ENTER].
- Press [ENTER]. Several lines of information will be displayed. Locate the MAC address of the encoder/decoder, under the **Physical Address** column. Directly across from the MAC address, the IP address of the encoder/decoder will be listed under the **Internet Address** column.

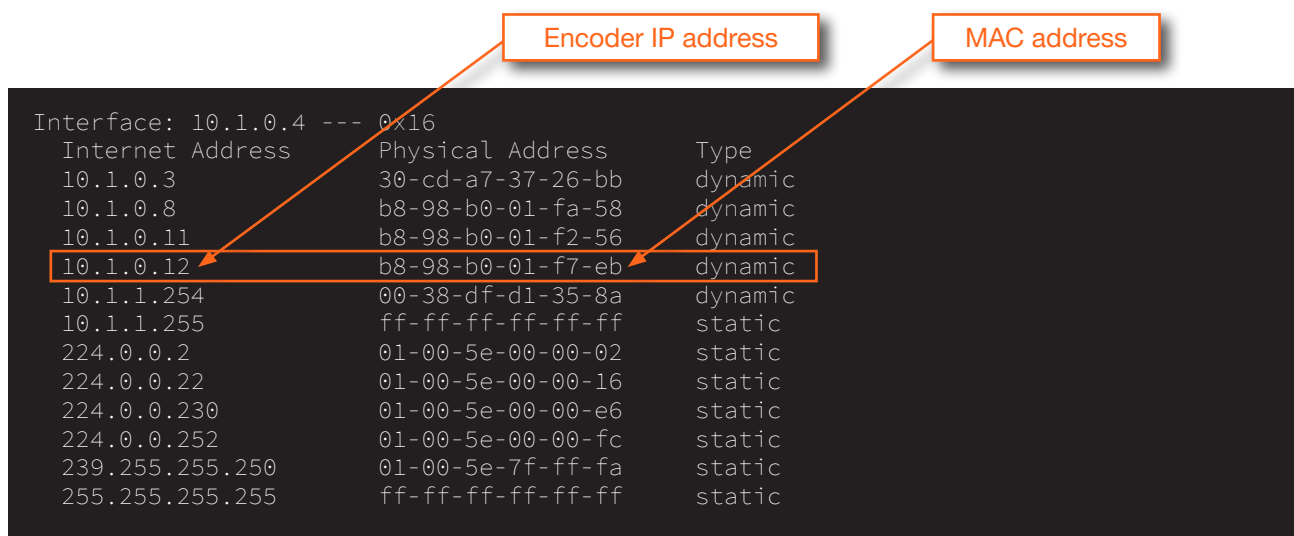

```

Interface: 10.1.0.4 --- 0x16
Internet Address      Physical Address      Type
10.1.0.3             30-cd-a7-37-26-bb    dynamic
10.1.0.8             b8-98-b0-01-fa-58    dynamic
10.1.0.11            b8-98-b0-01-f2-56    dynamic
10.1.0.12            b8-98-b0-01-f7-eb    dynamic
10.1.1.254           00-38-df-d1-35-8a    dynamic
10.1.1.255           ff-ff-ff-ff-ff-ff    static
224.0.0.2            01-00-5e-00-00-02    static
224.0.0.22           01-00-5e-00-00-16    static
224.0.0.230          01-00-5e-00-00-e6    static
224.0.0.252          01-00-5e-00-00-fc    static
239.255.255.250      01-00-5e-7f-ff-fa    static
255.255.255.255      ff-ff-ff-ff-ff-ff    static
  
```

Logging In

- Launch the desired web browser and enter the IP address of the encoder in the address bar.
- Enter the username and password. Note that the password field will always be masked. The default credentials are:

Username: admin
 Password: Atlona

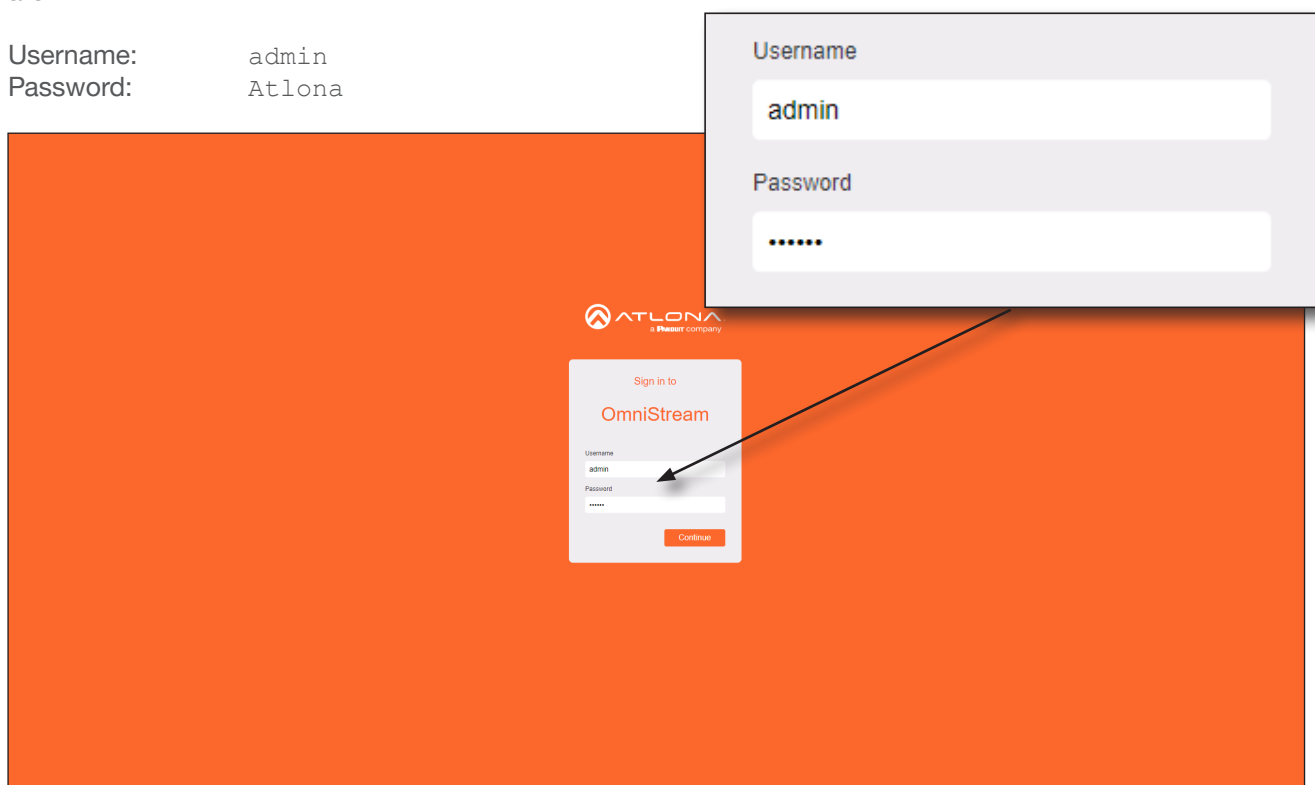

3. The **System Information** page will be displayed.

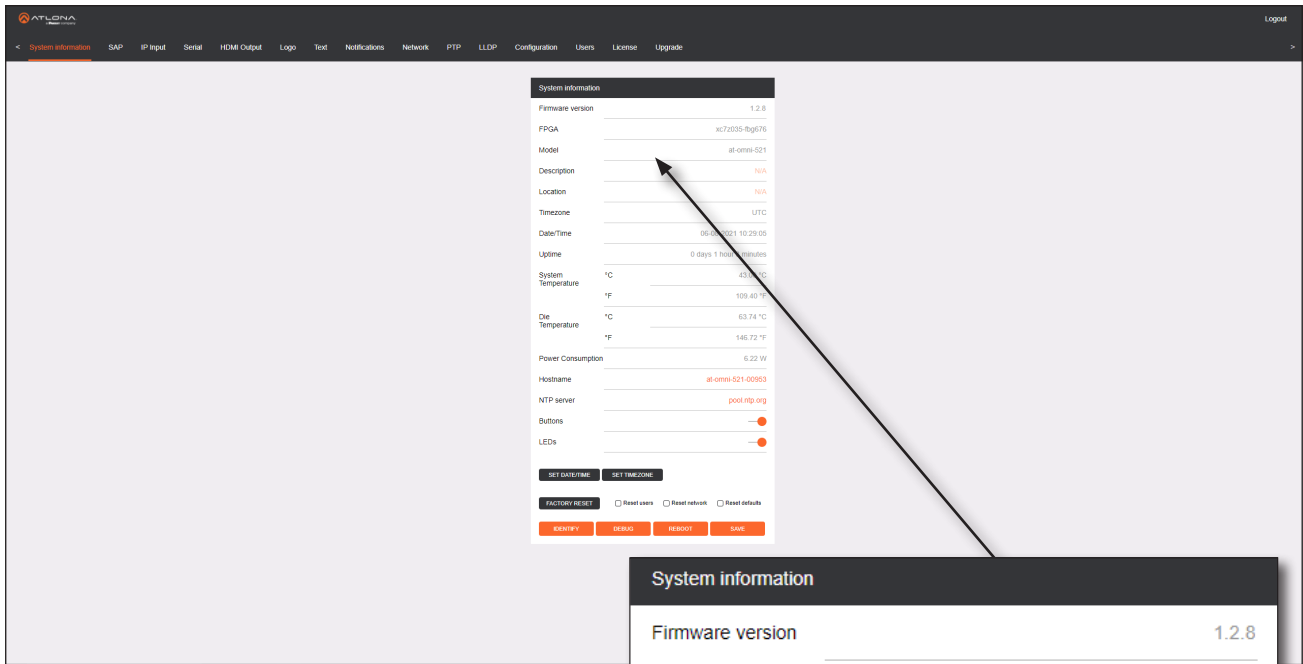

4. The login process is complete.

System information

Firmware version	1.2.8
FPGA	xc7z035-fbg676
Model	at-omni-521
Description	N/A
Location	N/A
Timezone	UTC
Date/Time	06-08-2021 10:29:05
Uptime	0 days 1 hour 3 minutes
System Temperature	°C 43.00 °C °F 109.40 °F
Die Temperature	°C 63.74 °C °F 146.72 °F
Power Consumption	6.22 W
Hostname	at-omni-521-00953
NTP server	pool.ntp.org
Buttons	<input checked="" type="checkbox"/>
LEDs	<input checked="" type="checkbox"/>

SET DATE/TIME
SET TIMEZONE

FACTORY RESET
 Reset users
 Reset network
 Reset defaults

System information page

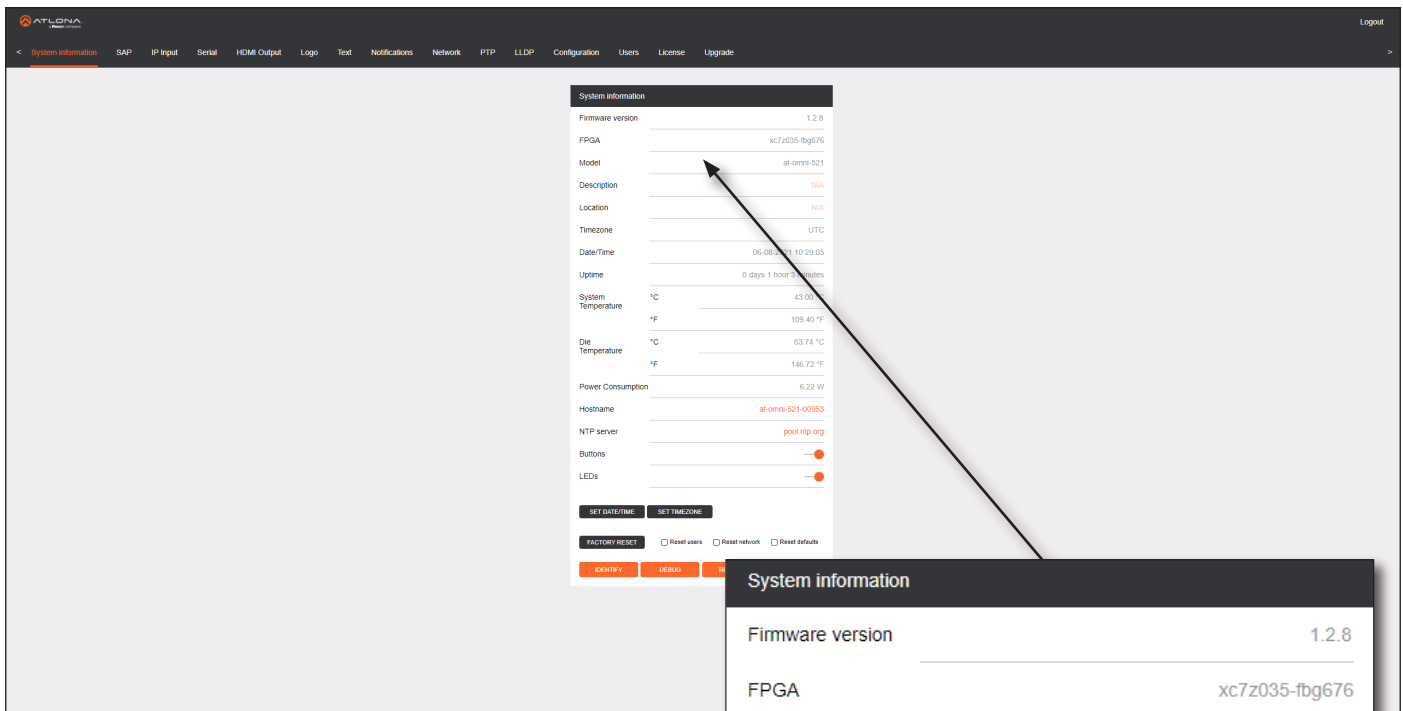

Firmware version

The version of firmware that the encoder is running. Always make sure the latest version of firmware is installed.

FPGA

Displays the FPGA model number and the size.

Model

The model number of the unit.

Description

Provides the option of assigning descriptive name to the unit.

Location

Provides the option of assigning a description of where the unit is located.

Timezone

Displays the time zone format. Click the **SET TIMEZONE** button, to assign the time zone.

Date/Time

Displays the current date and time. Click the **SET DATE/TIME** button to set these values.

Uptime

Displays the elapsed time since the unit was powered-on or rebooted.

System information

Firmware version	1.2.8
FPGA	xc7z035-fbg676
Model	at-omni-521
Description	N/A
Location	N/A
Timezone	UTC
Date/Time	06-08-2021 10:29:05
Uptime	0 days 1 hour 3 minutes
System Temperature	°C 43.00 °C
	°F 109.40 °F
Die Temperature	°C 63.74 °C
	°F 146.72 °F
Power Consumption	6.22 W
Hostname	at-omni-521-00953
NTP server	pool.ntp.org
Buttons	●
LEDs	●

SET DATE/TIME
SET TIMEZONE

FACTORY RESET
 Reset users
 Reset network
 Reset defaults

System Temperature

Displays the ambient enclosure temperature.

Die Temperature

Displays the value returned from the die temperature sensor (DTS) on the chip of the PCB.

Power Consumption

Displays the precise power consumption of the encoder.

Hostname

Displays the hostname of the encoder. By default, OmniStream decoders are assigned a default hostname, which is constructed as follows: at-omni-[SKU]-[last five digits of MAC address]. If using a custom hostname, it must meet the hostname standards, defined here: <https://tools.ietf.org/html/rfc1123>.

NTP Server

Displays the NTP server (if used). Click this field to enter the desired NTP server address.

Buttons

Click this toggle switch to enable or disable the button backlight indicators on the front-panel.

LEDs

Click this toggle switch to enable or disable all front-panel LED indicators and button backlight indicators.

SET DATE/TIME

Click this button to set the current date and time.

SET TIMEZONE

Click this button to set the desired time zone.

FACTORY RESET

Click this button to reset the encoder to factory-default settings. When performing a factory reset, the following options can be selected, by clicking the check box. If no options are selected, then the encoder is reset with no factory-default settings.

Option	Description
None Checked	Resets the encoder with no factory-default settings.
Reset User	Resets the encoder to factory-default settings and resets custom user information.
Reset Network	Resets the encoder to factory-default settings and resets network information.
Reset Defaults	Resets the encoder to factory-default settings. In addition, static multicast addresses are configured. This option can be used to configure a single encoder to transmit to any number of decoders without using the Virtual Matrix within AMS.
	 IMPORTANT: This option will not work for multiple decoders on the same network.

IDENTIFY

Click this button to physically identify a unit on the network. Clicking this button will cause all front-panel LED indicators to flash for 10 seconds.

DEBUG

Click this button to instruct the unit to create a debug file. This file is used by Atlona Technical Support Engineers to diagnose internal issues with the unit.

REBOOT

Click this button to perform a soft reboot of the encoder.

SAVE

Click this button to commit changes to the settings on this page.

SAP page

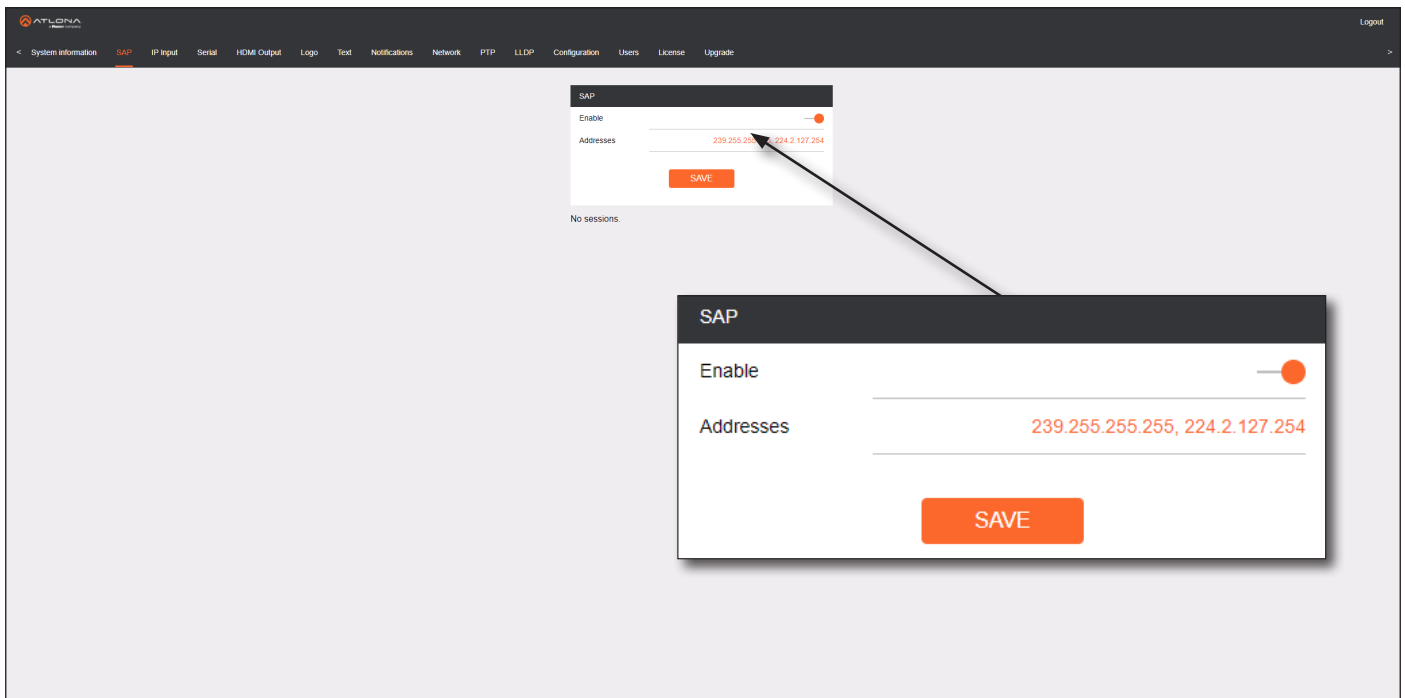

Enable

Click this toggle to enable or disable SAP. This feature is enabled when the toggle switch is orange. This is the default setting.

Addresses

Encoders currently send SAP announcements on two multicast addresses: 224.2.127.254 and 239.255.255.255. In some rare instances, this can conflict with other network address settings. Custom SAP addresses can be specified in this field.



NOTE: If the **Addresses** field is changed, then the same changes must be applied to all devices, in order for all devices to see the SAP multicast.

IP Input page

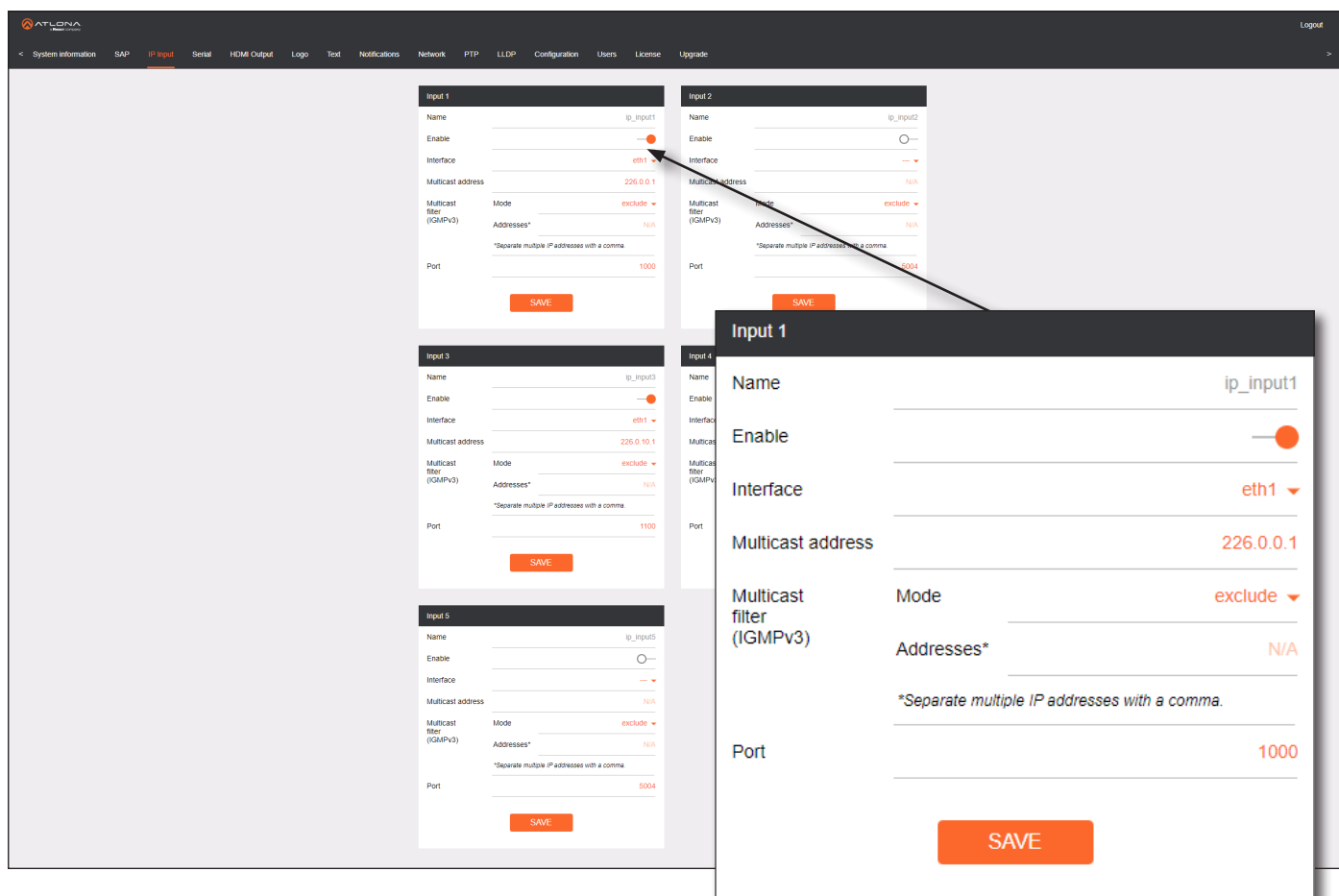

Input window groups

The following fields apply to all **Input** window groups.

Name

The name of the input. This field cannot be changed.

Enable

Click this toggle switch to enable or disable the IP input.

Interface

Click this drop-down list to select the desired Ethernet interface.

Multicast address

Enter the multicast IP address of the subscribed encoder in this field.

Multicast filter (IGMPv3) > Mode

Click this drop-down list to select the multicast filtering mode. Available options are **exclude** or **include**.

Multicast filter (IGMPv3) > Addresses

Enter the desired address(es) in this field. Separate multiple multicast IP addresses with a comma delimiter.

Port

Enter the port number of the subscribed encoder in this field.

SAVE

Click this button to commit all changes in the **Input** window group.

Serial page

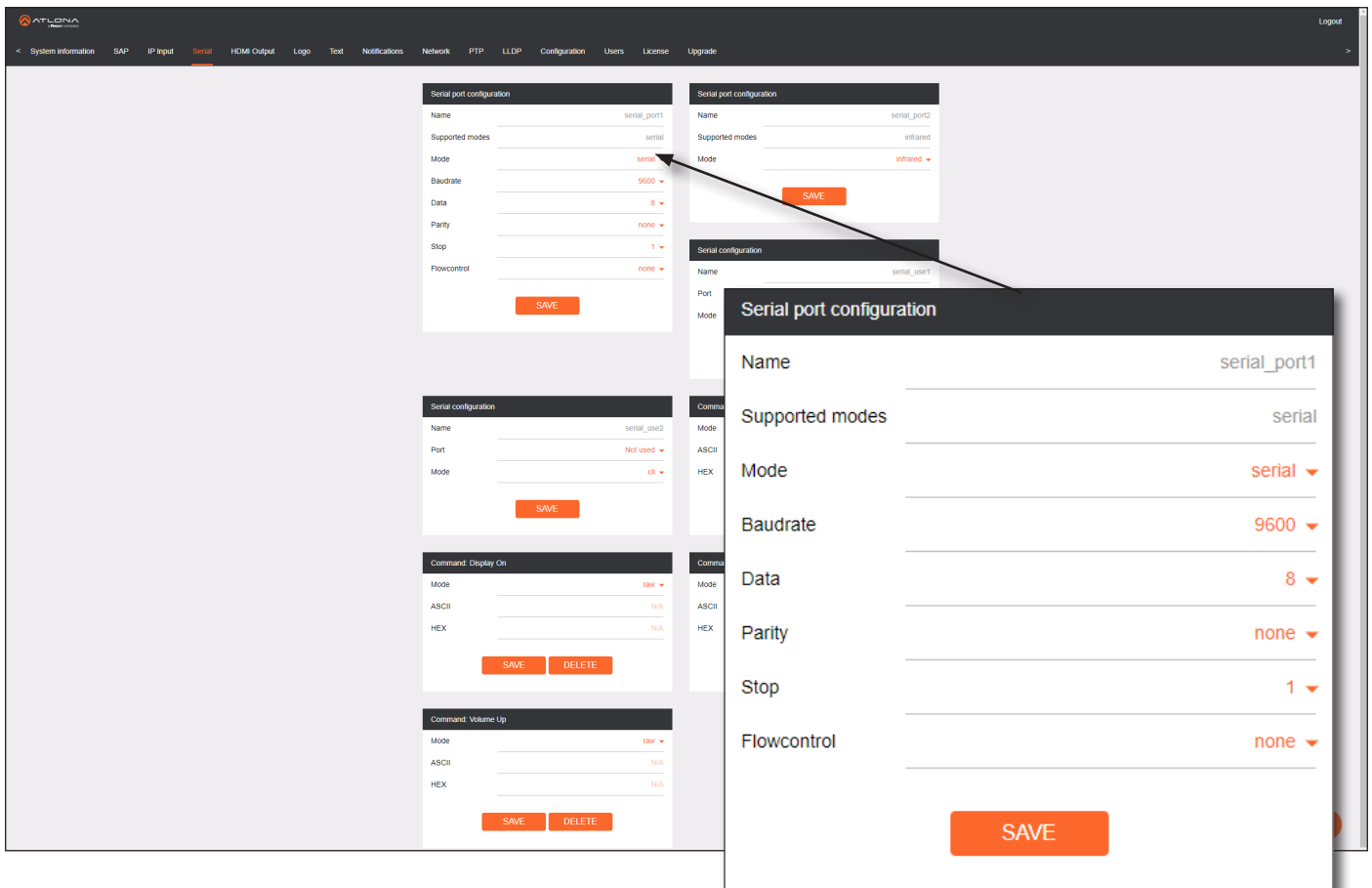

Serial port configuration window groups

The following fields apply to both **Serial port configuration** window groups.

Name

The name of the serial port. This field cannot be changed.

Supported Modes

Displays the supported protocols for the serial port. This field cannot be changed.

Mode

Click this drop-down list to select the desired serial mode. Available values will be reflected in the **Supported Modes** field. Note that serial port 1 only supports serial (RS-232) control and serial port 2 only supports infrared (IR).

Baudrate

Click this drop-down list to select the desired baud rate: **115200**, **57600**, **38400**, **19200**, or **9600**. Only supported on serial port 1.

Data

Click this drop-down list to select the number of data bits: **6**, **7**, or **8**. Only supported on serial port 1.

Parity

Click this drop-down list to select the parity bit: **None**, **Odd**, **Even**, **Mark**, or **Space**. Only supported on serial port 1.

Stop

Click this drop-down list to select the stop bit: **1**, **1.5**, or **2**. Only supported on serial port 1.

Flow Control

Click this drop-down list to select the type of flow control: **none**, **xonxoff**, or **hw**.

Port

Click this drop-down list to select the desired serial port: **Serial Port 1** or **Serial Port 2**.

SAVE

Click this button to commit all changes within the **Serial port configuration** window group.

Serial configuration window groups

The following fields apply to both **Serial configuration** window groups.

Name

The name of the port. This field cannot be changed.

Port

Click this drop-down list to select the desired serial port.

Mode

Click this drop-down list to select the desired control mode. Available values are: **cli** and **tcpproxy**. Select **tcpproxy** to send IP commands directly to the decoder, which are then output over RS-232 to the display (sink) device. Selecting the **cli** option will pass through RS-232 data, directly from a control system, to the sink device that is connected to the decoder.

SAVE

Click this button to commit all changes within the **Serial configuration** window group.

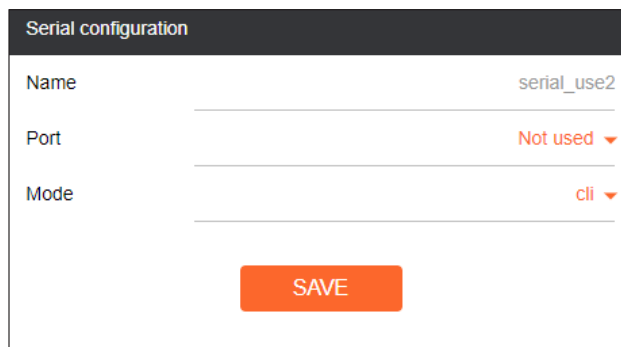

Serial configuration	
Name	serial_use2
Port	Not used ▼
Mode	cli ▼
<input type="button" value="SAVE"/>	

Command window groups

By default, window groups for the following commands are created: **Display Off**, **Display On**, **Volume Down**, and **Volume Up**.

Interpret on

Click this drop-down list to select the endpoint where the command will be processed: **encoder** or **decoder**.

ASCII

Enter the ASCII representation of the command string in this field.

HEX

Enter the hexadecimal representation of the command in this field.

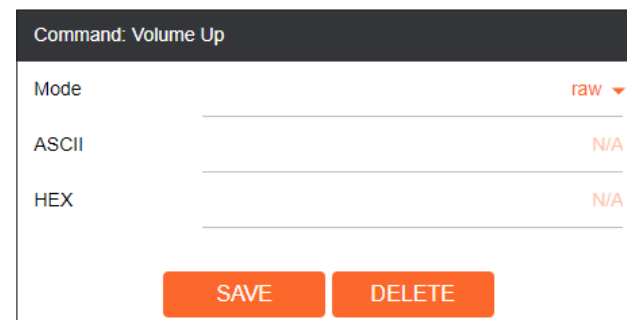

Command: Volume Up	
Mode	raw ▼
ASCII	N/A
HEX	N/A
<input type="button" value="SAVE"/> <input type="button" value="DELETE"/>	

SAVE

Click this button to commit all changes within the **Command** window group.

DELETE

Click this button to remove the information for this command.



NOTE: When entering the command string, it is not required to enter the string under both the ASCII and HEX fields. The encoder requires that one field be completed.



New Command

Click this button to create a new command window group. Provide a name for the command in the displayed dialog box, then click the **Create** button. Complete each of the fields, as described above.

HDMI Output page

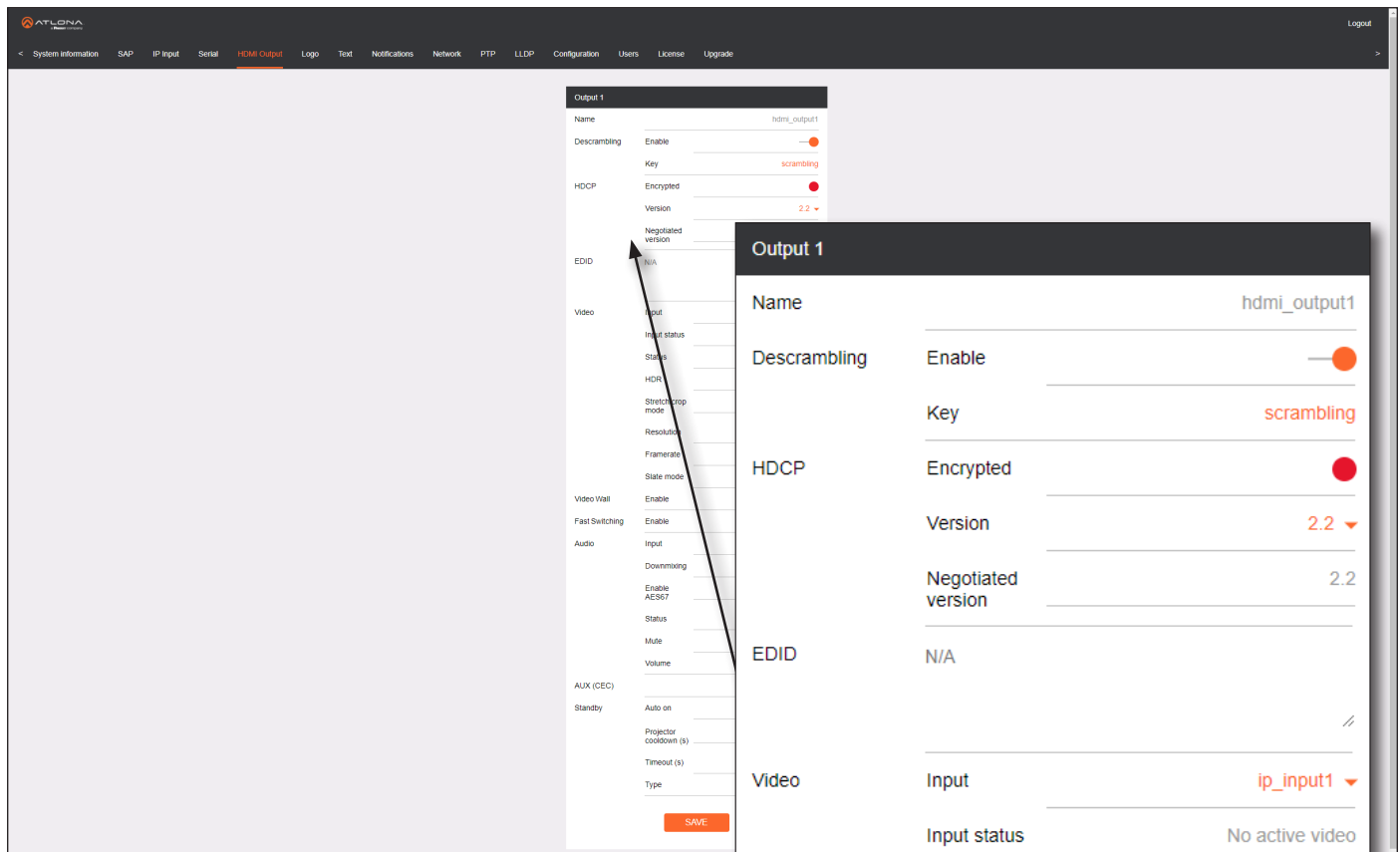

Output window group

Name

The name of the output port. This field cannot be changed.

Enable

Click this toggle switch to enable or disable scrambling. If a scrambling key is used on the subscribed encoder, then descrambling must be enabled on the decoder in order for the source signal to reach the sink device.

Key

Enter the descrambling key in this field. This key must match the scrambling key on the subscribed encoder.

Encrypted

This indicator will be green if the stream content is HDCP-encrypted.

Version

Click this drop-down list to select the supported version of HDCP.

Negotiated version

Displays the version of HDCP used by the stream.

EDID

This field will display the EDID of the connected display. This raw data can be copied and stored under the EDID page, if desired.

Input

Click this drop-down list to select the desired IP input. Available options are ip_input1 - ip_input5, none, and generator.

Input status

Displays the input status. If no video stream is detected, then “No active video” will be displayed.

Status

Displays the active video input. If no input is active or detected, then this field will display “No active video”.

HDR

This indicator will be green if HDR video is present.

Stretch / Crop Mode

Click this drop-down list to select the aspect ratio.

Video	Input	ip_input1 ▼
	Input status	No active video
	Status	No active video
	HDR	●
	Stretch/crop mode	keep aspect ratio ▼
	Resolution	auto ▼
	Framerate	auto ▼

Mode	Description
Keep Aspect Ratio	Aspect ratio is preserved; the output on the decoder will be the same as the input on the encoder.
Full Screen	Stretches the image to fill the screen. In some cases this can distort (“stretch”) the image.
16:9	Sets the aspect ratio to 16:9 “widescreen” format, usually associated with HDTV formats.
16:10	Sets the aspect ratio to 16:10 “widescreen” format, usually associated with computer displays and smart devices.
4:3	Sets the aspect ratio to 4:3 “pan-and-scan” format, usually associated with SDTV.

Resolution

Click this drop-down list to select the desired output resolution. This is a scaler feature which can either upscale or downscale the output on the decoder. If **Input** is selected, then no scaling will be applied to the output. Select **Auto** to use the EDID of the sink device to determine the output resolution.

Resolutions	
Input	1440 x 1050
Auto	1440 x 900
4096 x 2160	1280 x 1024
3840 x 2160	1280 x 800
1920 x 1200	1280 x 768
1920 x 1080	1280 x 720
1680 x 1050	1024 x 768
1600 x 900	

Framerate

Sets the output frame rate. Available options are auto, 60 Hz, 50 Hz, and 30 Hz.

Slate Mode

Click this drop-down list to select the slate mode. Refer to [Slate / Logo Insertion \(page 27\)](#) for more information.

Mode	Description
Off	Disables the image from being displayed.
Manual	Stretches the image to fill the screen. In some cases this can distort (“stretch”) the image.
Auto	The image will only be displayed when the source signal is lost. For example, this mode is useful in conference room applications for displaying system instructions when no sources are connected.

Video Wall

Click this toggle switch to enable or disable the video wall option. Refer to [Creating Video Walls \(page 39\)](#) for more information on using video walls.

Fast Switching

Click this toggle switch to enable or disable fast-switching. Refer to [Fast Switching \(page 32\)](#) for more information.

Input

Click this drop-down list to select the primary audio IP input. Select the **Not Used** option to leave the audio input unassigned.

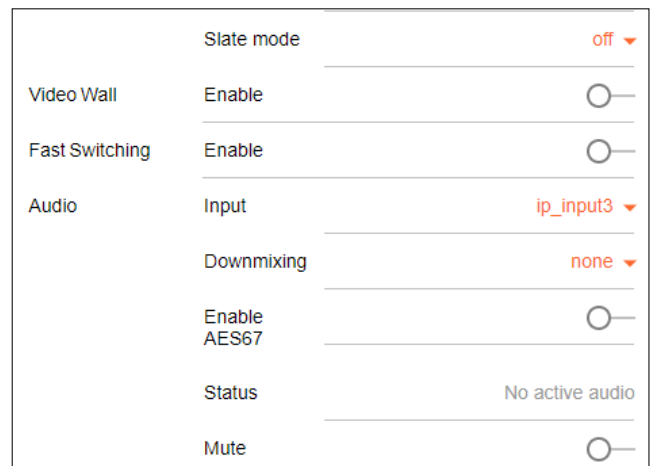

Screenshot of the web server interface showing the following settings:

- Slate mode: off
- Video Wall: Enable (toggle switch)
- Fast Switching: Enable (toggle switch)
- Audio Input: ip_input3
- Downmixing: none
- Enable AES67: (toggle switch)
- Status: No active audio
- Mute: (toggle switch)

Downmixing

Click this drop-down list to select how LPCM audio will be down-mixed. Note that lossless audio formats cannot be down-mixed.

Type	Description
None	Audio is not down-mixed.
Stereo	Audio is down-mixed to two-channel stereo.
Auto	Display is always on, source audio/video signal switches on/off

Enable AES67

Click this toggle switch to enable or disable AES67. When enabled, the toggle switch will be green. Refer to [AES67 Audio \(page 34\)](#) for more information.

Status

Displays the active audio input. If no input is active or detected, then this field will display “No active audio”.

Mute

Click this toggle switch to enable or disable the audio output. If enabled, the toggle switch will be green.

Volume

Click the speaker icon on the left to decrease volume. Click the speaker icon on the right to increase volume. Range: 0 to 15.

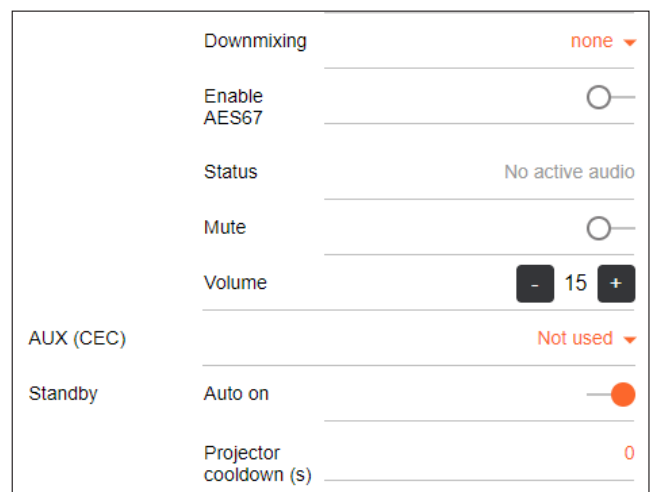

Screenshot of the web server interface showing the following settings:

- Downmixing: none
- Enable AES67: (toggle switch)
- Status: No active audio
- Mute: (toggle switch)
- Volume: 15 (with - and + buttons)
- AUX (CEC): Not used
- Standby: Auto on (toggle switch)
- Projector cooldown (s): 0

AUX (CEC)

Click this drop-down list to select the desired IP input for CEC control. Available options are ip_input1 - ip_input5.

Auto On

Click this toggle switch to enable or disable power-on. When enabled this toggle switch will be green and the power-on command will be sent to the display when an A/V signal is detected.

Projector Cooldown (s)

Enter the time interval, in seconds, before the projector can be powered-off. This time interval prevents the decoder from sending additional commands until the projector has had time to complete its cool-down process.

Timeout (s)

Enter the time interval, in seconds, before the next command can be accepted by the display.

Type

Click this drop-down list to select the display mode.

Type	Description
DispSW AVon	Display switches on/off, source audio/video signal always on.
DispSW AVSW	Display switches on/off, source audio/video signal switches on/off.
AV SW	Display is always on, source audio/video signal switches on/off
Always on	Display is always on, source audio/video signal always on.

Timeout (s) 0

Type DispSW AVon ▼

SAVE

SAVE

Click this button to commit all changes within the **Output** window group.

Logo page

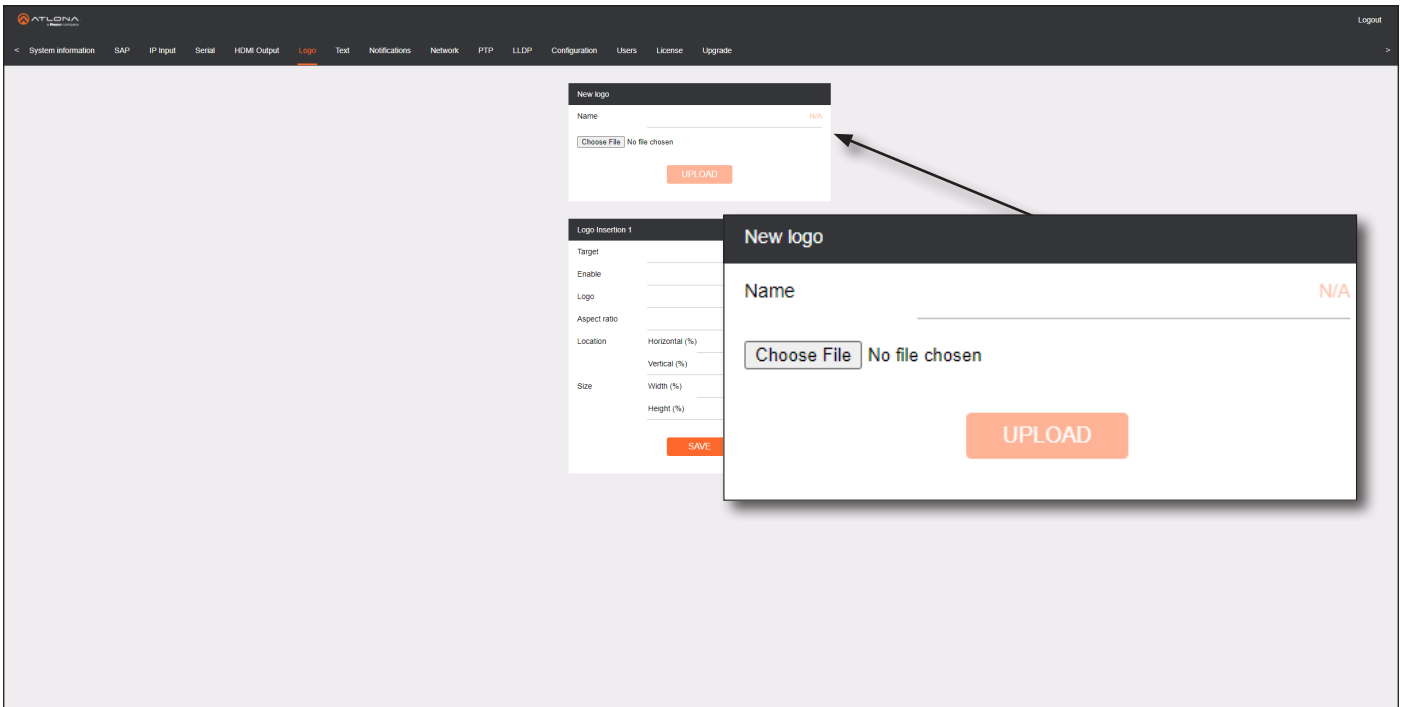

New logo window group

Name

Enter a name for the logo in this field.

Choose File

Click this button to select the logo file to be uploaded. Files must be in .png format and must not exceed 5 MB (5120000 bytes) in size. When an image file is uploaded, it will appear in the **Logo** drop-down list.

UPLOAD

Click this button to upload the logo file to the decoder.

Logo Insertion window group

Target

Displays the name of the encoder. This field cannot be changed.

Enable

Click the toggle switch to enable or disable the logo. If the toggle switch is orange, then the logo will be enabled.

Logo

Click this drop-down list to select the desired logo. To disable the use of a logo, set to **Not Used**.

Aspect Ratio

Click this drop-down list to select the type of aspect ratio to be applied to the logo.

Horizontal (%)

Enter the horizontal position of the logo on the screen. This value is based on the total horizontal resolution of the screen.

Logo Insertion 1	
Target	hdmi_output1
Enable	<input type="checkbox"/>
Logo	Not used ▼
Aspect ratio	stretch ▼
Location	Horizontal (%) 0

Vertical (%)

Enter the vertical position of the logo on the screen. This value is based on the total vertical resolution of the screen.

Width (%)

Enter the width of the logo. This value is based on the total horizontal resolution of the screen.

Height (%)

Enter the height of the logo. This value is based on the total vertical resolution of the screen.

SAVE

Click this button to commit all changes within the **Logo Insertion** window group.

	Vertical (%)	0
Size	Width (%)	10
	Height (%)	10
<input type="button" value="SAVE"/>		

Text page

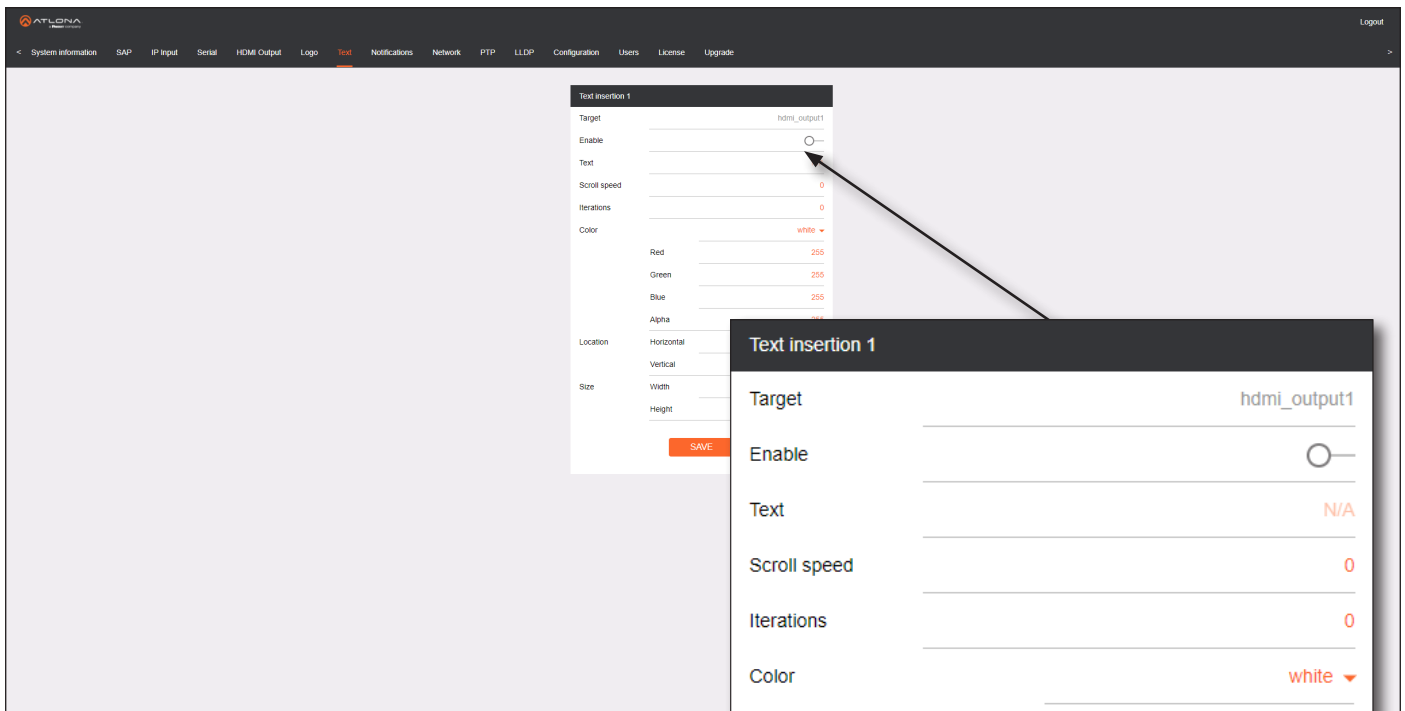

Text insertion window groups

Target

Displays the name of the output where the text will appear. This field cannot be changed.

Enable

Click this toggle switch to enable or disable the text. When the toggle switch is orange, the text will be enabled.

Text

Enter the desired text in this field.

Scroll Speed

Enter the scrolling speed in this field. Values from -255 to 255 are valid. Negative numbers will scroll the text from left to right. Positive numbers will scroll text from right to left.

Iterations

Enter the number of iterations in the **Iteration** field. Set this field to 0 (zero) to set the number of iterations to infinity.

Color

Click this drop-down list to select a solid color preset: **red, green, black, white, yellow, or blue.**

Red, Green, Blue, Alpha

Click these fields to fine tune the color of the text. Adjust the **Alpha** field to control the transparency of the text. An alpha value of 255 is opaque and a value of 0 is transparent. Numbers from 0 to 255 are valid for all fields.

Horizontal

Enter the horizontal position of the text in this field.

Vertical

Enter the vertical position of the text in this field.

Width

Enter the width of the text in this field. This value is based on the horizontal resolution of the screen.

Height

Enter the height of the text in this field. This value is based on the vertical resolution of the screen.

SAVE

Click this button to commit all changes within the **Text insertion** window group.

Location	Horizontal	<input type="text" value="0"/>
	Vertical	<input type="text" value="0"/>
Size	Width	<input type="text" value="10"/>
	Height	<input type="text" value="10"/>

Network page

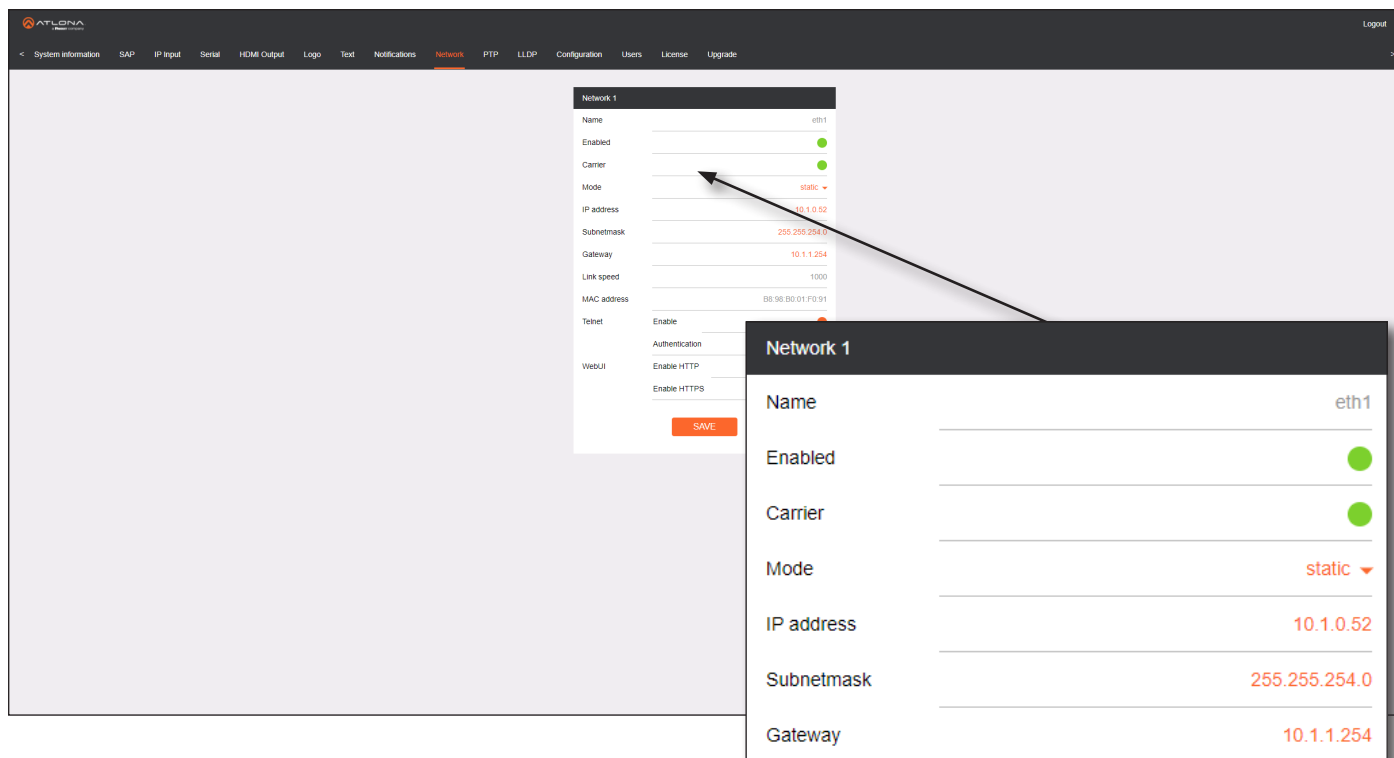

Network window groups

Name

Displays the name of the Ethernet interface. This field cannot be changed.

Enabled

This indicator displays whether or not the video stream for this channel is active. If the indicator is green, then the video stream is active.

Carrier

If this indicator is green, then an active link exists. Otherwise, if no link exists, this indicator will be red.

Mode

Click this drop-down list to select the desired IP mode. Select DHCP to let the DHCP server (if present) assign the encoder the IP settings; **Subnet** and **Gateway** fields will automatically be populated. When **Static** mode is selected, the information for the **IP Address**, **Subnet**, and **Gateway** fields must be entered.

IP Address

Displays the IP address used by the channel. This field can only be changed if **Static** mode is selected.

Subnetmask

Displays the subnet mask for the channel. This field can only be changed if **Static** mode is selected.

Gateway

Displays the gateway (router) address for the channel. This field can only be changed if **Static** mode is selected.

Link speed

Displays the Ethernet interface link speed in Mbps. This field cannot be modified.

MAC address

Displays the MAC address of the Ethernet interface.

Telnet Enable

Click this toggle switch to enable or disable Telnet. If disabled, then Telnet sessions to the encoder cannot be established.

Telnet Authenticator

Click this toggle switch to enable or disable Telnet authentication. If enabled, then the toggle switch will be orange. Once enabled, connecting to the encoder using Telnet will require login credentials. The default credentials are:

Username: admin
 Password: Atlona

WebUI Enable HTTP

Click this toggle switch to enable or disable HTTP. If disabled, traffic on port 80 is forbidden.

WebUI Enable HTTPS

Click this toggle switch to enable or disable HTTPS. If disabled, traffic on port 443 is forbidden.

SAVE

Click this button to commit all changes within the **Network** window group.

Link speed	1000
MAC address	B8:98:B0:01:F0:91
Telnet	Enable <input checked="" type="checkbox"/>
	Authentication <input checked="" type="checkbox"/>
WebUI	Enable HTTP <input checked="" type="checkbox"/>
	Enable HTTPS <input checked="" type="checkbox"/>
SAVE	

PTP page

The **PTP** page provides options for adjust Precision Time Protocol (PTP) for AES67 audio streams. PTP is used by AES67 to keep all audio streams synchronized.

For a system utilizing PTP, all devices undergo an automatic self-election process to choose the interface to be used as the PTP grandmaster (GM) clock, based on the accuracy of the device's clock and the device's configured priority. A lower priority number means the unit is more likely to get selected as GM.



IMPORTANT: If a new device is added to the network and the GM changes, a brief outage will be experienced while all connected devices synchronize with the new clock. Because of this, Atlona recommends that one unit gets manually defined as the GM and have both **Priority 1** and **Priority 2** fields be set to 1.

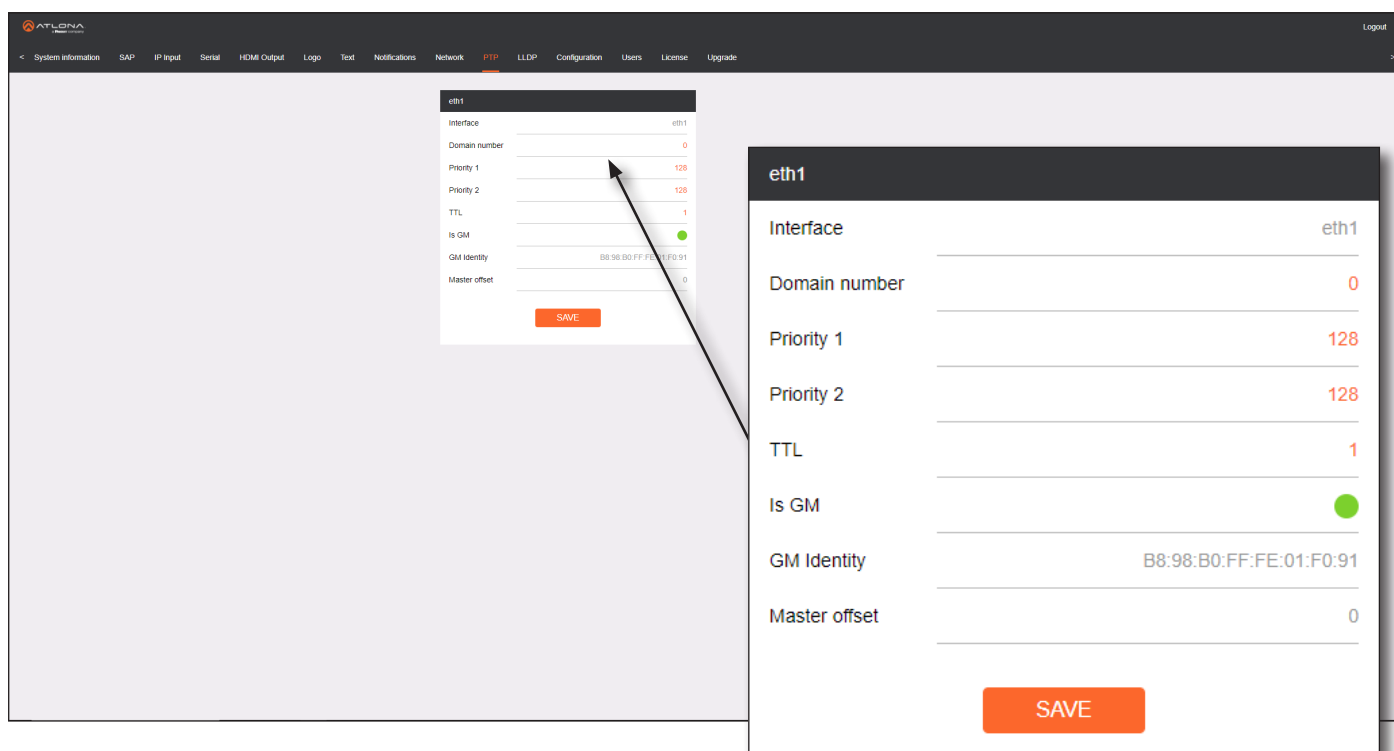

eth window group

Interface

Displays the Ethernet interface associated with the PTP settings.

Domain Number

Enter the domain number in this field. Valid entries are 0 through 127.

Priority 1

Enter the priority number in this field.

Priority 2

Enter the priority number in this field.

TTL

Displays the TTL value. PTP uses a default IPv4 TTL value of 1 for multicast. This value may be changed, if necessary, in order for the replies to reach the PTP monitor.

Is GM

This indicator displays the existence of a grandmaster clock for the specified PTP domain number. If the indicator is green, then the grandmaster clock exists on this interface.

GM Identity

The grandmaster clock identity. If this field is blank, then it means that this interface is the grandmaster clock.

Master Offset

Displays the grandmaster clock offset.

SAVE

Click this button to commit all changes within the **eth** window group.

LLDP page

The Link Layer Discovery Protocol (LLDP) page returns information about the switch that the encoder is connected to.



NOTE: LLDP must be enabled on the switch that the decoders are connected to, in order for the switch information to be displayed.

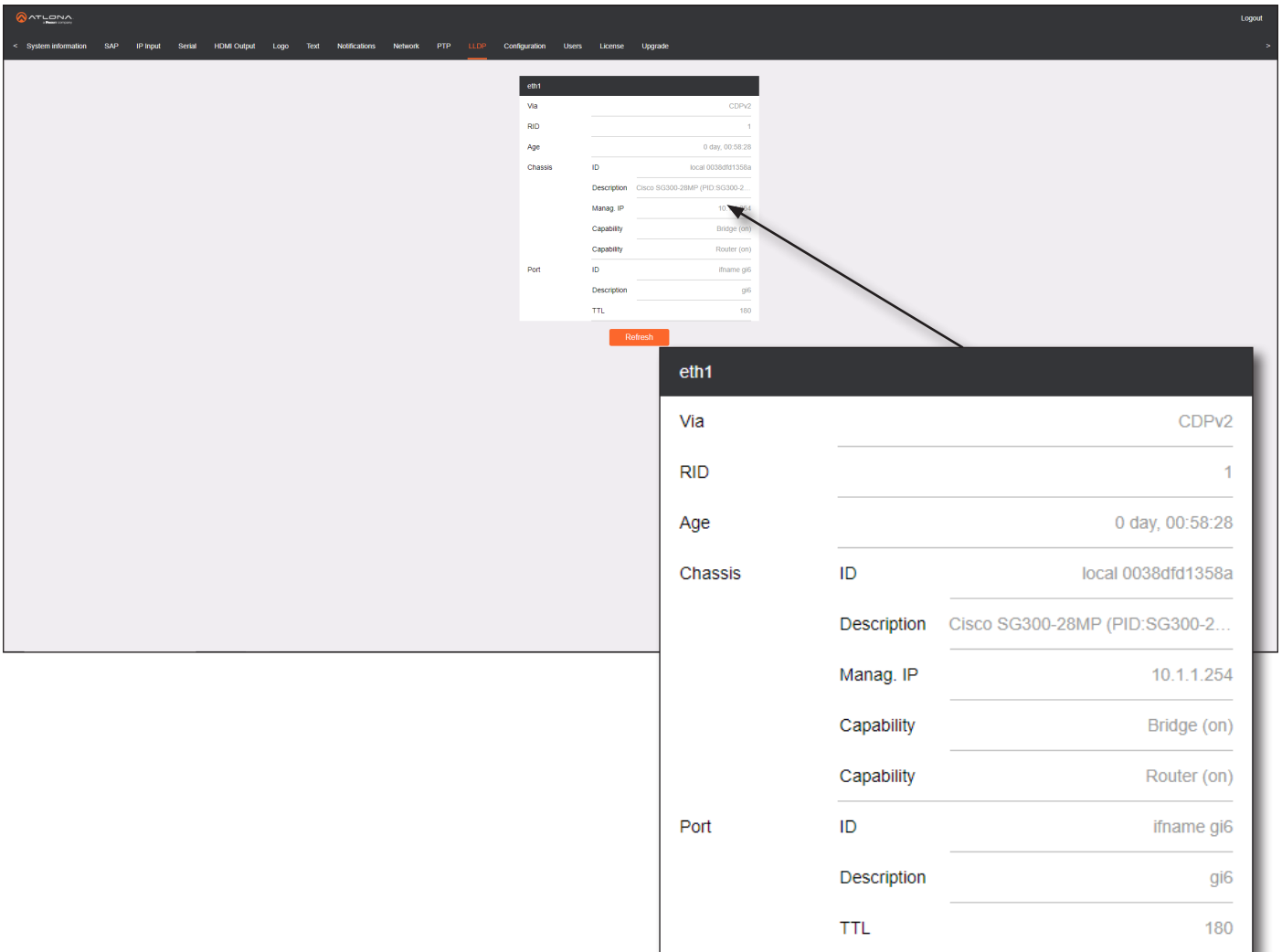

The screenshot shows the ATLONA web interface with the LLDP page selected. The main content area displays LLDP information for the interface 'eth1'. Below this information is a 'Refresh' button. A larger, detailed view of the 'eth1' data is shown in a separate window, which is a zoomed-in version of the data displayed in the main interface.

eth1	
Via	CDPv2
RID	1
Age	0 day, 00:58:28
Chassis	ID local 0038df1358a
Description	Cisco SG300-28MP (PID:SG300-2...
Manag. IP	10.1.1.254
Capability	Bridge (on)
Capability	Router (on)
Port	ID ifname gi6
Description	gi6
TTL	180

Configuration page

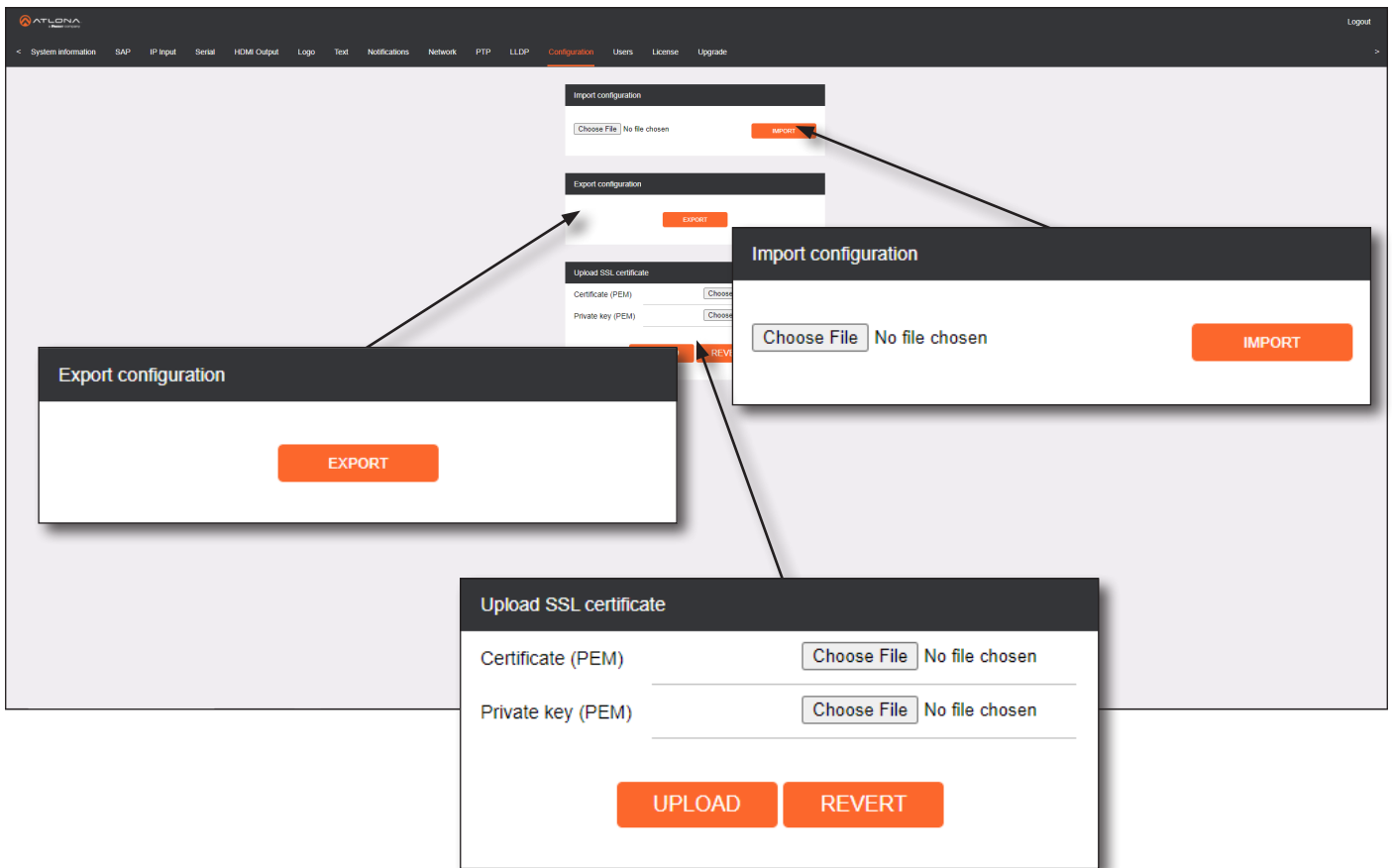

Import configuration

Choose File

Click this button to select the desired configuration file to be uploaded.

IMPORT

Click this button to upload the selected configuration file to the encoder.

Export configuration

EXPORT

Click this button to export the current encoder system configuration to a .json file.

Upload SSL certificate

Choose File

Click these buttons to select the desired certificate or private key.

UPLOAD

Click this button to upload the certificate/private key to the encoder.

REVERT

Click this button to restore the previous configuration.

Users page

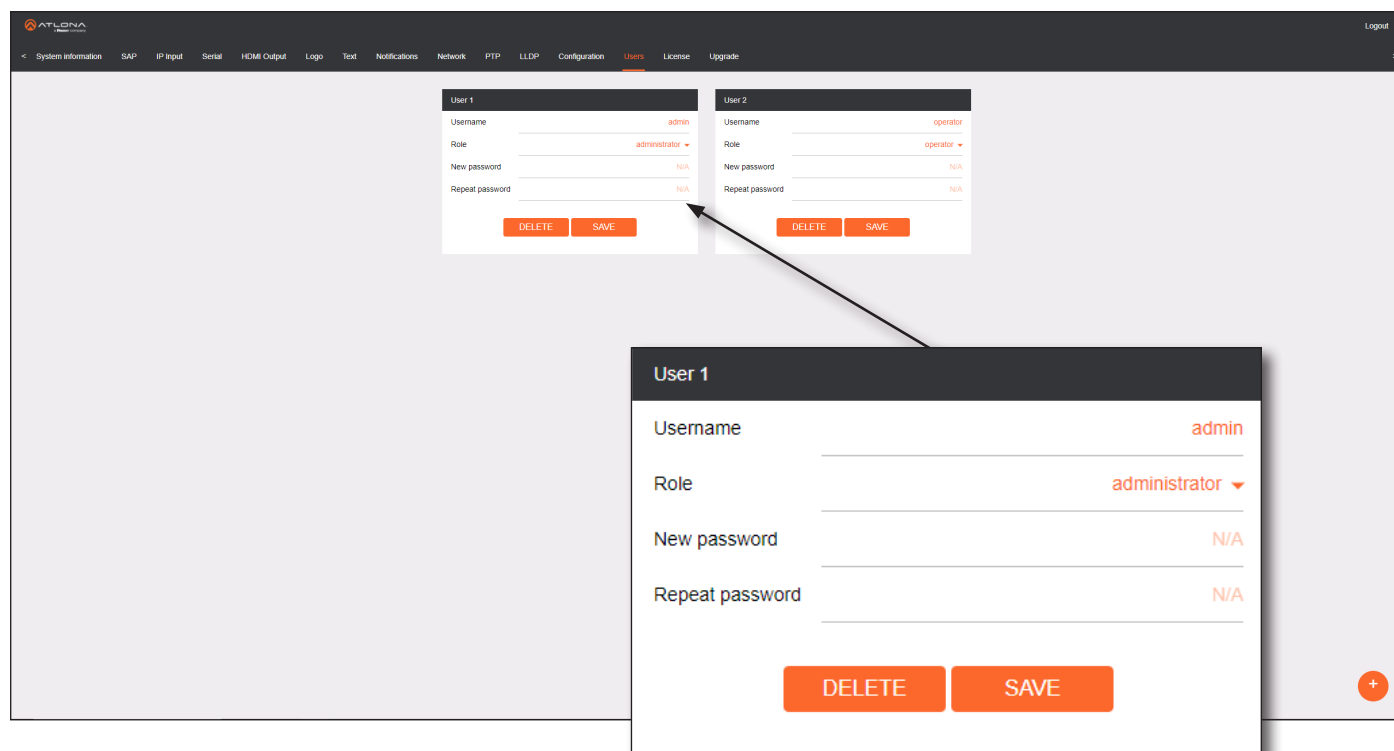

User window groups

The following fields apply to all **User** window groups. Decoders have two usernames, by default: **admin** and **operator**.

Username

Enter the desired username in this field.

Role

Click this drop-down list to select the desired role of the user.

New password

Enter the desired password for the username in this field.

Repeat password

Confirm the new password by entering it in this field.

DELETE

Click this button to delete the user in the current window group. Note that there must be at least one admin role at all times. Therefore, if one **admin** role and one **operator** role exist, then the **admin** user cannot be deleted.

SAVE

Click this button to commit all changes within the current user window group.

New user

Click this button to create a new user. Provide the role and password, as described in the fields above.

License page

This page displays all installed licenses and allows additional licenses to be installed.

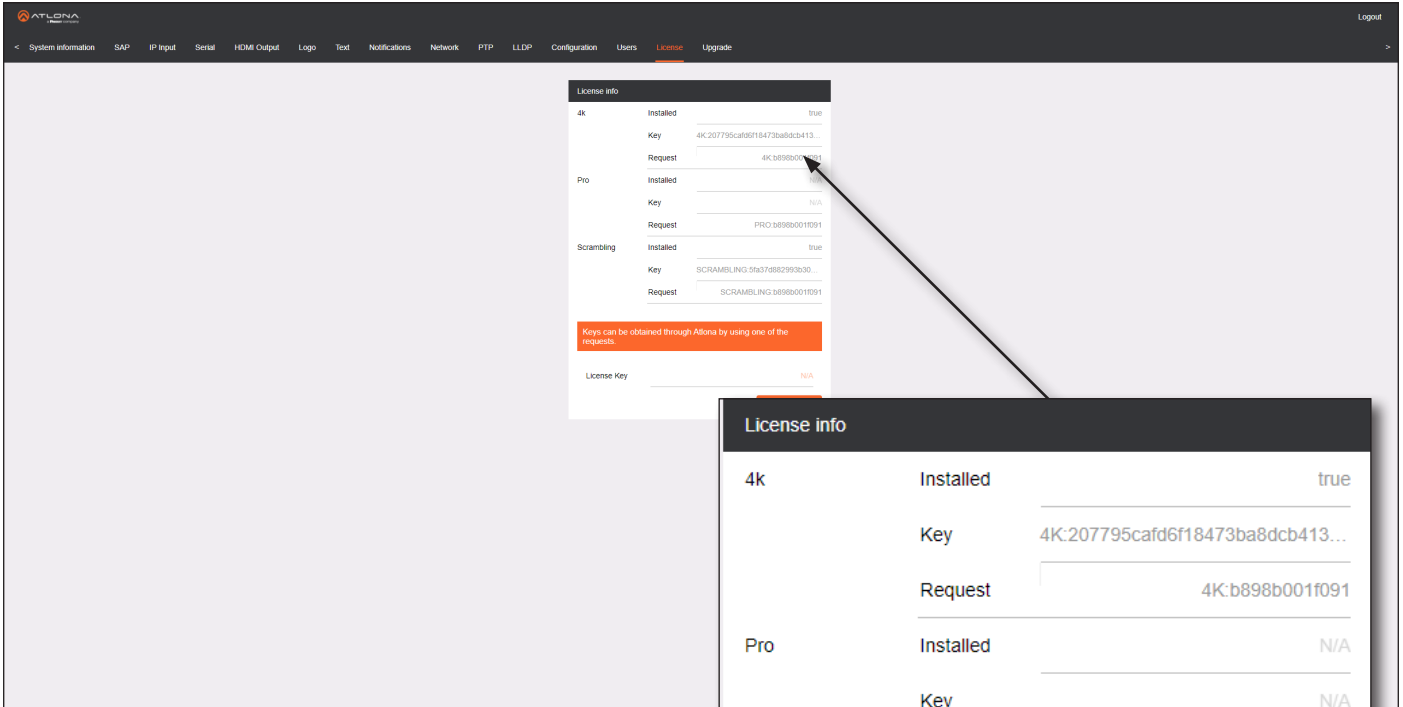

License Key

Enter the license key in this field.

INSTALL LICENSE

Click this button to validate and install the license.

License info

4k	Installed	true
	Key	4K:207795cafd6f18473ba8dcb413...
	Request	4K:b898b001f091
Pro	Installed	N/A
	Key	N/A
	Request	PRO:b898b001f091
Scrambling	Installed	true
	Key	SCRAMBLING:5fa37d882993b30...
	Request	SCRAMBLING:b898b001f091

Keys can be obtained through Atlona by using one of the requests.

License Key N/A

INSTALL LICENSE

Upgrade page

This page is used to update the firmware on the decoder.

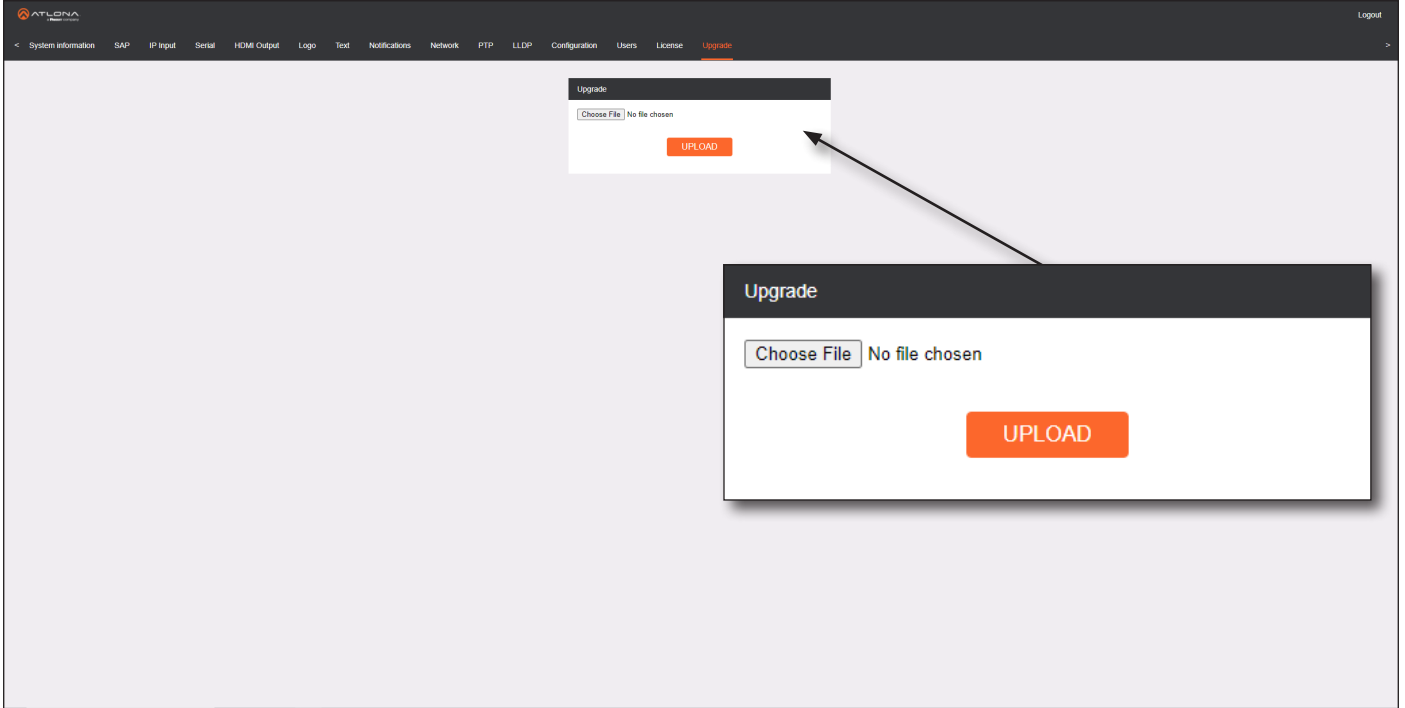

Choose File

Click this button to select the firmware file to be uploaded.

UPLOAD

Click this button to upload the selected firmware file.

Appendix

Updating the Firmware using Velocity™/AMS

IMPORTANT:



- If updating from version 1.0.x, OmniStream units must first be updated to version 1.1. Note that this does *not* apply to OmniStream R-Type units. If running version 1.0.x, contact an Atlona Technical Support Engineer before updating the firmware.
- When updating the firmware, make sure that the unit does not lose power. The firmware update process should take approximately 1 to 2 minutes.
- For full functionality of OMNI 1.2.1 (or later), Velocity must be running at least 1.4.5 and AMS must be on firmware version 2.0.12 and above.

1. Click **DEVICE INFO** in the menu bar.
2. Click the **UPDATE FIRMWARE** button to display the **Firmware Update** dialog.

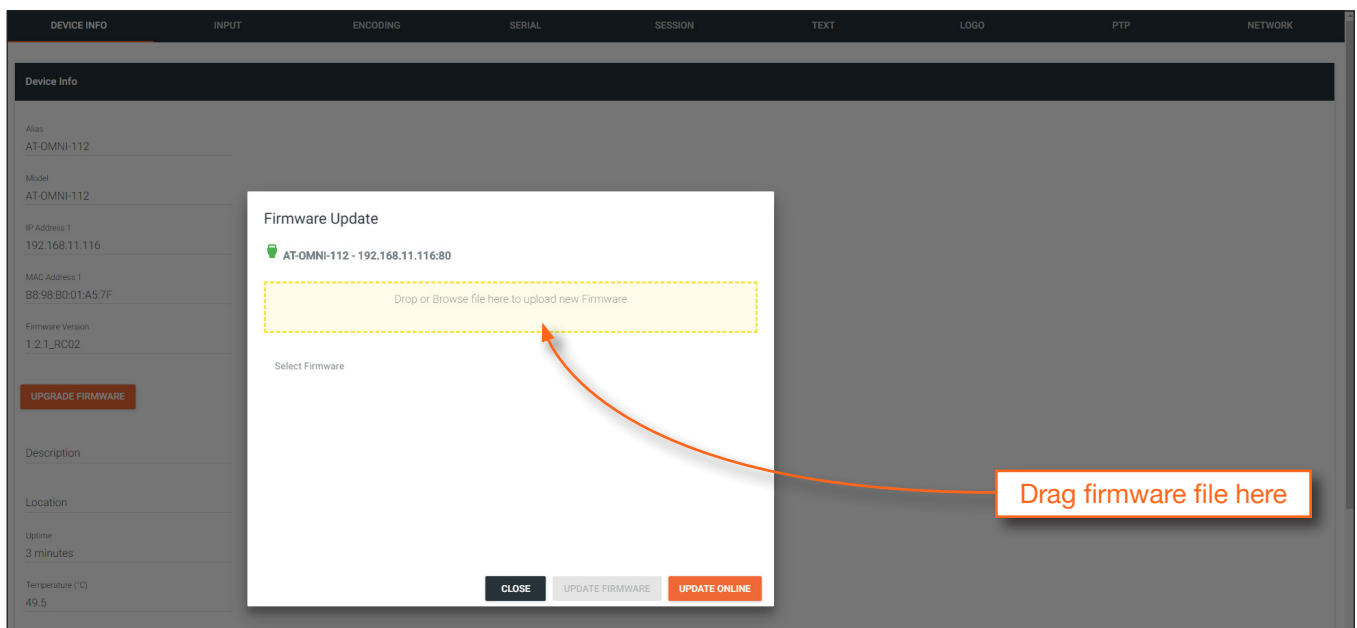

3. Click and drag the firmware file to the yellow box, to upload the firmware to the device. OmniStream firmware files use the .vpup2 file extension. Once the firmware file has been uploaded, it will appear under the **Select Firmware** section of the dialog box.
4. Click the **UPDATE FIRMWARE** button to begin the update process.

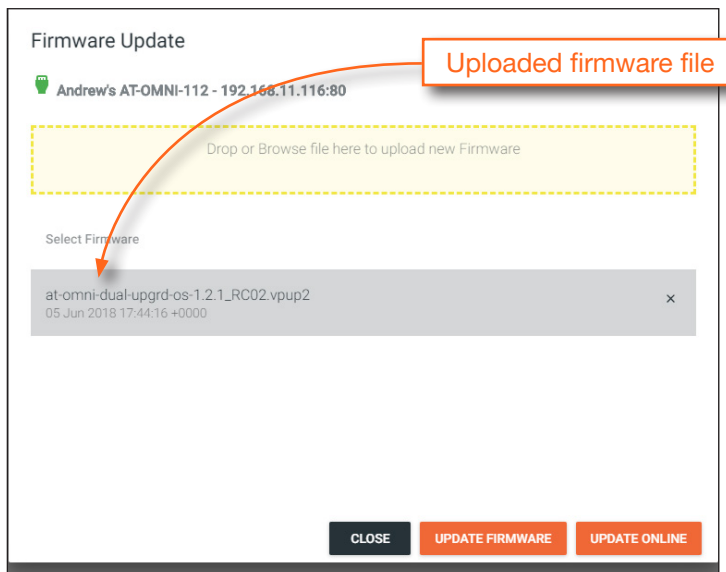

Firmware file	OmniStream SKU
at-omni-single-upgrd-os-[version].vpup2	AT-OMNI-111, AT-OMNI-121, AT-OMNI-111-WP
at-omni-dual-upgrd-os-[version].vpup2	AT-OMNI-112, AT-OMNI-122
at-omni-residential-upgrd-os-[version].vpup2	AT-OMNI-512, AT-OMNI-521

5. After the **UPDATE FIRMWARE** button is clicked, the Upgrade Firmware Started message box will be displayed.

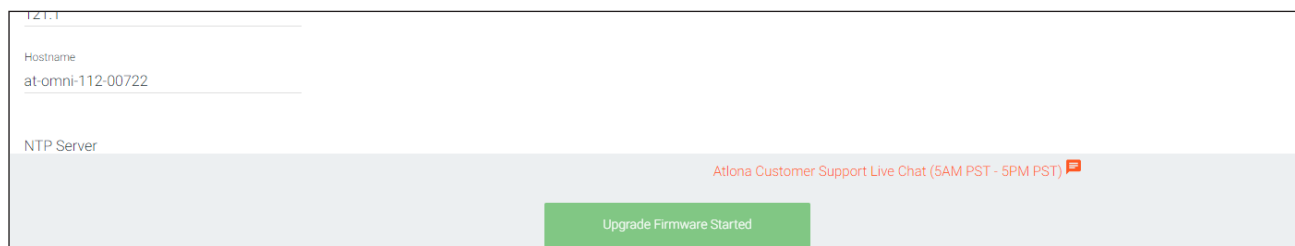

6. Click the orange up-arrow icon, in the upper-right corner of the screen, as shown below. If this icon is orange, it indicates that a firmware update is in progress.

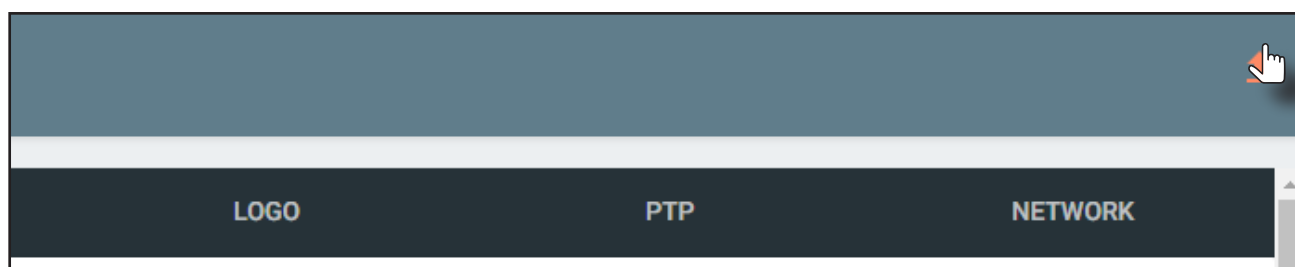

The progress bar for the update process will be displayed. The update process should take a few seconds.

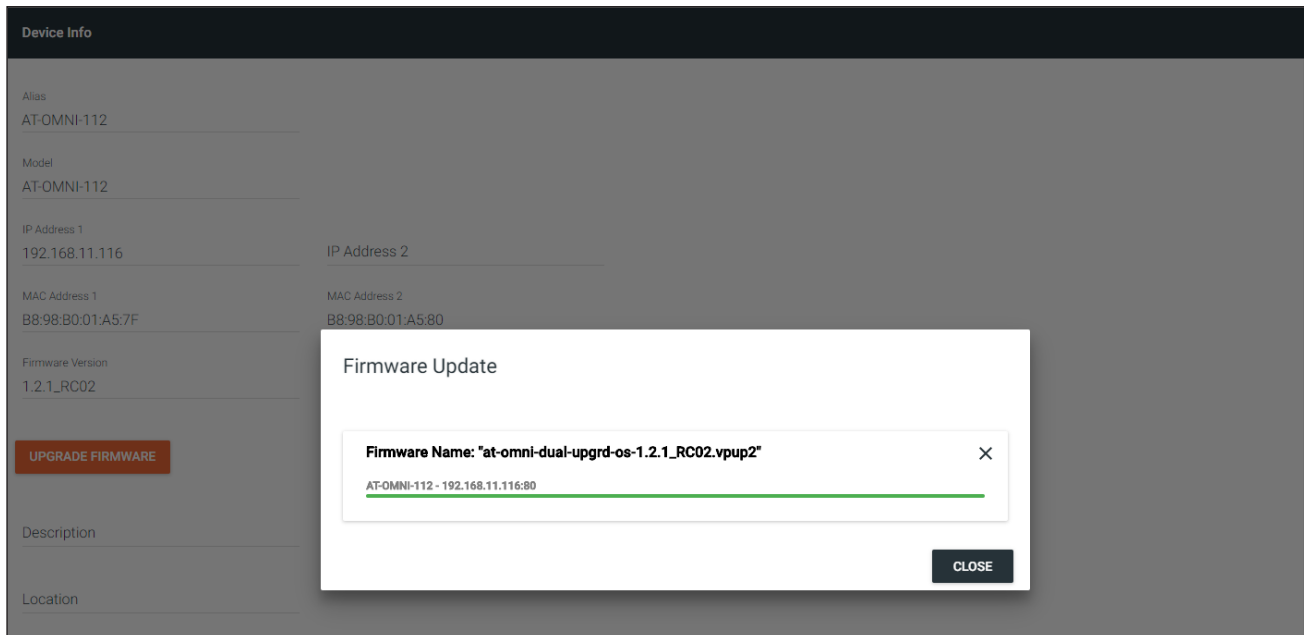

7. Click the "X" to close out the progress bar window, then click the **CLOSE** button to dismiss the **Firmware Update** message box.
8. The firmware update process is complete.
9. Clear the web browser cache and refresh the web page. The new firmware version will appear in the **Firmware Version** field, in the **DEVICE INFO** page.

Updating the Firmware using the Web Server

Follow the procedure below to update OmniStream units using the built-in web server.

1. Launch the desired web browser and enter the IP address of the encoder/decoder in the address bar.
2. Enter the username and password. Note that the password field will always be masked. The default credentials are:

Username: admin
 Password: Atlona

3. The **System Information** page will be displayed.
4. Click **Upgrade** in the menu bar to display the **Upgrade** page.
5. Click the **Choose File** button.

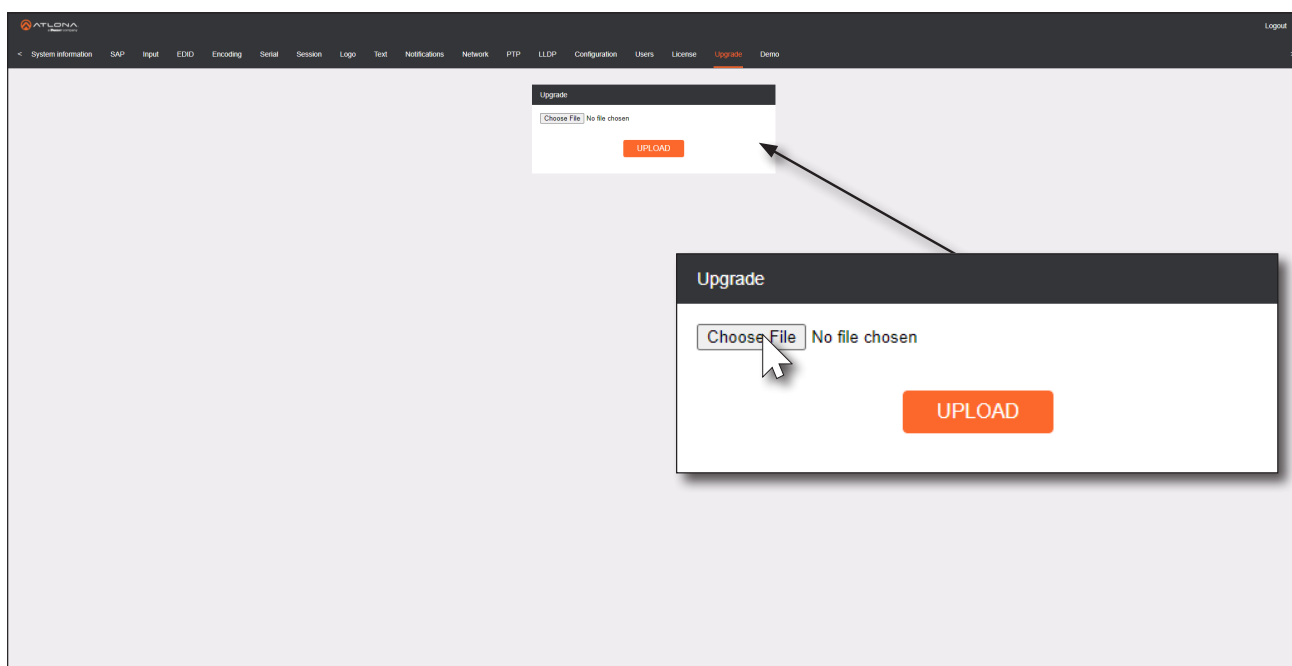

6. In the **Open** dialog box, select the correct firmware file. Refer to the table below.

Firmware file	OmniStream SKU
at-omni-single-upgrd-os-[version].vpup2	AT-OMNI-111, AT-OMNI-121, AT-OMNI-111-WP
at-omni-dual-upgrd-os-[version].vpup2	AT-OMNI-112, AT-OMNI-122
at-omni-residential-upgrd-os-[version].vpup2	AT-OMNI-512, AT-OMNI-521

7. Click the **UPLOAD** button.
8. A progress bar will be displayed, indicating the current upgrade status of the unit. When firmware update process has completed, the **Upgrade** page will be displayed.
9. The upgrade process is complete.

Mounting Instructions

The AT-OMNI-521 decoder includes two mounting brackets and four mounting screws, which can be used to attach the unit to any flat surface.

1. Using a small Phillips screwdriver, remove the two screws from the left side of the enclosure.

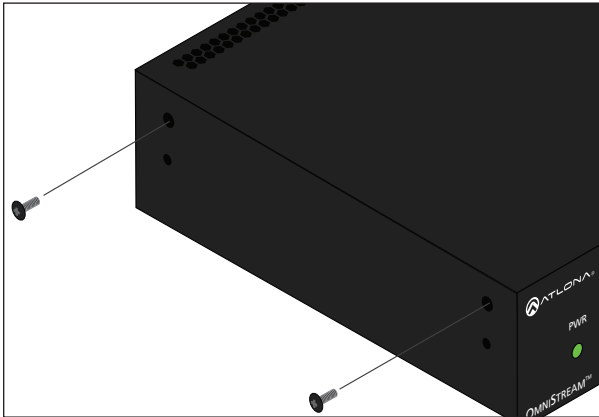

2. Position one of the rack ears, as shown below, aligning the holes on the side of the enclosure with one set of holes on the rack ear.
3. Use the enclosure screws to secure the rack ear to the enclosure.

Included screws

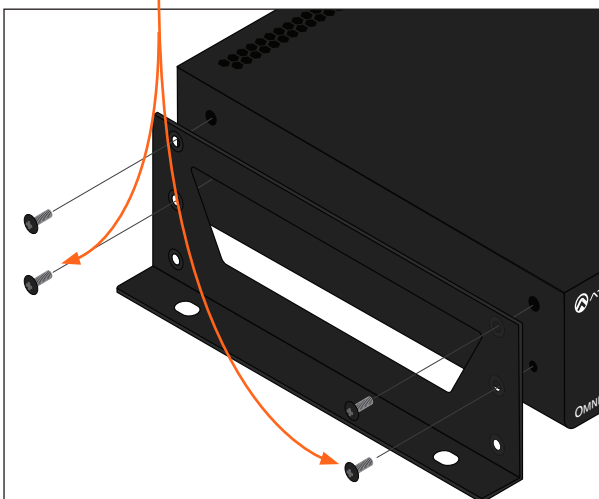

4. To provide added stability to the rack ear, use two of the included screws and attach them to the two holes, directly below the enclosure screws, as shown above.
5. Repeat steps 1 through 4 to attach the second rack ear to the opposite side of the unit.

6. Mount the unit using the oval-shaped holes, on each rack ear. If using a drywall surface, a #6 drywall screw is recommended.

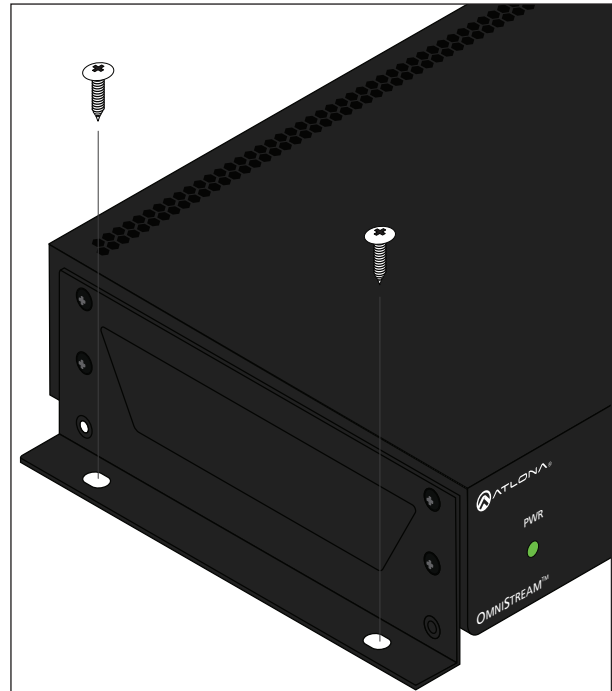

NOTE: Rack ears can also be inverted to mount the unit under a table or other flat surface.

Rack Tray for OmniStream

OmniStream decoders can also be mounted in the OmniStream rack tray (AT-OMNI-1XX-RACK-1RU). The rack tray is sold separately and provides easy mounting and organization of up to two OmniStream encoders/decoders in a convenient 1U rack tray. The OmniStream rack tray can be purchased directly from Atlona.

1. Position the OmniStream products, as shown in the illustration below.
2. Using the included screws, secure each unit to the rack with a Philips screwdriver.



NOTE: OmniStream units can be mounted forward-facing or back-facing, depending upon your requirements.

3. Install the entire assembly into an empty 1U slot in the rack.

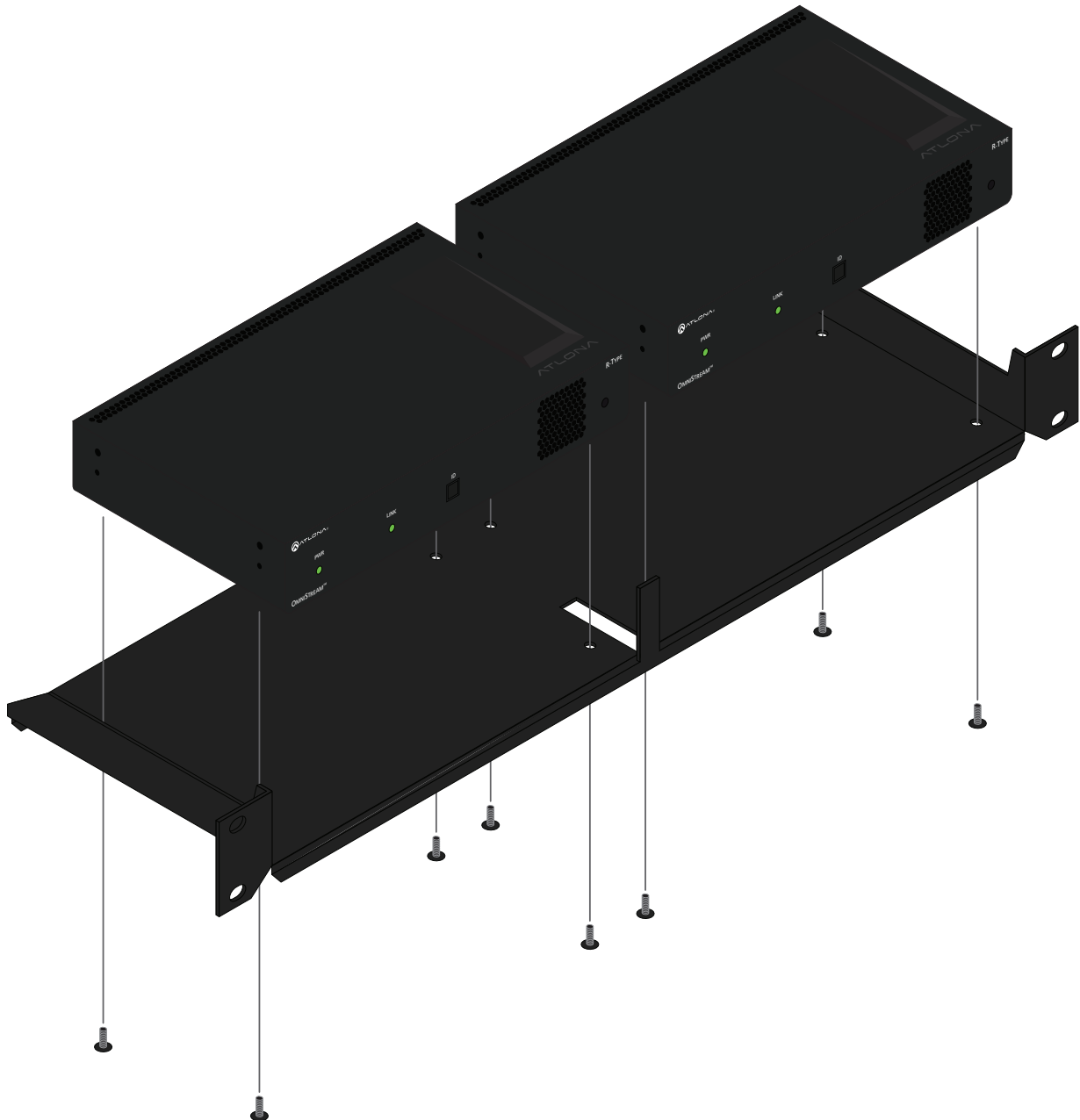

Specifications

Video		
HDMI Specification	HDMI 2.0b, HDCP 2.2	
UHD/HD	4096x2160 (DCI) @ 60/30/24 Hz 3840x2160 (UHD) @ 60/50/24/25/30 Hz 1080p @ 23.98/24/25/29.97/30/50/59.94/60 Hz	1080i ⁽¹⁾ @ 25/29.97/30 Hz 720p @ 30/50/59.94/60 Hz
VESA ⁽²⁾	2560x1600 1920x1200 1680x1050 1600x1200 1600x900 1440x900 1400x1050	1366x768 1360x768 1280x1024 1280x800 1280x768 1152x768 1024x768
Color Space	YUV, RGB	

Decoding	
Density	One decoding engine
Decoding Format	VC-2 (SMPTE-2042)
Video Quality Optimization	Motion Video
Color Depth	8-bit, 10-bit, 12-bit
HDR	HDR10, HLG, Dolby® Vision™
Bit Rate	900 Mbps
Latency	0.5 frame (e.g. 1080p @ 60 Hz latency is < 8 ms between encoder and decoder) 1.5 frames in Fast Switching mode (e.g. 1080p @ 60 Hz latency is < 24 ms between encoder and decoder) Note: Unusual network configurations may increase overall latency
Output Resolution in Ultra-Fast Switching Mode	1080p @ 60 Hz

Audio	
Pass-through	LPCM 2.0, LPCM 5.1, LPCM 7.1, Dolby® Digital, Dolby Digital Plus, Dolby TrueHD, Dolby Atmos®, DTS®, DTS-HD Master Audio™
Down-mixing	Multichannel LPCM to two-channel LPCM
Sample Rate	32 kHz, 44.1 kHz, 48 kHz, 88.2 kHz, 96 kHz, 176.4 kHz, 192 kHz
Bit Depth	Up to 24-bit

Protocols	
Video Streaming	RTP
Audio Streaming	RTP, up to 7.1 channels AES67, up to LPCM 7.1 channels
Addressing	DHCP, static
Encryption	AES-128
QoS Tagging	RFC 2475
Discovery	Multicast DNS, LLDP, SAP
Management	HTTPS, SSH, Telnet, and WebSockets with TLS
IP Multicast	IGMPv2 and IGMPv3 support

Graphics Features	
Text Insertion	Adjustable height/width, scrolling (speed, direction, or static), iterations (up to infinite), positioning, and adjustable color and alpha (transparency) channels.
Slate / Logo Insertion ⁽³⁾	PNG file format, adjustable aspect ratio (keep or stretch), horizontal/vertical size, screen position; slate mode can be set to off, manual (image always displayed, superimposed on the source signal, and will remain if source signal is lost), auto (image will only be displayed when source signal is lost).

Control	
CEC	Supported and triggered from control systems and OmniStream encoders
RS-232	Device control and configuration; supports baud rates from 2400 to 115200 Bidirectional pass-through from control system to network Bidirectional TCP Proxy (RS-232 commands over IP)
IR	Pass-through from control system to network Pass-through from network to control system

Connectors	
HDMI	1 - Type A, 19-pin, female, locking
ETHERNET ⁽⁴⁾	1 - RJ45, 10/100/1000 Mbps
RS-232 / IR	1 - Euroblock, 6-pin (2 ports); RS-232 on port 1 and 2, IR on port 2 only

Indicators and controls	
PWR	1 - LED, tricolor (red, amber, green)
LINK	1 - LED, bicolor (red, green)
ID	1 - Momentary, tact-type, backlit (blue); sends an identification broadcast message over the network to any listening devices.
Reboot	1 - Momentary, tact-type

Power	
PoE	IEEE 802.3af
Consumption	Up to 12 W

Environmental	
Cooling System	Front-to-rear airflow, temperature-controlled fans
Operating Temperature	+14 to +122 °F -10 to +50 °C
Storage Temperature	-14 to +140 °F -10 to +60 °C
Operating Humidity (RH)	20% to 95%, non-condensing

Chassis	
Dimensions (H x W x D)	1.34 in x 8.19 in x 4.41 in 34 mm x 208 mm x 112 mm
Weight	1.5 lbs / 0.7 kg

Certification	
Device	CE, FCC, CB, RoHS

(1) Scaling and deinterlacing is not supported at 1080i.

(2) All VESA resolutions are 60 Hz.

(3) Slate insertion is limited to 1080p only.

(4) Maximum distance per hop is 330 feet (100 meters), depending upon network configuration.

